



# AllWell Instruments co.

The name of Health Cure Instruments

## ORTHOPEDIC INSTRUMENTS



Develops and offers an array of unique, high quality instruments and positioning devices designed for orthopedic surgery, with a focus on tools to enhance and increase operating room efficiency.



[www.allwellinst.com](http://www.allwellinst.com)



**AllWell Instruments co.**

The name of Health Cure Instruments





# AllWell Instruments co.

The name of Health Cure Instruments

## INDEX

<u>PARTICULARS</u>	<u>PAGE</u>
1) ORTHOPEDIC DRESSING – PLASTER INSTRUMENTS	01-03
2) AMPUTATION SAW – GIGLI SAW	04-05
3) REAMERS – AWLS – BONE HOOKS	06-07
4) ORTHOPEDIC HAND BONE DRILLS & ACCESSORIES	08-11
5) BONE HOLDING CLAMPS – TRACTION BARS	12-13
6) MISC GRIPS – NOSE PLIERS – SLAP HAMMERS	14-15
7) NOSE PLIERS – PULLING FORCEPS – WIRE CUTTERS	16-18
8) PLIERS – BENDERS – ROD INSTRUMENTS	19-20
9) WIRE INSTRUMENTS – EXTENSION BOWS	21-23
10) RING CUTTERS – LEAD HANDS – BIPOSY TOOLS	24-25
11) BONE TEMPERS – IMPACTORS – PACKERS	26
12) BONE RASPS – FILES	27-30
13) BONE LEVERS – RETRACTORS	31-37
14) CHISELS – OSTEOTOMES – GOUGES	38-43
15) BONE CURETTES	44-49
16) PERIOSTEAL ELEVATORS – DISSECTORS	50-54
17) ORTHOPEDIC MALLETS & ELEVATORS SPINAL S/S & SPINAL	55-58
18) TENDON INSTRUMENTS	59-62
19) PELVIC REDUCTION FORCEPS	63-64
20) BONE HOLDING FORCEPS	65-72
21) REPOSITION – CARTILAGE FORCEPS	73
22) BONE CUTTING FORCEPS	74-77
23) BONE RONGEURS – NIBBLERS	78-88
24) RIB SHEARS	89-90
25) LAMINA SPREADERS – RETRACTORS	91-97
26) CALCANEAL LAMBERDI SPREADERS	93
27) COMPRESSORS – DISTRACTORS	94-95
28) ROD BENDERS	96
29) CARBIDE WIRE – PIN CUTTING PLIERS	97-100
30) CARBIDE INSERTED SURGICAL SCISSORS	101-102
31) INSTRUMENTS FOR TRAUMATOLOGY	103-115





# AllWell Instruments co.

The name of Health Care Instruments

ORTHOPEDIC DRESSING PLASTER INSTRUMENTS

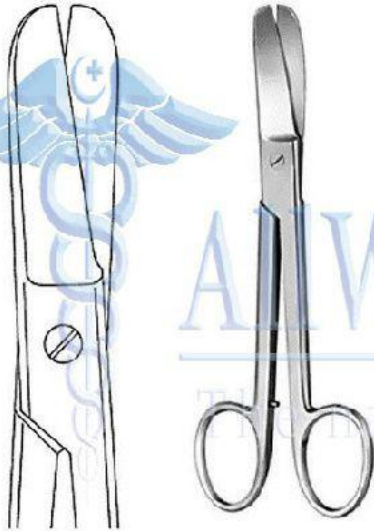

**11-01-0300**

Lorenz Bandage Scissors  
Heavy Pattern 23 cm / 9"

Also available  
in 18.5 cm / 7 1/4"  
& 20 cm / 8"

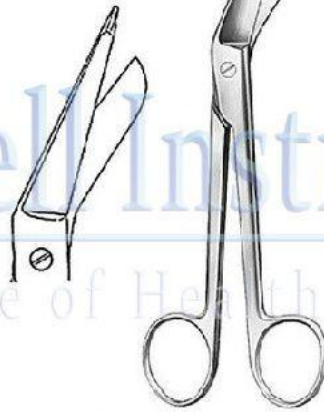

**11-01-0301**

Lister Bandage Scissors  
14.5 cm / 5 3/4"



**11-01-0302**

Bergmann Plaster Shears  
Heavy Pattern 23.5 cm / 9"



**11-01-0303**

Esmarch Plaster Shears  
Heavy Pattern, Short Blades  
20 cm / 8"

Also available  
in 18cm / 7 1/2"



**11-01-0304**

Bandage Scissors  
16cm / 6 3/4" Black Plastic Rings



**11-01-0305**

Bruns Plaster Scissors 24 cm  
9 1/2" One Serrated Cutting Edge





# AllWell Instruments co.

The name of Health Cure Instruments  
ORTHOPEDIC DRESSING - PLASTER INSTRUMENTS



Also Available  
26 cm / 10"  
38 cm / 15"

**11-01-0306**

Stille-Martin Plaster Shears  
23 cm / 9"



**11-01-0307**

Engel Plaster Saw 15.5 cm / 6"



**11-01-0308A**

Engel Plaster Saw 15.5 cm / 6"



**11-01-0308B**

Bergmann Plaster Saw 18 cm / 7"



**11-01-0309** Reiner Plaster Knife 18 cm / 7"



**11-01-0311** Hopkins Plaster Knife 20 cm / 8"



**11-01-0310** Esmarch Plaster Knife 18 cm / 7"



with wooden handle

**11-01-0312** Martin Plaster Knife 21 cm / 8 1/4"



# AllWell Instruments co.

The name of Health Cure Instruments

ORTHOPEDIC DRESSING - PLASTER INSTRUMENTS

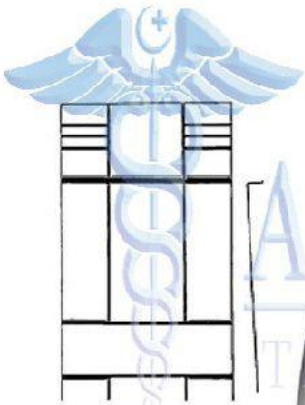

**11-01-0313**

Hermann Plaster Spreader  
48 cm / 19" Heavy Pattern



**11-01-0314**

Hennig Plaster Spreader  
28 cm / 11"



**11-01-0315**

Hennig Plaster Spreader  
30 cm / 12"



**11-01-0316** Beeson Plaster Spreader 1.5 in Blade 30 cm / 12"

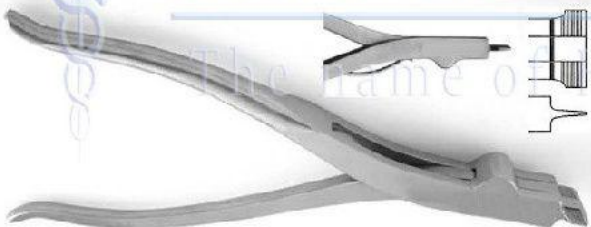

**11-01-0317** Walton Plaster Spreader w/Spring 3 Prongs 23 cm / 9"

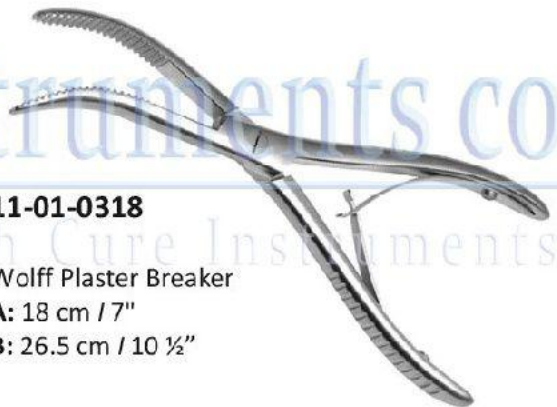

**11-01-0318**

Wolff Plaster Breaker  
A: 18 cm / 7"  
B: 26.5 cm / 10 1/2"





# AllWell Instruments co.

The name of Health Cure Instruments

## AMPUTATION SAW – GIGLI SAW



**11-01-0319**

Lister Bandage Scissors TC  
18 cm / 7" cm / 13 3/4"



**11-01-0320**

Bruns Plaster Scissors  
24 cm / 9 1/2"

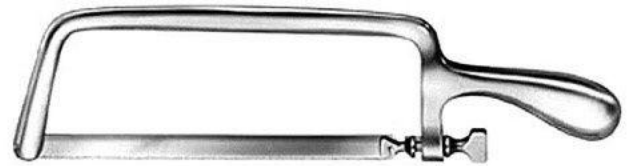

**11-01-0321**

Charriere Amputation Saw 35 cm / 13 3/4"



A: 21.5 cm / 8 3/4" 12mm



B: 21.5 cm / 8 3/4" 15mm



C: 21.5 cm / 8 3/4" 18mm

Spare Saw Blades



**11-01-0322**

BIER Amputation Saw 40.5 cm / 16"



A: 27 cm / 10 3/4" 4 mm wide



B: 27 cm / 10 3/4" 6 mm wide



C: 27 cm / 10 3/4" 8 mm wide



**11-01-0323**

Langenbeck Amputation Saw 24.5 cm / 9 3/4"



**11-01-0324** Satterlee Amputation Saw

29 cm / 11 1/2"



**11-01-0325** Charriere Amputation Saw 27 cm / 10 1/2"



**11-01-0326** Satterlee Amputation Saw 23 cm / 9"



# AllWell Instruments co.

The name of Health Cure Instruments

AMPUTATION SAW – GIGLI SAW



Right

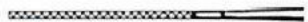

Straight



Left

**11-01-0327** Joseph Amputation Saw 18 cm / 7"

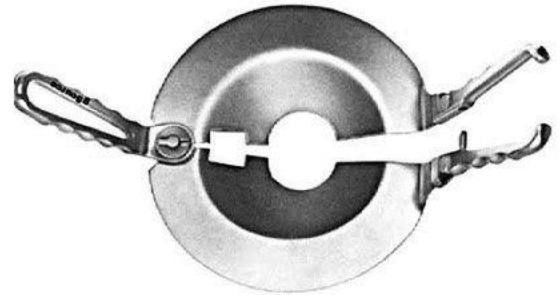

**11-01-0328**

Percy Amputation Shield 30 cm / 12"



**11-01-000**

- A:** Gigli Saw 30cm
- B:** Gigli Saw 50cm
- C:** Tyler Gigli Saw (Large Cut) 30cm
- D:** Tyler Gigli Saw (Large Cut) 30cm



**Gigli Saw Handles SOLID**

**11-01-001** Gigli Sold in Pair

**11-01-002** Gigli Sold in Pair



**11-01-005** BAILEY GIGLI SAW GUIDE 30 CM



**11-01-006** POPPEN GIGLI SAW GUIDE 28 CM



**11-01-003** Gigli Sold in Pair



**Gigli Saw Handles SOLID**

**11-01-004** Gigli Sold in Pair







# AllWell Instruments co.

The name of Health Cure Instruments

REAMERS - AWLS - BONE HOOKS



**11-01-0329**

Reamer  
13.5cm / 5 1/4"



**11-01-0330**

Perthes Reamer  
18 cm / 7"



**11-01-0331**

Perthes Reamer  
21.5 cm / 8 1/2"



**11-01-0332**

Reamer One concave  
side 14 cm / 5 1/2"



**11-01-0333**

Glenoid Punch  
20 cm / 8"

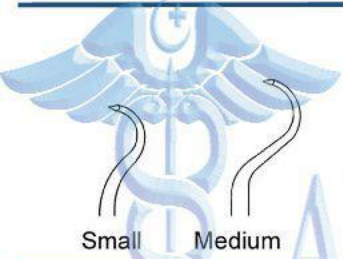

Small Medium Large



**11-01-0334**

Shoulder Percussion Awl - A: 21.5cm / 8 1/2" B: 23.5cm / 9 1/4"



A: 20cm / 8"  
19X27mm  
Sharp



B: 23cm / 9"  
15X20mm  
Blunt



C: 23cm / 9"  
15X20mm  
Sharp



C: 25cm / 9 3/4"  
15X20mm  
Sharp



**11-01-0335** Volkman Bone Hook



# AllWell Instruments co.

The name of Health Cure Instruments

REAMERS - AWLS - BONE HOOKS

Pointed



11-01-0336

Kuntscher Diamond Awl 28 cm / 11"

Pointed

11-01-0337

Rush Awl / Reamer

A: 19 cm / 7 1/2" 2.5mm

B: 21 cm / 8 1/4" 3mm

C: 21 cm / 8 1/2" 5mm

D: 26 cm / 10 1/2" 6mm

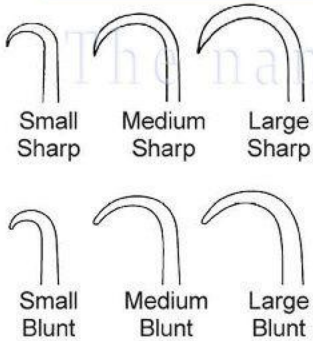
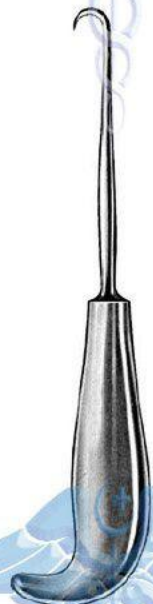

11-01-0338

Bone Hook 23 cm / 9"

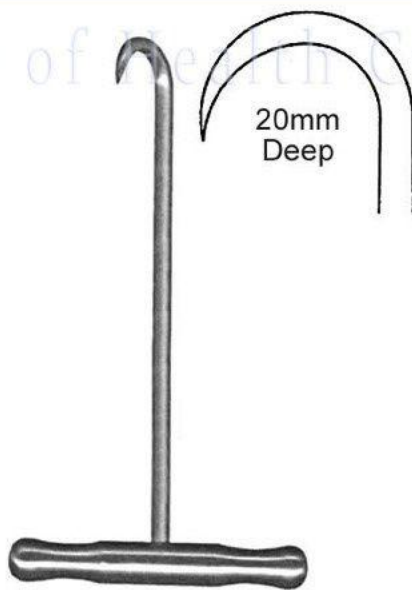

20mm Deep

11-01-0339

Bone Hook T Handle 20 cm / 8"



20mm Deep

11-01-0340

Bone Hook T Fiber Handle 14cm / 5 5/8"

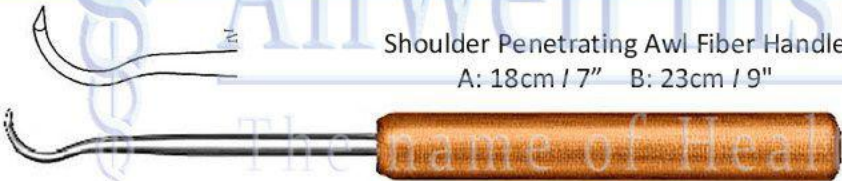

Shoulder Penetrating Awl Fiber Handle

A: 18cm / 7" B: 23cm / 9"

11-01-0341



11-01-0342

Pointed Awl Fiber Handle 25cm / 10"





# AllWell Instruments co.

The name of Health Cure Instruments

## ORTHOPEDIC HAND BONE DRILLS -ACC

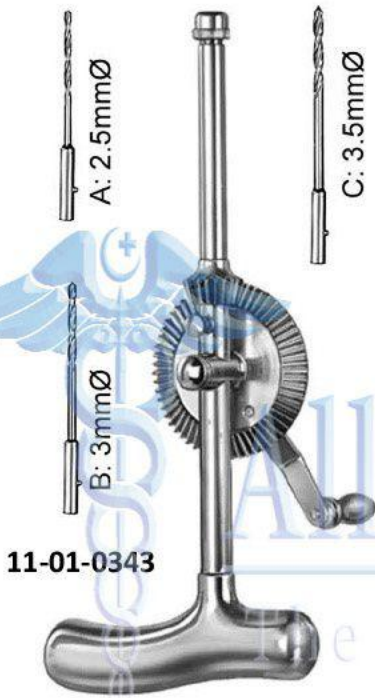

**11-01-0343**

Stille-Sherman Hand Drill  
24 cm / 9 1/2" with 3 twist drills

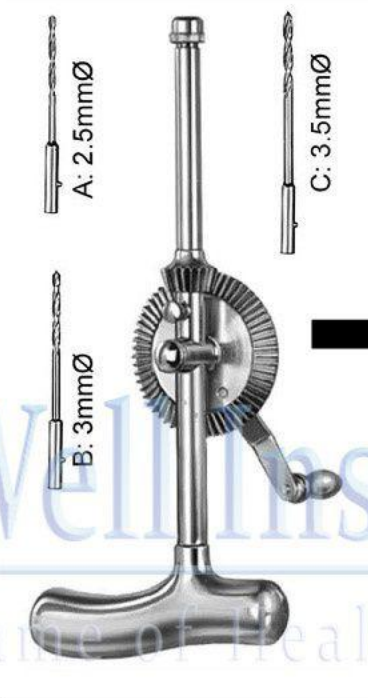

**11-01-0344** Stille Hand Drill 20.5 cm / 8" w / 9 Twist Drills

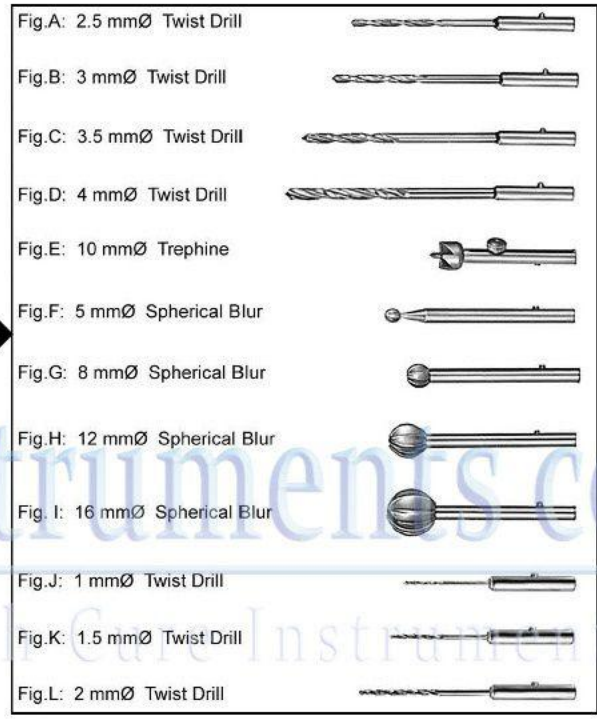

- Fig.A: 2.5 mmØ Twist Drill
- Fig.B: 3 mmØ Twist Drill
- Fig.C: 3.5 mmØ Twist Drill
- Fig.D: 4 mmØ Twist Drill
- Fig.E: 10 mmØ Trephine
- Fig.F: 5 mmØ Spherical Blur
- Fig.G: 8 mmØ Spherical Blur
- Fig.H: 12 mmØ Spherical Blur
- Fig.I: 16 mmØ Spherical Blur
- Fig.J: 1 mmØ Twist Drill
- Fig.K: 1.5 mmØ Twist Drill
- Fig.L: 2 mmØ Twist Drill

- Conical Burr Fig.1: 9 mmØ
- Conical Burr Fig.2: 14 mmØ
- Spherical Burr Fig.3: 16 mmØ
- Spherical Burr Fig.4: 22 mmØ
- Extension Piece Fig.9

**11-01-0345**

Hudson Hand Drill  
28 cm / 11"  
Complete with burrs Fig #. 1 - 4  
& additional price for additional  
accessories



Flat Trephine Fig.5: 14 mmØ

Twist Drill Fig.6

Burr Fig.7

Burr Fig.7

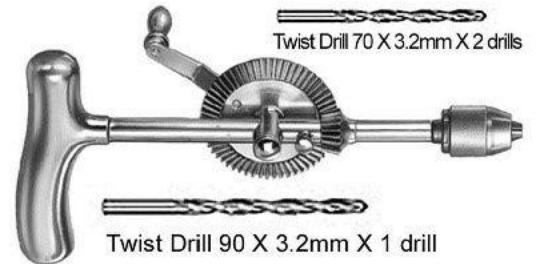

**11-01-0346** Moore Hand Drill  
Complete with a set of 3 twist drills

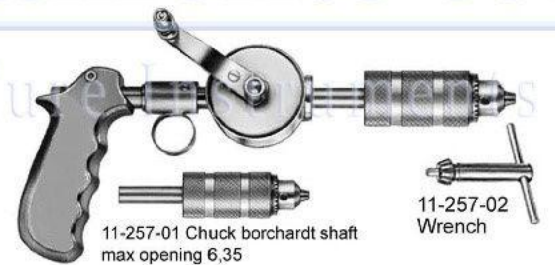

**11-01-0347**

Martin Hand Drill with Chuck & Wrench



# AllWell Instruments co.

The name of Health Cure Instruments

ORTHOPEDIC HAND BONE DRILLS -ACC

**11-01-0348**

Bunnell Hand Drill  
16cm / 6-1/4"



Longitudinally Bored with 3-Jaw-Chuek  
Light Metal Housing opening up to 4mm

**11-01-0349**

Bunnell Hand Drill  
16cm / 6-1/4"



Twin Shade Powder Coated Longitudinally  
bored with 3-Jaw-Chuek light metal  
housing opening up to 4mm



**11-01-0350**  
Ralk Hand Drill

Light Metal Housing  
Literally Angled Handle with 3-Jaw-Chuek  
and key, opening up to 6,35mm

**11-01-0351**

HAND DRILL  
All Covered Polished / Dull or Coated.  
Drills Holder at Bottom.



**11-01-0352**

Hand Drill  
All Covered Light Weight / Polished /  
Dull or Coated. Key Holder and Self  
Retaining Locking Mechanism



**Box for Hand Drills**  
Outside Artificial Leather  
/ inside Jumbo Foam



**11-01-0353**

Hand Drill  
Polished / Dull or Coated. Operated  
Horizontally and Vertically



**11-01-0354**

Hand Drill  
Polished / Dull or Coated.  
All Covered

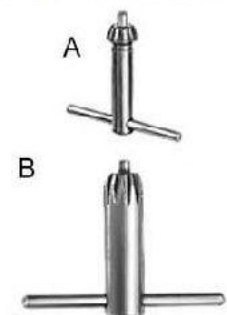

All Hand Drills  
Provided with Keys





# AllWell Instruments co.

The name of Health Cure Instruments

ORTHOPEDIC HAND BONE DRILLS -ACC



**11-01-0355**

Hand Drill  
Polished / Dull  
Or Coated.  
Open Housing



**11-01-0356**

Hand Drill  
Polished / Dull  
Or Coated.  
Open Housing



**11-01-0357**

Hand Drill  
Polished / Dull  
Or Coated.  
Semi Closed Housing



**11-01-0358**

Vickers Easidriver 14 Cm / 5 1/2"



**11-01-0359**

14 cm / 5 1/2"  
Handle W/ Chuck Longitudinally  
Bored Accommodating up to 3,95mm



**11-01-0360**

Handle with chuck T-Shaped



**11-01-0361**

Fiber T-Handle Key



**11-01-0362**

Key



**11-01-0363**

Key



# AllWell Instruments co.

The name of Health Cure Instruments

ORTHOPEDIC DRILL BITS - BURS - TREPHINES



**11-00-01**

5mm Borchardt Shaft Twist Drill, Long Working End

A: 2.0mm B: 2.5mm C: 3.0mm D: 3.2mm E: 3.5mm F: 4.0mm G: 5.0mm H: 6.0mm I: 7.0mm



**11-00-02**

5mm Borchardt Shaft Twist Drill

A: 1.0mm B: 1.5mm C: 1.8mm D: 2.0mm E: 2.2mm F: 2.5mm G: 2.8mm H: 3.0mm I: 3.2mm J: 3.5mm K: 4.0mm L: 5.0mm



**11-00-03**

5mm Borchardt Shaft Flat Trepine

A: 1.8mm B: 2.0mm C: 2.2mm D: 2.5mm E: 3.0mm F: 3.5mm G: 4.0mm H: 5.0mm



**11-00-04**

5mm Borchardt Shaft Spherical Burr

A: 3.0mm B: 4.0mm



**11-00-05**

5mm Borchardt Shaft Spherical Burr

A: 3.0mm B: 5.0mm

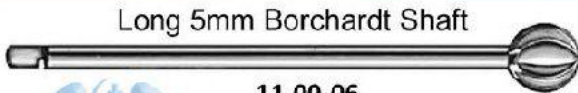

**11-00-06**

Doyen Spherical Burr

A: 4mm B: 6mm C: 8mm D: 10mm E: 12mm F: 14mm G: 16mm

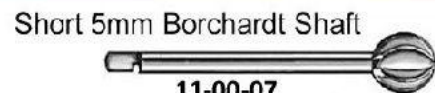

**11-00-07**

Doyen Spherical Burr

A: 4mm B: 6mm C: 8mm D: 10mm E: 12mm F: 14mm G: 16mm

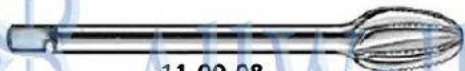

**11-00-08**

Doyen Conical Burr

Coarse Spacing 12mm Dia

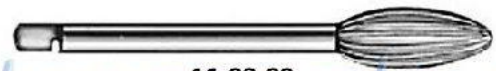

**11-00-09**

Doyen Conical Burr

Fine Spacing A: 8mm / B: 10 mm

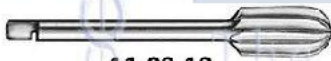

**11-00-10**

Doyen Cylindrical Burr

Coarse Spacing A: 12mm / B: 15mm



**11-00-11**

Albee Burr Oval Coarse Spacing

A: 8mm / B: 10 mm / C: 12 mm



**11-00-12**

Albee Burr Pointed 7 mm



**11-00-13**

Borchardt Burr Oval Coarse Spacing 13mm



**11-00-14**

Flat Burr Short Borchardt Shaft 25mm



**11-00-15**

Toti Trepine Short Borchardt Shaft 8mm





# AllWell Instruments co.

The name of Health Cure Instruments

BONE HOLDING CLAMPS - TRACTION BAR



11-01-0364 Gerster-Lowman Bone Holding Clamp



Standard Clamp

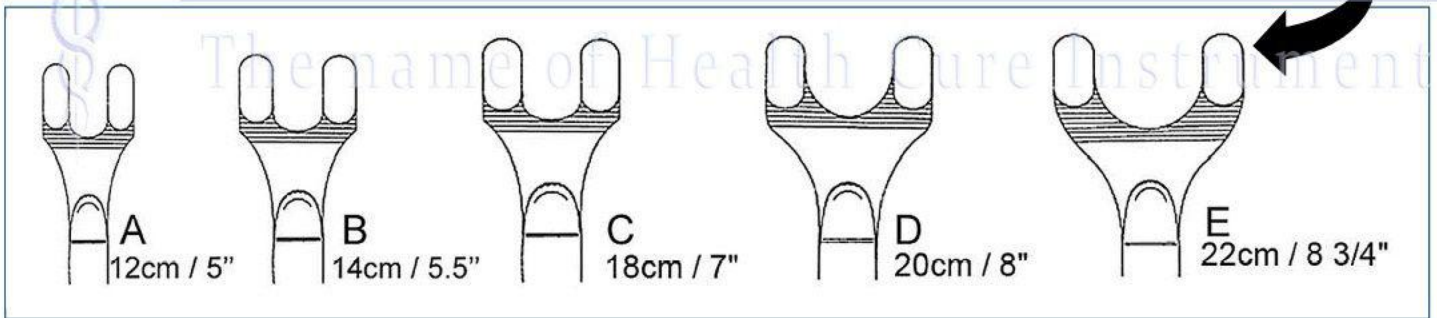

Angled Clamp

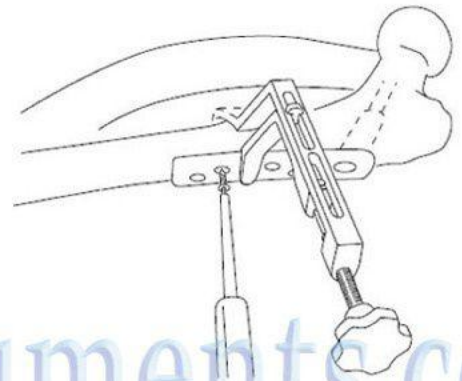

1X2 Jaws

11-01-0365 Gerster-Lowman Bone Holding Clamp

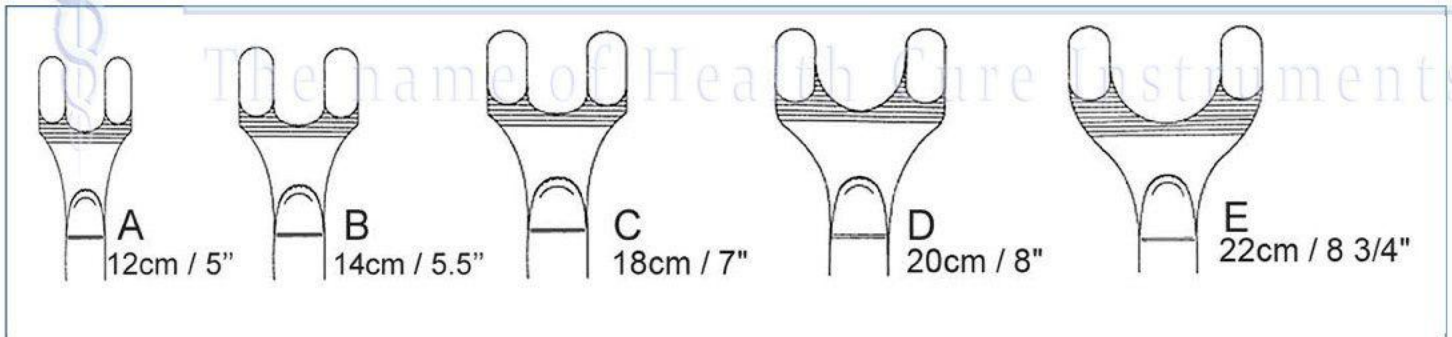



# AllWell Instruments co.

The name of Health Cure Instruments

BONE HOLDING CLAMPS - TRACTION BAR



**11-01-0366** Gerster Traction bar 15 cm / 6"

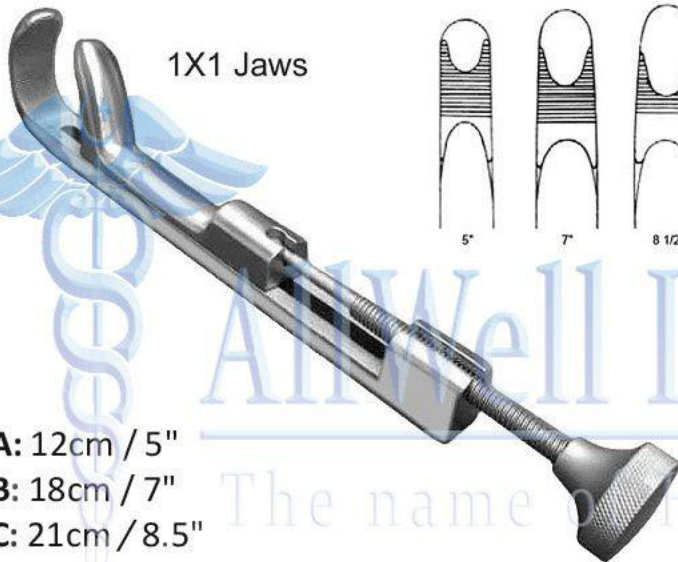

1X1 Jaws

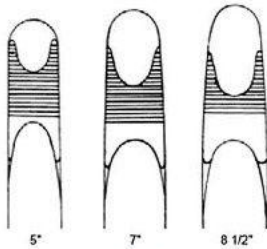

5"

7"

8 1/2"

- A: 12cm / 5"
- B: 18cm / 7"
- C: 21cm / 8.5"

**11-01-0367**

Gerster-Lowman Bone Holding Clamp



2X2 Jaws

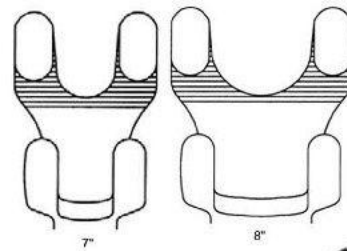

7"

8"

- A: 18cm / 7"
- B: 20cm / 8"

**11-01-0368**

Gerster-Lowman Bone Holding Clamp





# AllWell Instruments co.

The name of Health Cure Instruments

WISE GRIPS - NOSE PLIERS - SLAP HAMMERS [ALL MADE OF STAINLESS STEEL]



**11-01-0369**  
Vise Grip Locking Plier 23 cm / 9"



**11-01-0372**  
Needle Nose Locking Plier 30 cm / 12"



**11-01-0370**  
Vise Grip Locking Plier 20.5 cm / 8"



**11-01-0373**  
Needle Nose Locking Plier 25.5 cm / 10"



**11-01-0371**  
Vise Grip Locking Plier 18 cm / 7"



**11-01-0374**  
Needle Nose Locking Plier 22 cm / 8.5"

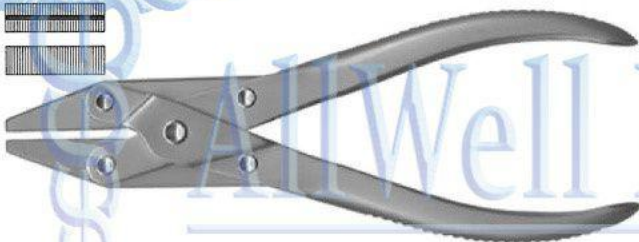

**11-01-0375**  
Flat Nose Plier 18.5 cm / 7 1/4" Parallel Grip SS



**11-01-0377**  
Long Nose Plier 22 cm / 8 1/4"

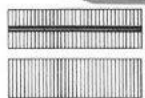

Max 1.6mm Cutting Capacity

**11-01-0376**  
Flat Nose Plier-Cutter 18.5 cm / 7 1/4" Parallel Grip SS



**11-01-0378**  
Vise Grip 20.5 cm / 8" Stainless Steel





# AllWell Instruments co.

The name of Health Cure Instruments

WISE GRIPS - NOSE PLIERS - SLAP HAMMERS [ALL MADE OF STAINLESS STEEL]



**11-01-0379**

Regular Jaw Locking Plier

A: 18 cm / 7" B: 20 cm / 8" C: 23 cm / 9"



**11-01-0380**

Needle Nose Locking Plier

A: 22 cm / 8.5" B: 25.5 cm / 10" C: 30 cm / 12"



**11-01-0381**

SLAP HAMMER w/ Threaded Shaft Head



**11-01-0382**

SLAP HAMMER w/ Hexa Shaft Head



**11-01-0383**

Combi-Fiat Nose Pliers 15 cm / 6"  
For Bending & Cutting

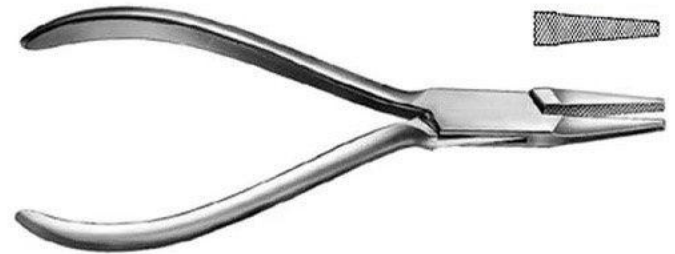

**11-01-0385**

Flat Nose Plier 13.5 cm / 5 1/4"



**11-01-0384**

Round / Flat Nose Pliers 18 cm / 7"



**11-01-0386**

Hackstock Flat Nose Pliers 16 cm / 6 1/4"





# AllWell Instruments co.

The name of Health Cure Instruments

NOSE PLIERS - PULLING FORCEPS - WIRE CUTTERS

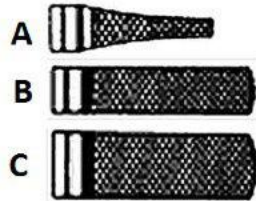

**11-01-0387**

Flat Nose Pliers 18 cm / 7" Parallel Grip



**11-01-0388**

Flat Nose Pliers 17 cm / 6 3/4" with crosswise groove



**11-01-0389**

Flat Nose Pliers 17.5 cm / 7"



**11-01-0390**

Flat Nose Pliers Pointed 19.5 cm / 7 3/4"



**11-01-0391**

Platypus Nail Pulling Forceps 15.5 cm / 6 1/4"

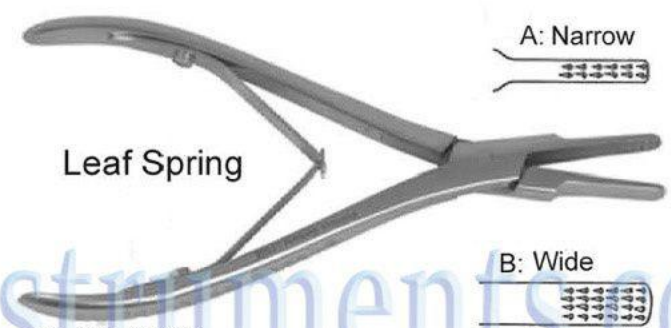

**11-01-0392**

Platypus Nail Pulling Forceps 15.5 cm / 6 1/4"



For  
Cerclage Wire

**11-01-0393**

Round Nose Pliers 15.5 cm / 6 1/4"



**11-01-0394**

Needle Nose Pliers 15.5 cm / 6 1/4"





# AllWell Instruments co.

The name of Health Cure Instruments

NOSE PLIERS - PULLING FORCEPS - WIRE CUTTERS

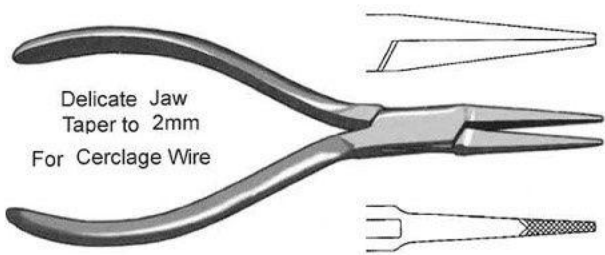

Delicate Jaw  
Taper to 2mm  
For Cerclage Wire

**11-01-0395**

Flat Nose Pliers 15 cm / 6"

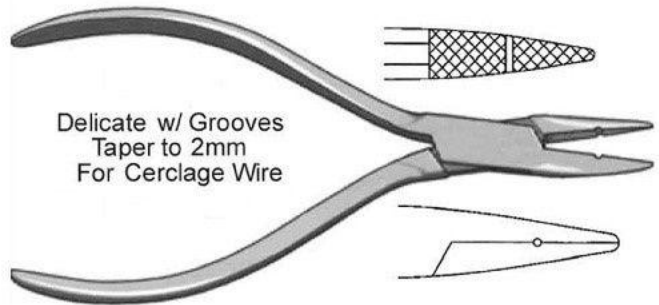

Delicate w/ Grooves  
Taper to 2mm  
For Cerclage Wire

**11-01-0396**

Needle Nose Pliers 13.5 cm / 5 1/4"

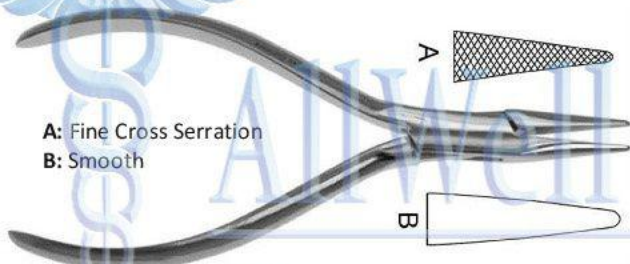

A: Fine Cross Serration  
B: Smooth

**11-01-0397**

Needle Nose Pliers Taper to 2mm Tip 14 cm / 5 1/2"



Soft wires up to 2.4mm  
Hard wires up to 1.8mm

**11-01-0398**

Wire Cutting Pliers 18.5 cm / 7 1/4"



**11-01-0399**

Martin "Diamant" 16cm / 6 1/4"



Delicate w/ Grooves  
Taper to 2mm  
For Cerclage Wire

**11-01-0400**

Circlage Pliers / Cutter 14 cm / 5 1/2"

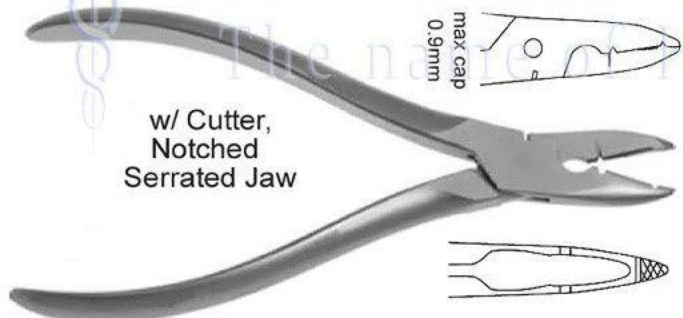

w/ Cutter,  
Notched  
Serrated Jaw

**11-01-0401**

Wire Bending Pliers 20 cm / 8"

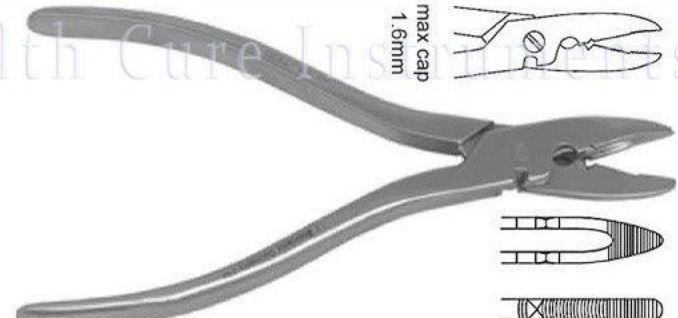

max cap  
1.6mm

**11-01-0402**

Wire Bending Pliers 15 cm / 6"





# AllWell Instruments co.

The name of Health Cure Instruments

NOSE PLIERS - PULLING FORCEPS - WIRE CUTTERS

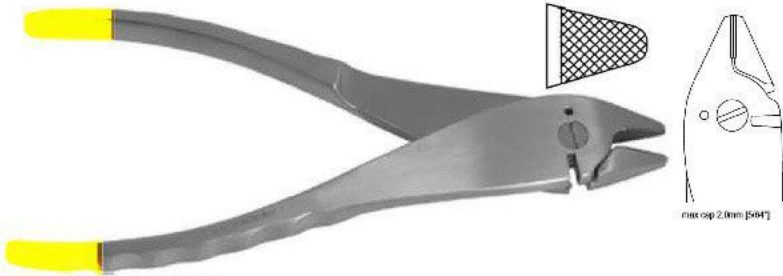

**11-01-0403**

Wire Bending Pliers TC 20 cm / 8"

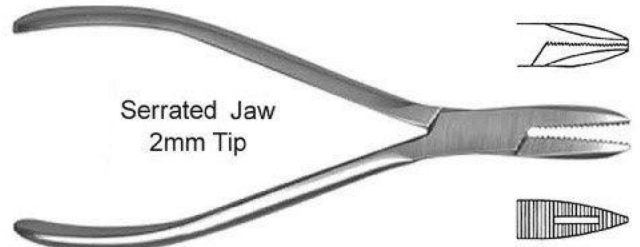

Serrated Jaw  
2mm Tip

**11-01-0404**

Needle Nose Pliers 15 cm / 6"

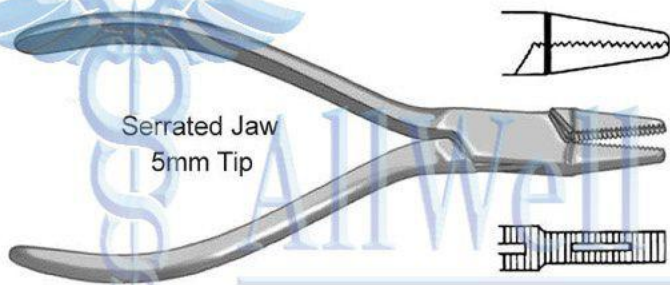

Serrated Jaw  
5mm Tip

**11-01-0405**

Flat Nose Pliers 14 cm / 5 1/2"

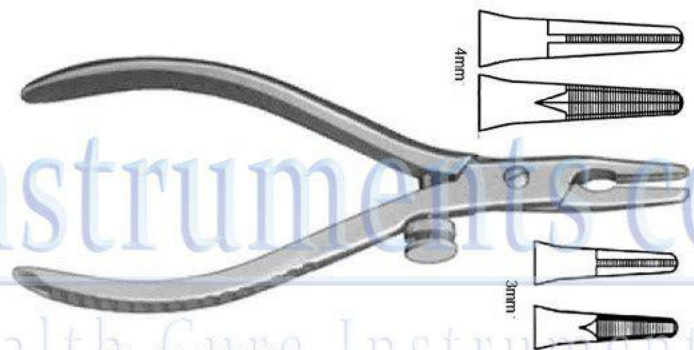

**11-01-0406**

K-Wire Pliers A: 13 cm / 5" B: 17.5 cm / 7"

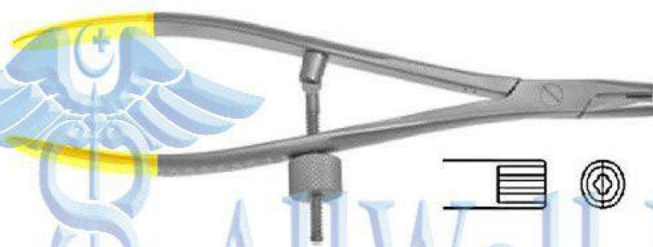

**11-01-0407**

Screw/Pin Removing Pliers 19 cm / 7 1/2"



Tip Taper  
to  
3mm

**11-01-0408**

Pin Puller Grips Small Pins 14 cm / 5 1/2"

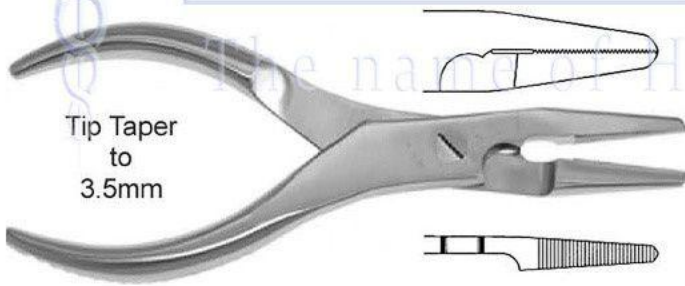

Tip Taper  
to  
3.5mm

**11-01-0409**

Flat Nose Pliers w/ Cutter for Cerclage Wire 16 cm / 6 1/2"



Tip Taper  
to  
3.5mm

**11-01-0410**

19 cm / 7 1/2" Narrow Nose Pliers Heavy Jaws  
for Pulling Wire / Pins





# AllWell Instruments co.

The name of Health Cure Instruments

PLIERS - BENDERS - ROD INSTRUMENTS

- A: 17.5 cm / 7" Needle Nose 2" Jaw
- B: 16 cm / 6 1/2" Square 7mm Jaw
- C: 18 cm / 7" Tape to 2mm Tip

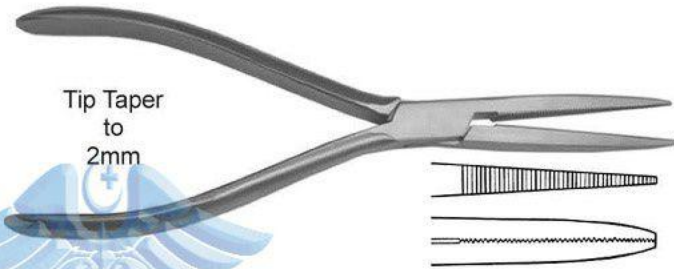
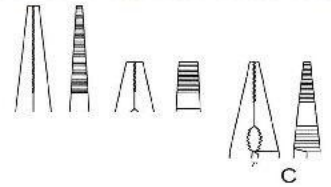

Tip Taper to 2mm

**11-01-0411**

Long Jaw Pliers 2inch Long Jaw Delicate 17.5 cm / 7"



**11-01-0412**

UNIVERSAL Pliers

Serrated w/ Heavy duty Spring and Cutting Edge  
Max Cutting Cap: 1.1 mm

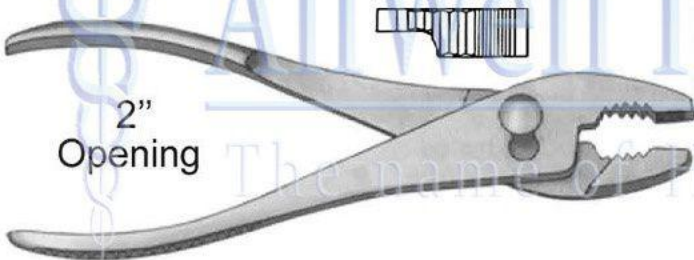

2" Opening

**11-01-0413**

Slip Joint Pliers 20 cm / 8"

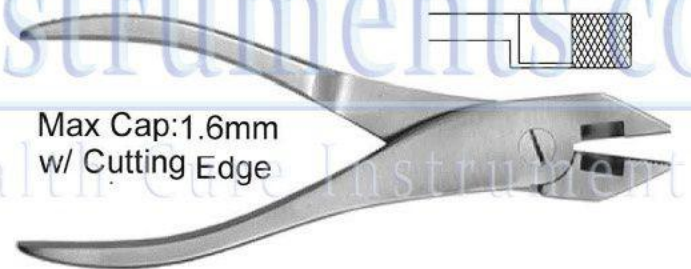

Max Cap: 1.6mm w/ Cutting Edge

**11-01-0414**

Lineman Pliers 21 cm / 8 1/2"

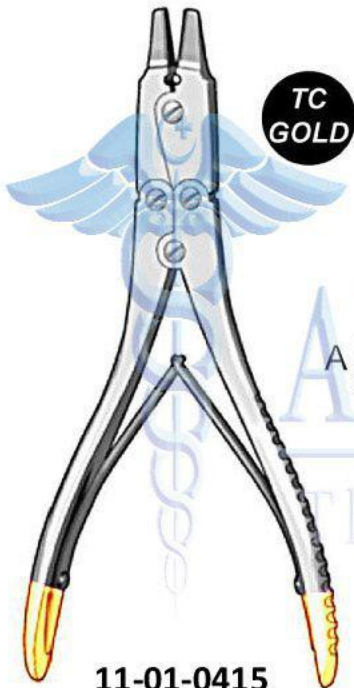

TC GOLD

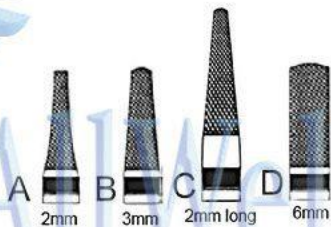

- A: 2mm Delicate Jaw TC
- B: 3mm Jaw TC
- C: 2mm Long Jaw TC
- D: 6mm Jaw TC

**11-01-0415**

Double Action Wire Extraction Plier  
18 cm / 7"

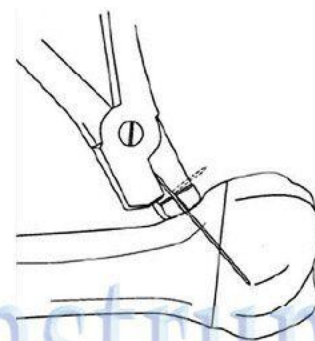

**11-01-0416**

Gratloch Wire Bender  
19 cm / 7 1/2"



Max Cap: 1.6mm





# AllWell Instruments co.

The name of Health Cure Instruments

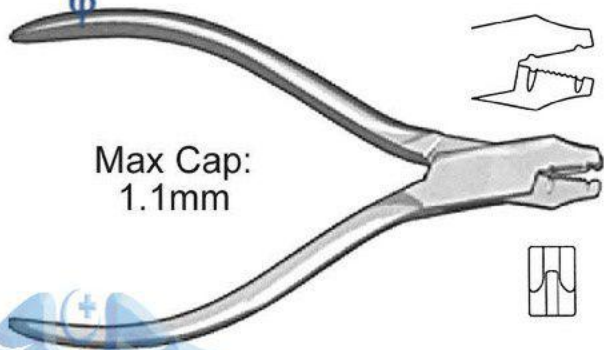

Max Cap:  
1.1mm

**11-01-0417**

K-Wire / Plate Bender 13.5cm / 5"

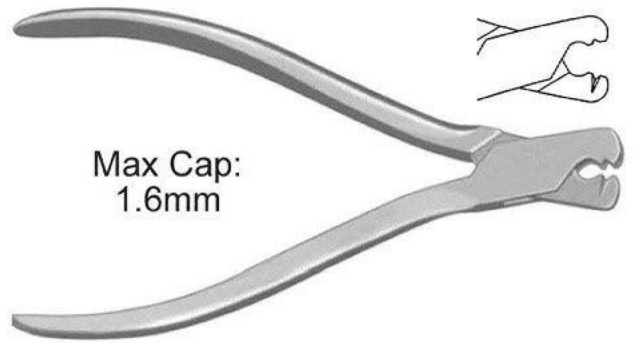

Max Cap:  
1.6mm

**11-01-0418**

K-Wire / Plate Bender 14.5 cm / 5 1/2"

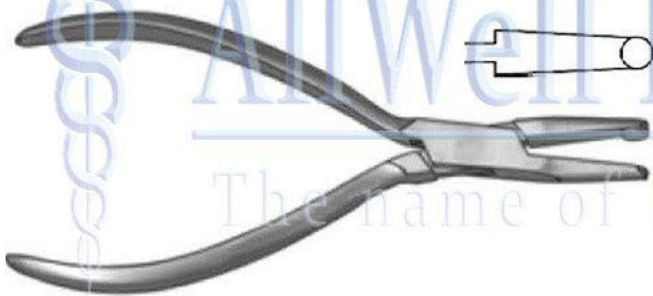

**11-01-0419**

Mini Plate Bending Pliers 13.5 cm / 5"

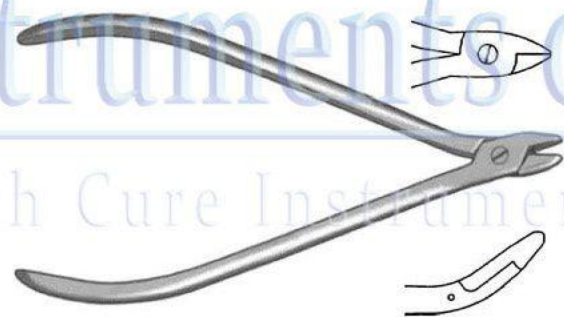

**11-01-0420**

Plate Bending Pliers 14.5 cm / 5 1/2"

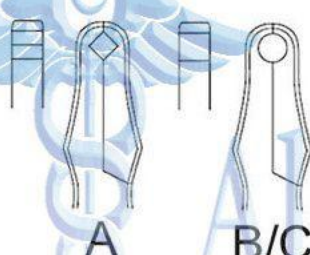

- A: 5.5mm Rods Prism
- B: 5.5mm Rods
- C: 6.35mm Rods



**11-01-0421**

Rod Holder STR 25 cm / 10"

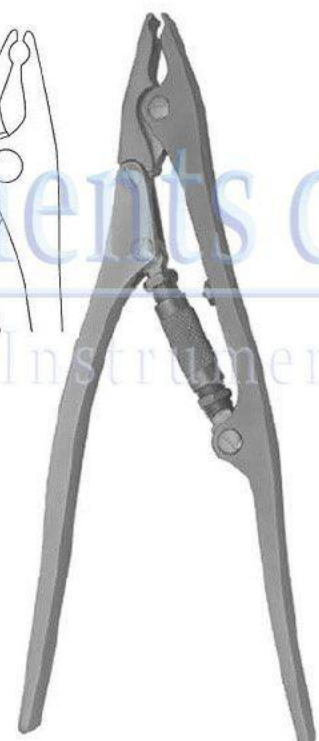

**11-01-0422**

Rod Gripper Adjustable  
21 cm / 8 1/2"



# AllWell Instruments co.

The name of Health Cure Instruments

WIRE INSTRUMENTS - EXTENSION BOWS

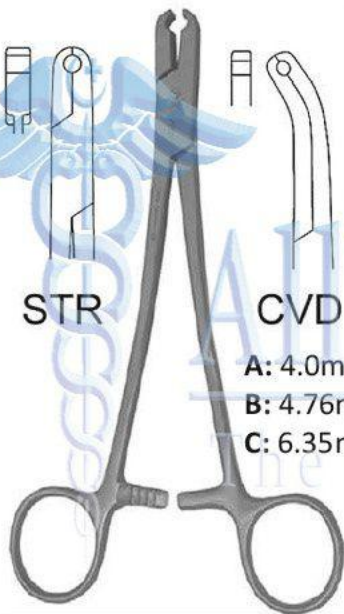

STR

CVD

- A: 4.0mm Rod
- B: 4.76mm Rod
- C: 6.35mm Rod

**11-01-0423**

Rod Holder 18 cm / 7 1/4"

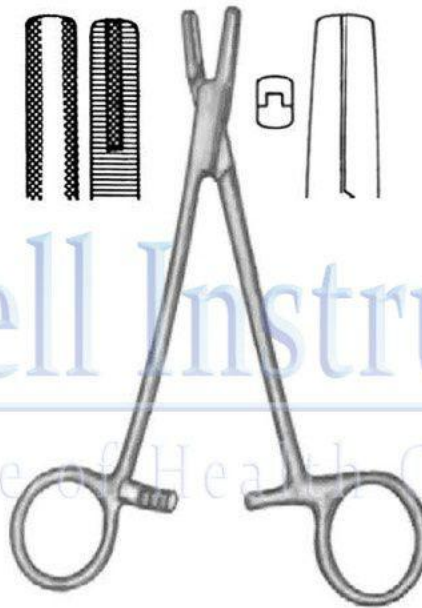

**11-01-0424**

Wire Pulling Forceps 16 cm / 6 1/2"

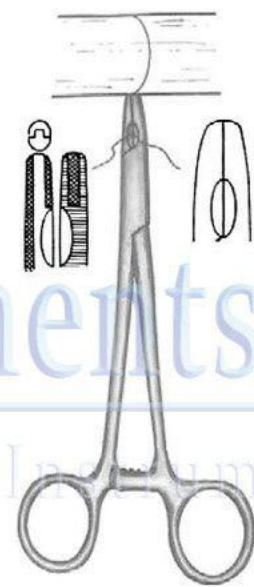

**11-01-0425**

Wire Twister / Tightner 16cm / 6 1/4"



**11-01-0426**

Loute Wire Tightener 21 cm / 8 1/4"



**11-01-0427**

Wire Tightener 12 cm / 4 3/4"



**11-01-0428**

Wire Tightener w / T Handle  
11.5 cm / 4 1/2"





# AllWell Instruments co.

The name of Health Cure Instruments

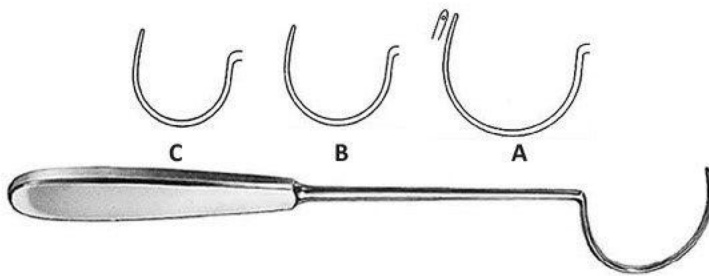

A: 31 cm / 12 1/4"  
B: 29 cm / 11 1/2"  
C: 28 cm / 11"

**11-01-0429**  
Demel Wire Guide

CVD Crochet Hook  
18cm / 7 1/4"



**11-01-0430**  
Bankert Ligature Carrier

CVD  
Crochet Hook Fiber handle  
A: 18cm / 7" B: 23cm / 9"

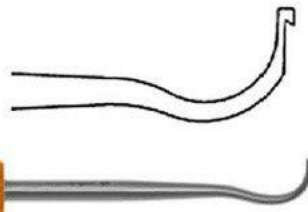

**11-01-0431**  
Suture Passer

CVD  
Suture Hole Fiber Handle  
A: 18cm / 7" B: 23cm / 9"

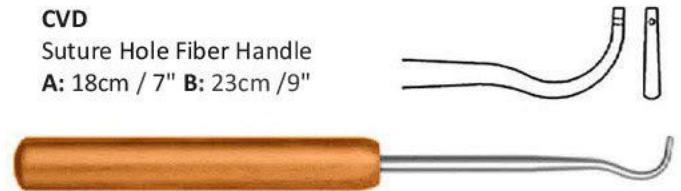

**11-01-0432**  
Suture Passer



Suture Hole  
20cm / 8"  
A: Right Blunt  
B: Left Blunt  
C: Right Sharp  
D: Left Sharp

**11-01-0433**  
Deschamps Ligature Carrier

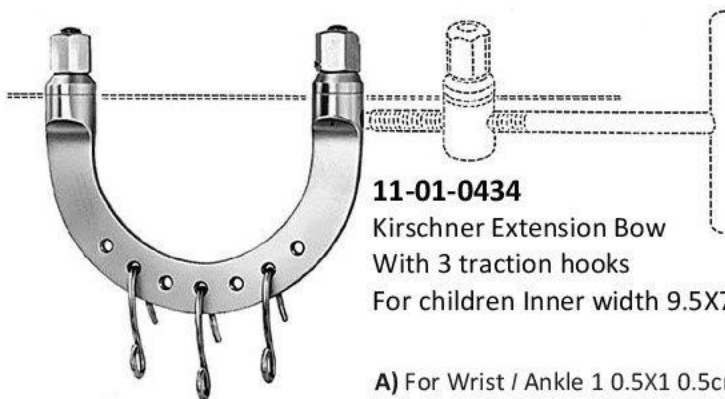

**11-01-0434**  
Kirschner Extension Bow  
With 3 traction hooks  
For children Inner width 9.5X7cm

- A) For Wrist / Ankle 1.05X1.05cm
- B) For Elbow 12X12cm
- C) For Knee 15.5X15.5cm
- D) For Femur 20X15.5cm

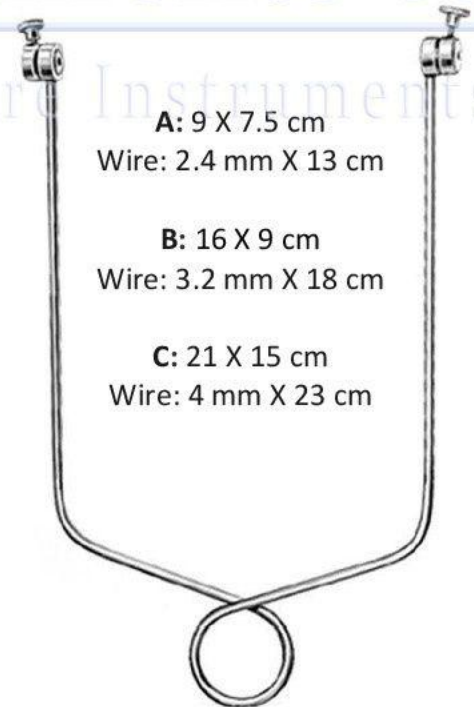

**11-01-0435**  
Bohler Extension Bow for femur & knee



# AllWell Instruments co.

The name of Health Cure Instruments

WIRE INSTRUMENTS - EXTENSION BOWS

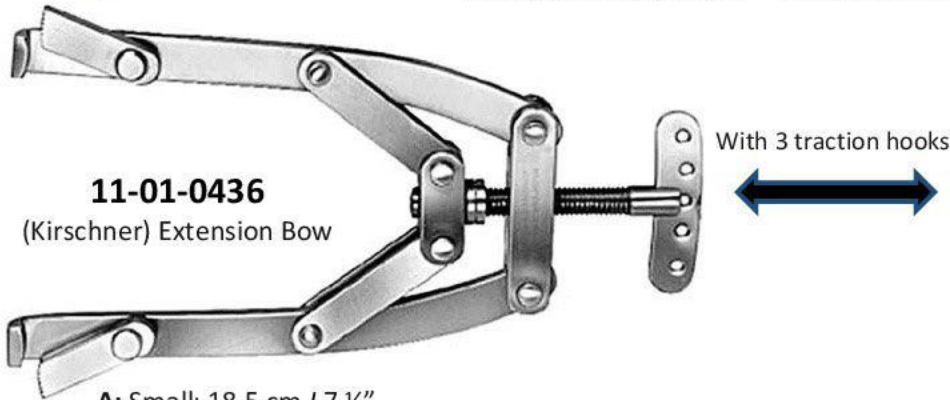

**11-01-0436**  
(Kirschner) Extension Bow

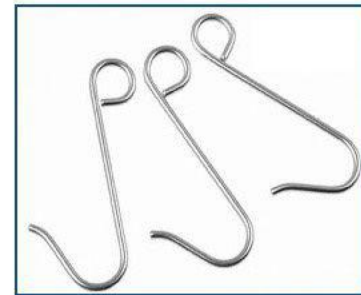

**Traction Hook  
For Extension Bows**

A: Small: 18.5 cm / 7 1/4"  
B: Large: 26.5 cm / 10 1/2"



**11-01-0437**  
Extension Bow  
A: 10 1/2" X 6 1/4"  
B: 7" X 4"



**11-01-0438**  
Wire Strainer 18.5 cm / 7 1/4"



**11-01-0439**  
Wrench 20 cm / 8"

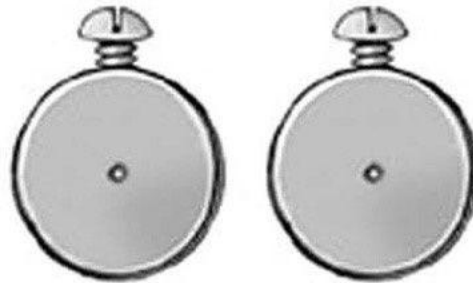

**11-01-0440**  
Fixation Discs  
For wire drills, pair

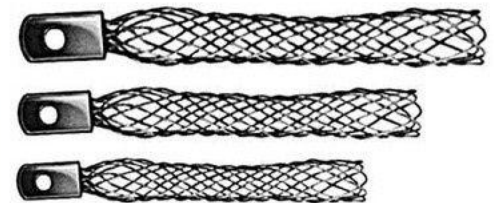

**11-01-0441**  
Extension Sleeve  
Small / Medium / Large





# AllWell Instruments co.

The name of Health Cure Instruments

RING CUTTERS – LEAD HANDS – BIOPSY TOOLS



**Complete with Drills**  
(Set of 3 drills) Small / Medium / Large

**11-01-0442**  
Martin-Ideal  
Finger Nail Drill



**11-01-0443**  
Feldheim Tourniquet 10 cm / 4"



**11-01-0444**  
Radolf Nail Extracting Forceps  
14 cm / 5 1/2"

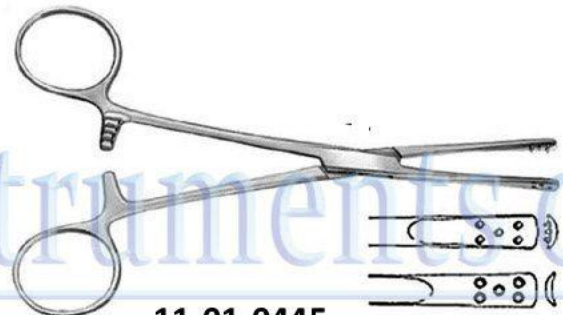

**11-01-0445**  
Nail Extracting Forceps 16 cm / 6 1/4"



**11-01-0446**  
Martin Finger Ring Saw 18.5 cm / 6 3/4"  
Spare Blades are Available Separately



**11-01-0447**  
Walton Finger Ring Saw 16cm / 6 1/4"  
Spare Blades are Available Separately

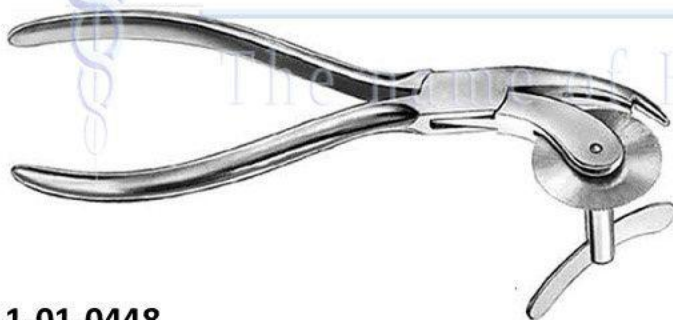

**11-01-0448**  
Finger Ring Saw 17cm / 6 3/4"  
Spare Blades are Available Separately



Stainless Steel  
Black Color



Stainless Steel  
Color

**11-01-0449**  
Finger Ring Saw Cutter Spare



# AllWell Instruments co.

The name of Health Cure Instruments

RING CUTTERS - LEAD HANDS - BIOPSY TOOLS



**11-01-0450**

Lead Hand for Kids / Adults



**11-01-0451**

Lead Hand for Kids / Adults



Outer Dia: 5mm  
Inner Dia: 3mm

**11-01-0452**

Champy-OSU Bone Biopsy Instruments  
22 cm / 8 3/4"

Consisting of trocar, a toothed trephine and a plunger for taking tibial and iliac bone grafts through a closed technique



**11-01-0453**

Champy Bone Biopsy Instruments  
22 cm / 8 3/4"

- A) Outer Dia: 5mm / Inner Dia: 4mm
- B) Outer Dia: 8mm / Inner Dia: 7mm





# AllWell Instruments co.

The name of Health Cure Instruments

BONE TAMPERS - IMPACTORS - PACKERS



**11-01-0454**

Bone Tamper  
15.5 cm / 6" Tip  
Sizes: 2-3-4-5-6-8-9-10 mm



A: 2 mm B: 3 mm C: 4 mm D: 5 mm  
E: 6 mm F: 8 mm G: 9 mm H: 10 mm



**11-01-0455**

Champy Cancellous Bone graft Mill

Outer Dia: 17mm  
Inner Dia: 16mm

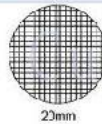

**11-01-0456**

Bone Impactor / Teflon Tip 17cm / 6 1/2"



**11-01-0457**

Caspar Bone Tamper 20 cm / 8"



10x4.3mm  
Micro Offset

10x4.3mm  
Micro Lateral

15x6.5mm  
Angled



**11-01-0458**

Lumbar / Cervical Impactor 21cm / 8 1/2"

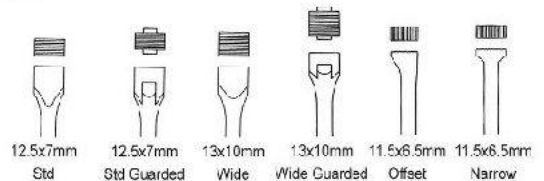

12.5x7mm  
Std

12.5x7mm  
Std Guarded

13x10mm  
Wide

13x10mm  
Wide Guarded

11.5x6.5mm  
Offset

11.5x6.5mm  
Narrow

**11-01-0459**

Lumbar / Cervical Impactor 21cm / 8 1/2"



# AllWell Instruments co.

The name of Health Cure Instruments

BONE RASPS - FILES



**11-01-0460**  
Bone Chip Packer 25cm / 10"

A: 2.X9mm B: 3X16mm  
C: 6X9mm D: 6X19mm  
E: 6mm Dia

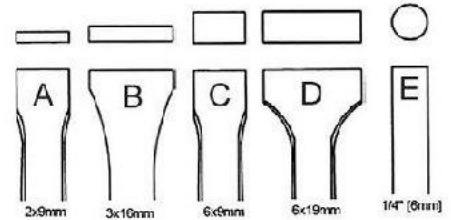

**11-01-0461**  
Bone Tamper 43 cm / 17"

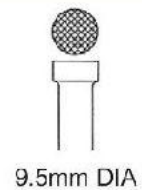

9.5mm DIA



**11-01-0462**  
Putti Bone Rasp Round / Semi Round  
30 cm / 11 3/4"



**11-01-0463**  
Putti Bone Rasp Curved / Straight  
27cm / 10 1/2"



**11-01-0464**  
Bone File 28 cm / 11" w/ Hollow Handle Semi Round



**11-01-0465**  
Bone File 24.5 cm / 9 3/4" w/ Hollow Handle Semi



**11-01-0466**  
Bone File 22 cm / 8 3/4" Flat / Round



**11-01-0467**  
Bone Rasp 22 cm / 8 3/4" Flat / Round



**11-01-0468**  
Bone File Fiber Handle 18cm / 7"

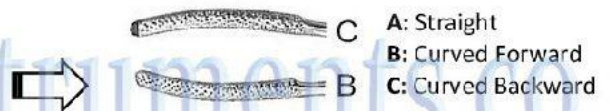

A: Straight  
B: Curved Forward  
C: Curved Backward



**11-01-0469**  
Bone File 18 cm / 7" Fiber Handle / Cross-Hatch



**11-01-0470**  
Bone File 18 cm / 7" Fiber Handle / Linear





# AllWell Instruments co.

The name of Health Cure Instruments

BONE RASPS - FILES



**11-01-0471A**

Bone File 18 cm / 7" Fiber Handle / STR Diamond Coated



**11-01-0471B**

Bone File 18 cm / 7" Fiber Handle / CVD Diamond Coated



# AllWell Instruments co.

The name of Health Cure Instruments



**11-01-0472A**

Bipolar Bone Rasp w / Rod



**11-01-0472B**

Femoral Bone Rasp w / Rod

A: Small B: Medium C: Large





# AllWell Instruments co.

The name of Health Cure Instruments

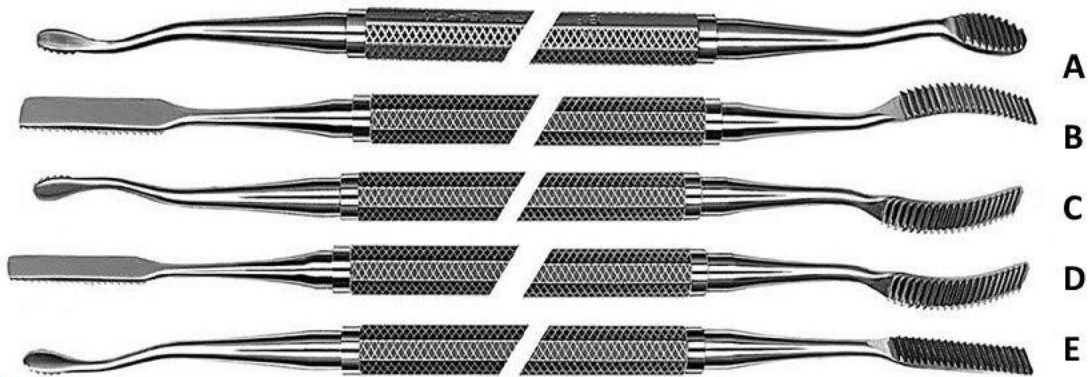

**11-01-0473**

Miller-Colburn Bone File 18 cm / 7" Downwards Cut

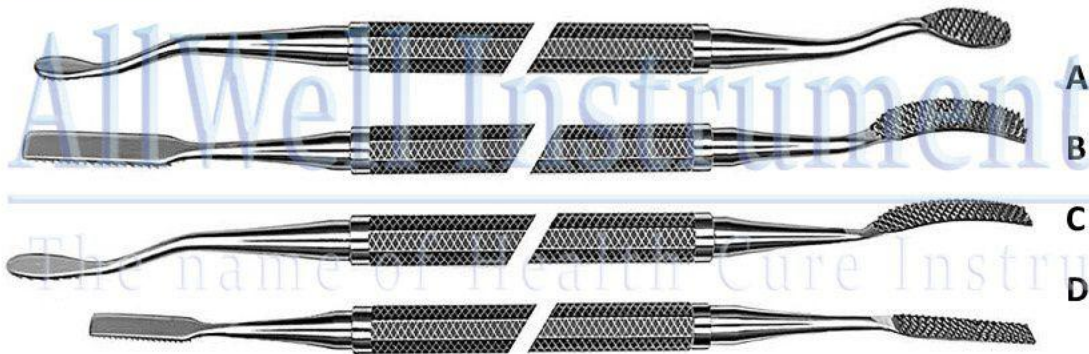

**11-01-0474**

Miller-Colburn Bone File 18 cm / 7" Cross Cut

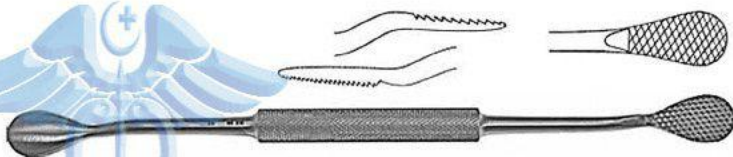

**11-01-0475**

Bone Rasp 21 cm / 8.5" 13mm Fine/Coarse Straight

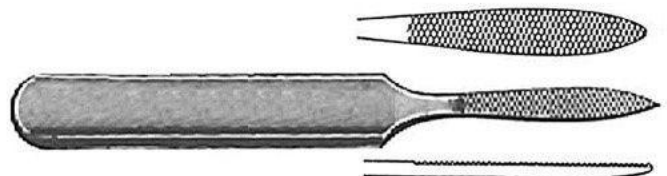

**11-01-0476**

Bone Rasp Joseph 16 cm / 6.25" 8mm Fine Cross Serrated / Straight



**11-01-0477**

Bone Rasp Lewis 19 cm / 7.5" 8mm

Fine Serr  
Coarse Serr



**11-01-0478**

Bone Rasp Cottle 20 cm / 8" 7mm Plain Serrated Downward





# AllWell Instruments co.

The name of Health Cure Instruments

BONE RASPS - FILES

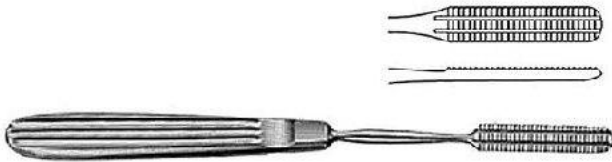

**11-01-0479**

Bone Rasp Maltz 18 cm / 7"  
9mm Plain Coarse Serr Downward

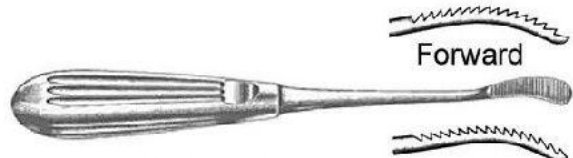

**11-01-0480**

Bone Rasp Aufriecht 18 cm / 7"  
9mm Coarse Serr CVD

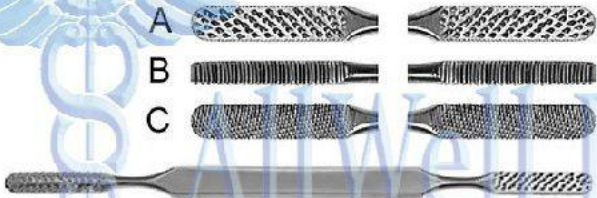

**11-01-0481**

Bone Rasp Fomon 21 cm / 8.5"  
8mmX40mm Course Serr 4 Sided Flat / Convex Baldes



**11-01-0482**

Bone Rasp Fomon 21 cm / 8.5"  
8mmX40mm Fine Serr 4 Sided Flat / Convex Blades

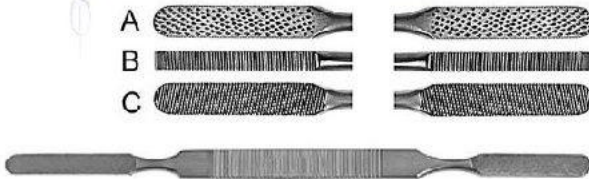

**11-01-0483**

Bone Rasp Kleinert Kurtz 21 cm / 8.5"  
8mmX45mm Fine/Coarse Serr 4 Sided Flat / Convex



**11-01-0484**

Bone File / Rasp 21 cm / 8.5"  
18mm Fine / Coarse Serr



# AllWell Instruments co.

The name of Health Cure Instruments

BONE LEVERS - RETRACTORS



**11-01-0485**  
Bone Lever 16 cm / 6 1/4"



**11-01-0486**  
Hohman, Mini Bone Lever 16 cm / 6 1/4" 6 mm tip



**11-01-0487**  
Hohman, Mini Bone Lever 16 cm / 6 1/4" 8 mm tip



**11-01-0488**  
Mini Bone Lever 16cm / 6 1/4" 14 mm tip

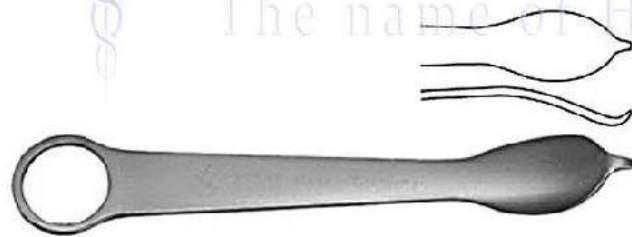

**11-01-0489**  
Hohman, Mini Bone Lever 12 cm / 4 3/4" 14 mm tip

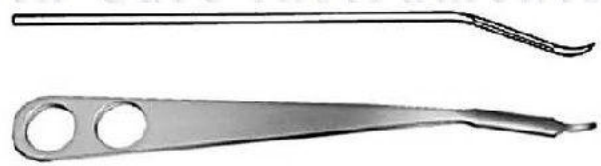

**11-01-0490**  
Hohmann Bone Lever 22 cm / 8 3/4" 8 mm Tip narrow tip

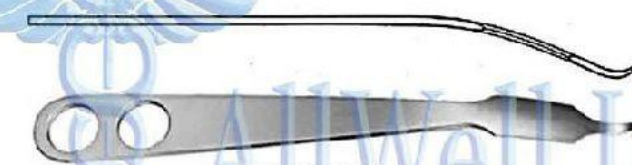

**11-01-0491**  
Hohmann Bone Lever 23.5 cm / 9 1/4" 18 mm Tip narrow tip

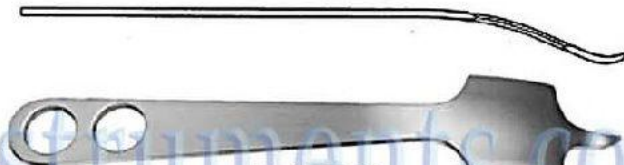

**11-01-0492**  
Hohmann Bone Lever 23.5 cm / 9 1/4" 43 mm Tip narrow tip



**11-01-0493**  
Hohmann Bone Lever 29 cm / 11 1/2" 35mm Tip wide tip



**11-01-0494**  
Lange-Hohmann Bone Lever 25 cm / 9 3/4" 22mm Tip  
Wide tip with groove





# AllWell Instruments co.

The name of Health Cure Instruments

BONE LEVERS - RETRACTORS

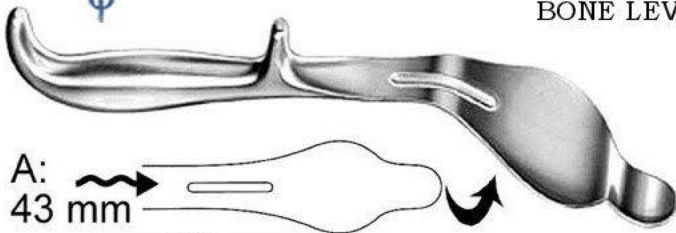

A: 43 mm

B: 60 mm

11-01-0495

Bennett Bone Lever 24 cm / 9 1/2"



11-01-0496

Hohmann Bone Lever 27.5 cm / 10 3/4"  
24mm Tip wide, round tip



11-01-0497

Hohmann Bone Lever 25 cm / 9 3/4" 70 mm Tip narrow tip



11-01-0498

Blount Knee Retractor 26.5 cm / 10 1/2" blunt

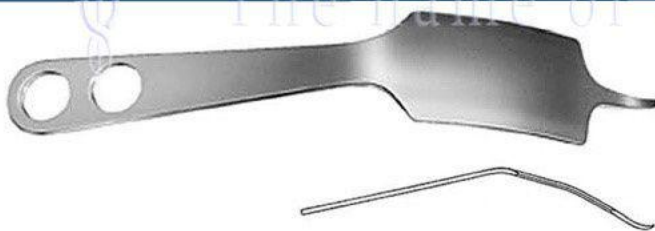

11-01-0499

Hohmann Bone Lever 23.5 cm / 9 1/4" 43mm Tip narrow tip



11-01-0500

Blount Knee Retractor 26.5 cm / 10 1/2"

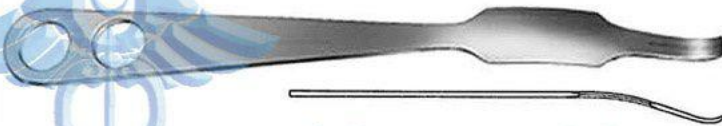

11-01-0501

Hohmann Bone Lever 25.5 cm / 10" 22mm Tip wide tip



11-01-0502

Blount Knee Retractor 17.5 cm / 7"

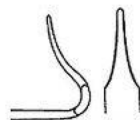

Sizes Available:

A: 75 X 30 mm

B: 100 X 30 mm

11-01-0503

Taylor Spinal Retractor

16 cm / 6 1/4"

Pointed end





# AllWell Instruments co.

The name of Health Cure Instruments

BONE LEVERS - RETRACTORS

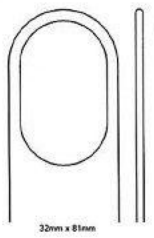

**11-01-0504**  
Fukuda Retractor  
19 cm / 7 1/2"  
T-Handle

A: 32X81mm  
B: 38X81mm

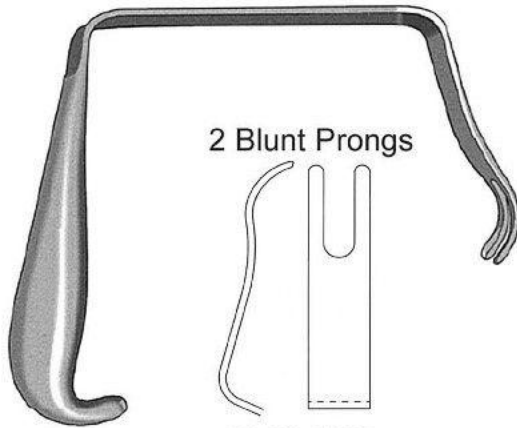

**11-01-0505**  
Bristow / Bankart Humeral Retractor  
18 cm / 7"



**11-01-0506**  
Z Knee Retractor 15 cm / 6"  
**Medium Blade:**  
57 / 69mm Deep  
11mm Wide  
**Large Blade:**  
63 / 76mm Deep  
11mm Wide



**11-01-0507**  
Deltoid Retractor 28 cm / 11" T Handle w / Ring



**11-01-0508**  
Humeral Head Retractor 18 cm / 7" Strong Curved  
2 Blunt Prongs

22 mm Blade  
1 Sharp Prong

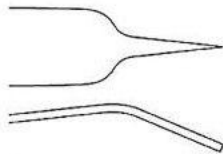

**11-01-0509**  
Capsule Retractor 25 cm / 10"



22 mm Blade  
2 Sharp Prong

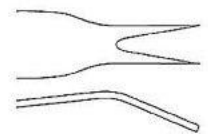

**11-01-0510**  
Capsule Retractor 25 cm / 10"



3 Sharp Prongs

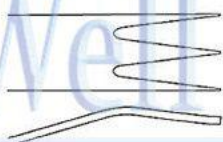

**11-01-0511**  
Capsule Retractor 25 cm / 10"



Soft Tissue Retractor  
3 Blunt Prong

22mm  
Blade

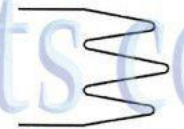

**11-01-0512**  
Bristow / Bankart 19 cm / 7 1/2"

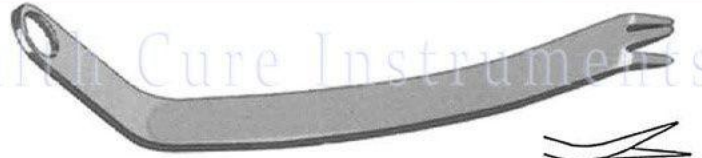





# AllWell Instruments co.

The name of Health Cure Instruments

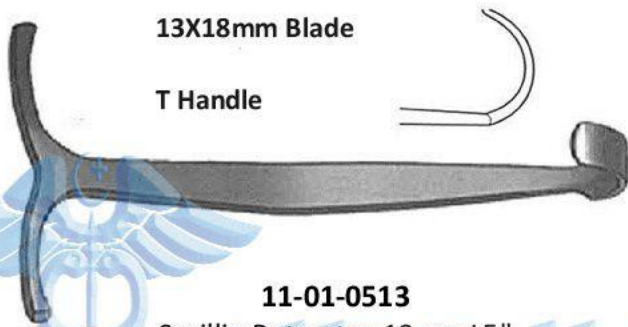

13X18mm Blade

T Handle

**11-01-0513**

Smillie Retractor 13 cm / 5"

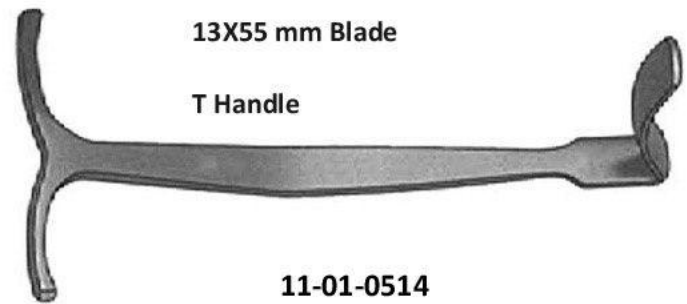

13X55 mm Blade

T Handle

**11-01-0514**

Smillie Retractor 14 cm / 5 1/2"



Small: 19X32mm  
Medium: 19X45mm  
Large: 19X60mm  
T Handle

**11-01-0515**

Smillie Retractor Angled Blade 14cm / 5 1/2"



9 X 38 mm Blade

**11-01-0516**

Knee Retractor 22 cm / 8 1/2" Ring Handle

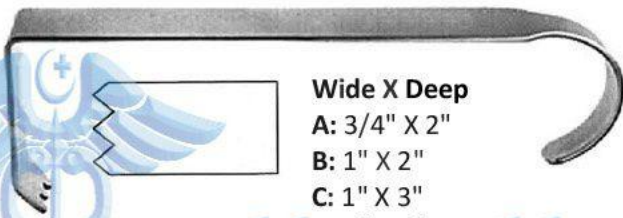

Wide X Deep

A: 3/4" X 2"

B: 1" X 2"

C: 1" X 3"

D: 1" X 4"

**11-01-0517**

Hibbs Retractor 24 cm / 9 1/2" Sharp Teeth

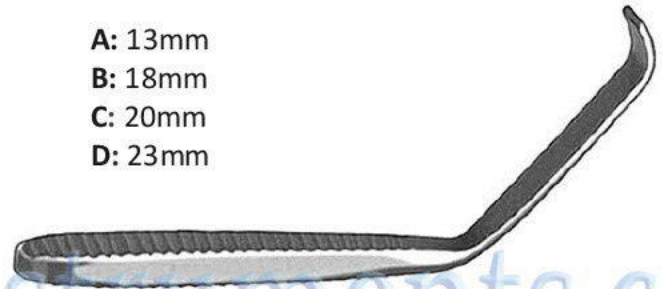

A: 13mm

B: 18mm

C: 20mm

D: 23mm

**11-01-0518**

Blade Retractor 19 cm / 7 1/2"

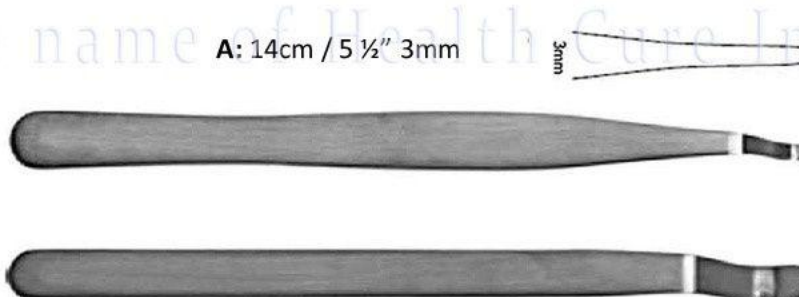

A: 14cm / 5 1/2" 3mm

3mm

B: 15cm / 6" 7mm

7mm

**11-01-0519** Hayes Retractor



# AllWell Instruments co.

The name of Health Cure Instruments

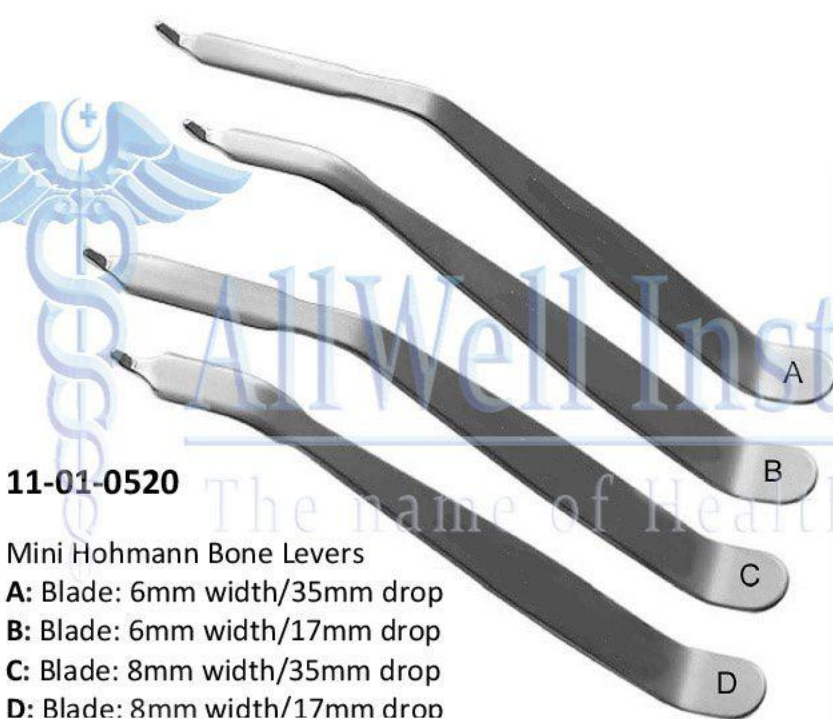

**11-01-0520**

Mini Hohmann Bone Levers

A: Blade: 6mm width/35mm drop

B: Blade: 6mm width/17mm drop

C: Blade: 8mm width/35mm drop

D: Blade: 8mm width/17mm drop

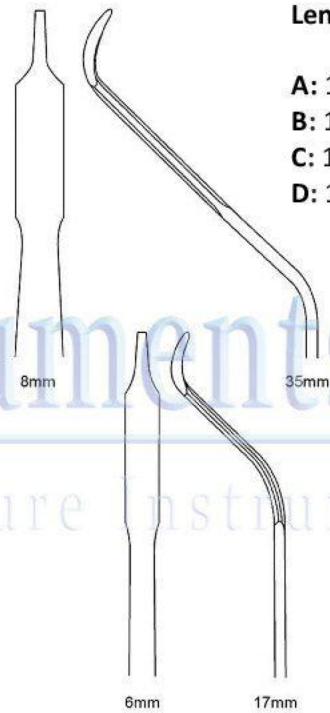

Length:

A: 15cm / 6"

B: 15.5cm / 6 1/4"

C: 15cm / 6"

D: 15.5cm / 6 1/4"

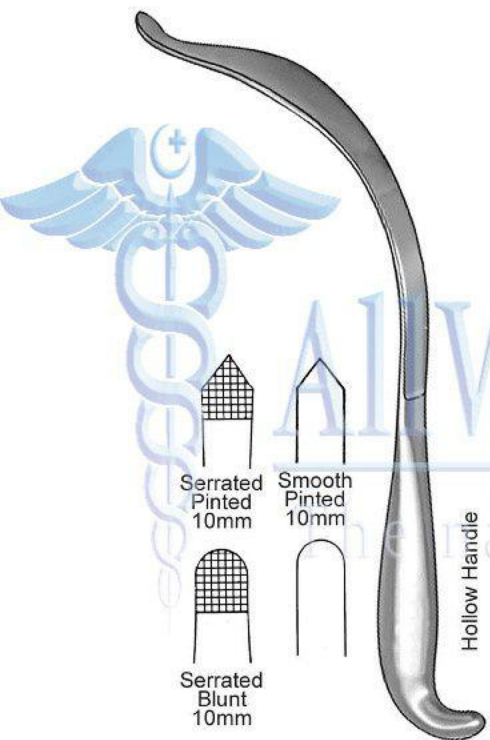

**11-01-0521**

Aufranc Cobra Retractor  
26 cm / 10 1/2"



**11-01-0522**

Aufranc Cobra Retractor  
27.5cm / 11"

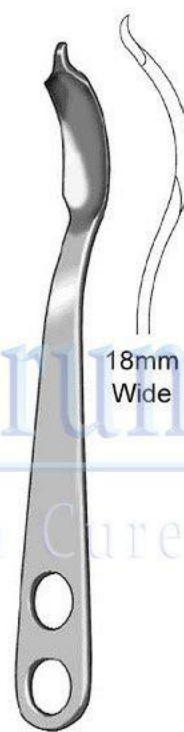

**11-01-0523**

Humeral Head Retractor  
23 cm / 9"

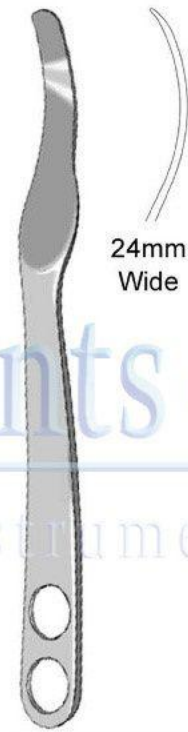

**11-01-0524**

Pelvic Retractor Single Prong  
26 cm / 10 1/2"





# AllWell Instruments co.

The name of Health Cure Instruments

## BONE LEVERS - RETRACTORS

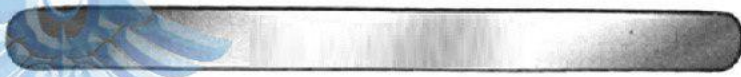

**11-01-0525**

Ribbon Retractor Malleable  
30 cm / 12"

### AVAILABLE SIZES:

- |                         |                      |                      |
|-------------------------|----------------------|----------------------|
| <b>A:</b> 6" X 6mm      | <b>G:</b> 8" X 10mm  | <b>M:</b> 13" X 38mm |
| <b>B:</b> 6" X 12mm     | <b>H:</b> 8" X 12mm  | <b>N:</b> 13" X 45mm |
| <b>C:</b> 6" X 16mm     | <b>I:</b> 8" X 16mm  | <b>O:</b> 13" X 50mm |
| <b>D:</b> 6" X 19mm     | <b>J:</b> 8" X 19mm  | <b>P:</b> 13" X 65mm |
| <b>E:</b> 7 1/2" X 25mm | <b>K:</b> 13" X 19mm | <b>Q:</b> 13" X 75mm |
| <b>F:</b> 8" X 6mm      | <b>L:</b> 13" X 30mm |                      |



**11-01-0526**

Murphy Bone Skid  
30 cm / 12"

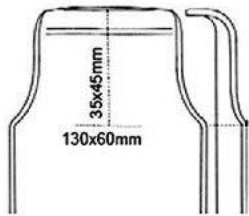

**A:** 29cm / 11 1/2" With Lip



**B:** 33cm / 13" With Lip

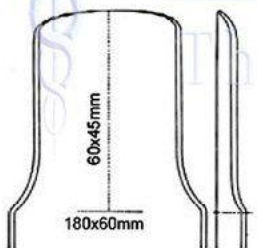

**C:** 33cm / 13" Without Lip



**11-01-0527**

St. Mark's Pelvic Retractor  
Angled Blade

- A:** 22mm Blade  
2 Finger Rings Long Round
- B:** 22mm Blade  
1 Finger Ring Short Round

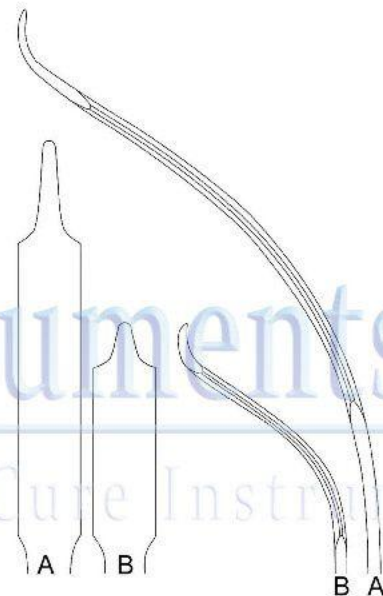
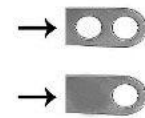

**11-01-0528**

Hohmann Retractor  
40cm / 16"





# AllWell Instruments co.

The name of Health Cure Instruments

## BONE LEVERS - RETRACTORS

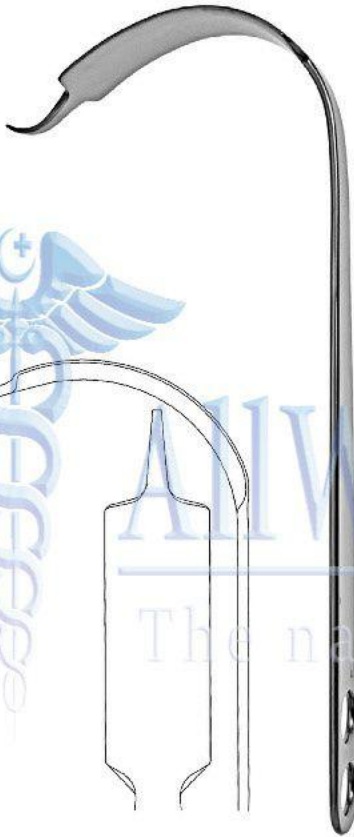

**11-01-0529**

Hohmann Retractor  
33 cm / 13"



**11-01-0530**

Virchow Skull Breaker  
7.5 cm / 3" 40 mm Blade Width

**11-01-0531**

Buckley Chisel  
16cm / 6 1/4"  
Octagonal handle

Fig A: 2mm

Fig B: 3mm

Fig C: 4mm

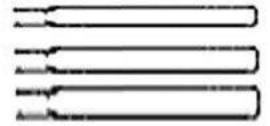

**11-01-0532**

Buckley Gouge  
16cm / 6 1/4"  
Octagonal handle

Fig A: 2mm

Fig B: 3mm

Fig C: 4mm

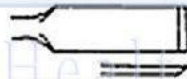
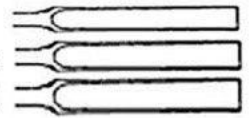

Fig C: 5mm

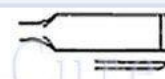

Fig B: 4mm

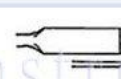
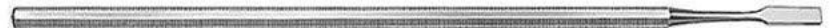

Fig A: 3mm



**11-01-0533**

Stout Bone Chisel 21 cm / 8 1/4" octagonal handle

**11-01-0534**

Bone Chisel 18 cm / 7" Round Handle

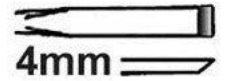

4mm



**11-01-0535**

Bone Chisel 17 cm / 6 3/4" Round Handle

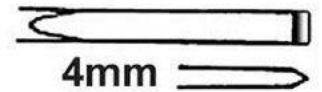

4mm

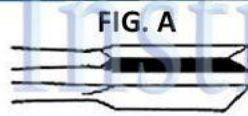

FIG. A

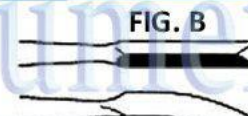

FIG. B



FIG. C



**11-01-0536**

Gardner Bone Chisel 17 cm / 6 3/4" 4 mm





# AllWell Instruments co.

The name of Health Cure Instruments

CHISELS - OSTEOTOMES - GOUGES

FIG A: 3 mm

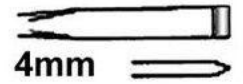

FIG B: 5 mm



**11-01-0537**

Snyder-O.S.U Bone Chisel 16.5 cm / 6 1/2" 3 mm / 5 mm



**11-01-0538**

Bone Chisel 18 cm / 7" Octagonal Handle 4 mm

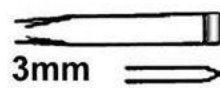

**11-01-0539**

Bone Chisel 18 cm / 7" Octagonal Handle 3 mm



FIG A

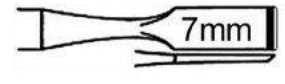
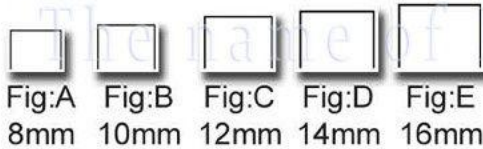

FIG B



**11-01-0540**

O.S.U. Bone Chisel 17 cm / 6 3/4" 7 mm / 9 mm



Side View



**11-01-0541**

Osteotome 13.5 cm / 5 1/4"

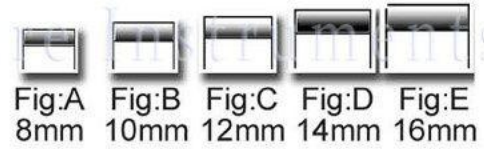

Side View



**11-01-0542**

Chisel 13.5 cm / 5 1/4"

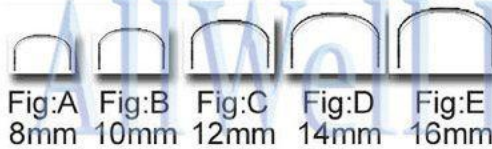

Side View



**11-01-0543**

Gouge 13.5 cm / 5 1/4"

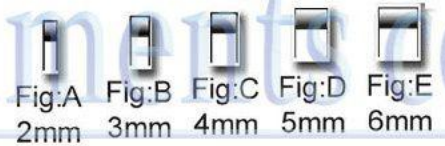

Side View



**11-01-0544** Partsch Chisel 13.5 cm / 5 1/4"

**11-01-0545** Partsch Chisel 17 cm / 6 3/4"



# AllWell Instruments co.

The name of Health Cure Instruments

CHISELS - OSTEOTOMES - GOUGES

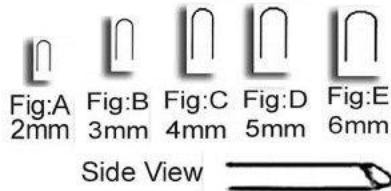

11-01-0546 Partsch Gouge 13.5 cm / 5 1/4"

11-01-0547 Partsch Gouge 13.5 cm / 5 1/4"

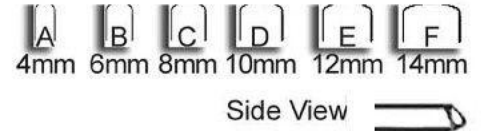

11-01-0548 Alexander Gouge 17.5 cm / 7"

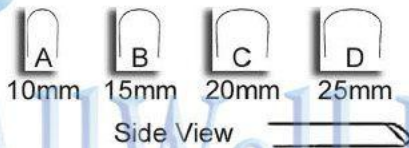

11-01-0549 Stille Gouge 20 cm / 8"

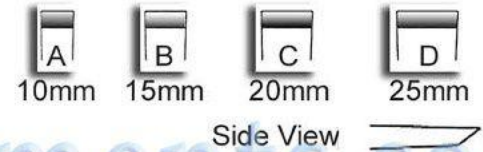

11-01-0550 Stille Chisel 20 cm / 8"

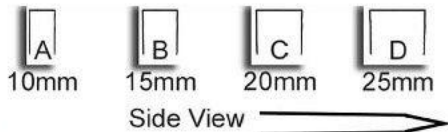

11-01-0551 Stille Osteotome 20 cm / 8"

11-01-555  
Lambotte, Osteotome  
24 cm / 9 1/2"  
Curved Tip



Side View  
Curved Tip



Available in

- 15mm
- 20mm
- 25mm
- 30mm
- 38mm
- 44mm
- 50mm



11-01-0552 (12.5 cm / 5") Lambotte, Mini Osteotome

11-01-0553 (17 cm / 6 3/4") Lambotte, Mini Osteotome  
3mm / 4mm / 6mm / 8mm / 10mm / 12mm / 15mm

11-01-0554 (24 cm / 9 1/2") Lambotte, Osteotome  
15mm / 20mm / 25mm / 30mm / 38mm / 44mm / 50mm





# AllWell Instruments co.

The name of Health Care Instruments

CHISELS - OSTEOTOMES - GOUGES

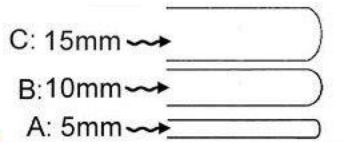

**11-01-0556A**

Lexer Spongiosa Gouge (25 cm / 9 3/4")

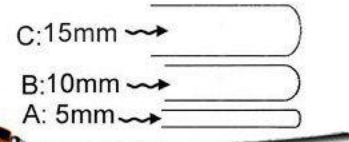

**11-01-0556B**

Lexer Spongiosa Gouge (25 cm / 9 3/4")



**11-01-0557A**

Lexer, Mini Osteotome 18.5 cm / 7 1/4"



**11-01-0557B**

Lexer, Mini Osteotome 18.5 cm / 7 1/4"



**11-01-0558A**

Lexer, Osteotome 22 cm / 8 3/4"

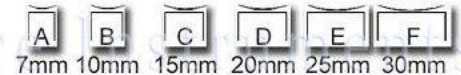

**11-01-0558B**

Lexer, Osteotome 22 cm / 8 3/4"



**11-01-0559**

Vickers Spongiosa Gouge 18 cm / 7"

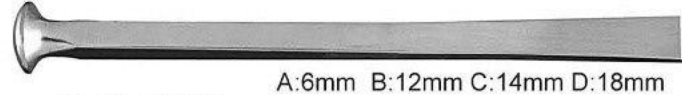

A: 6mm B: 12mm C: 14mm D: 18mm

**11-01-0560A**

US Army Chisel 18 cm / 7"



A: 6mm B: 12mm C: 14mm D: 18mm

**11-01-0560B**

US Army Osteotome 18 cm / 7"



A: 6mm B: 12mm C: 14mm D: 18mm

**11-01-0560C**

US Army Gouge 18 cm / 7"



TIP

**11-01-0561A**

Smith-Petersen Osteotome 20.5 cm / 8" Straight

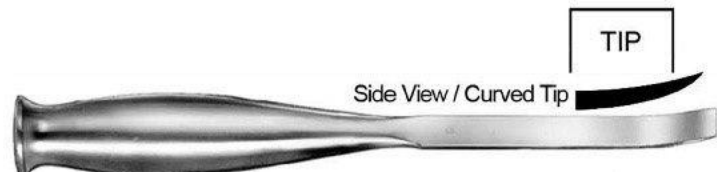

TIP

Side View / Curved Tip

**11-01-0561B**

Smith-Petersen Osteotome 20.5 cm / 8" Curved





# AllWell Instruments co.

The name of Health Cure Instruments

## CHISELS - OSTEOTOMES - GOUGES

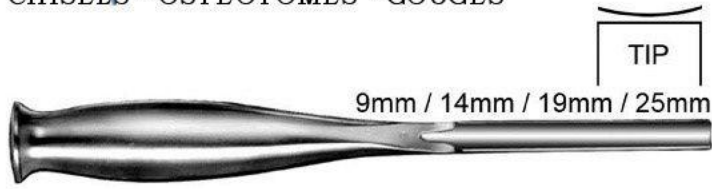

**11-01-0561C**

Smith-Petersen Gouge 20.5 cm / 8" Straight Tip

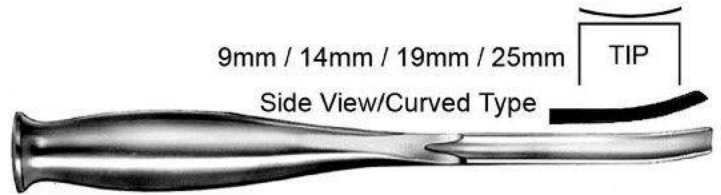

**11-01-0561D**

Smith-Petersen Gouge 20.5 cm / 8" Curved Tip



**11-01-0562**

Hook Osteotome 17 cm / 6 3/4"



**11-01-0563A**

Hibbs Osteotome 24.5 cm / 9 3/4"



**11-01-0563B**

Hibbs Chisel 24.5 cm / 9 3/4"



**11-01-0563C**

Hibbs Gouge 24.5 cm / 9 3/4"

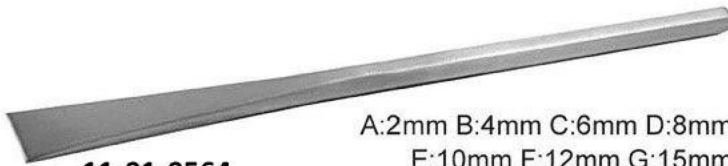

**11-01-0564**

Sheehan Osteotome 16cm / 6 1/2"



**11-01-0565A**

Silver Osteotome 18 cm / 7" Straight



**11-01-0565B**

Silver Osteotome 18 cm / 7" Curved Right



**11-01-0565C**

Silver Osteotome 18 cm / 7" Curved Left



**11-01-0566**

Shoulder Penetrating Gouge 21 cm / 8 1/2"



**11-01-0567**

Swan Neck Gouge 23 cm / 9"





# AllWell Instruments co.

The name of Health Cure Instruments

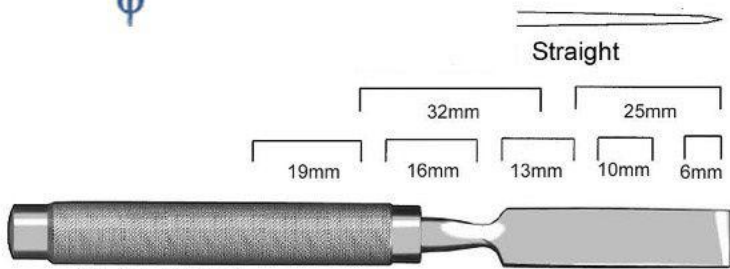

**11-01-0568A**

Cobb Osteotome 28 cm / 11" Straight

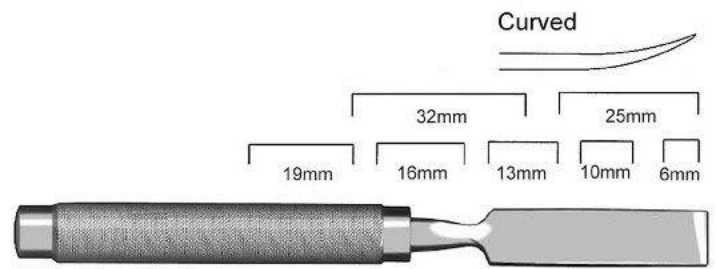

**11-01-0568B**

Cobb Osteotome 28 cm / 11" Curved

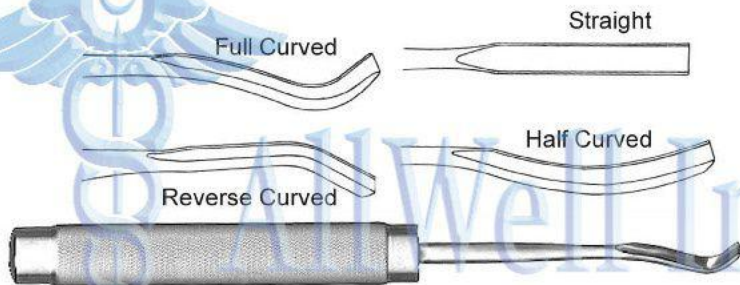

**11-01-0569**

Cobb Gouge 28 cm / 11"

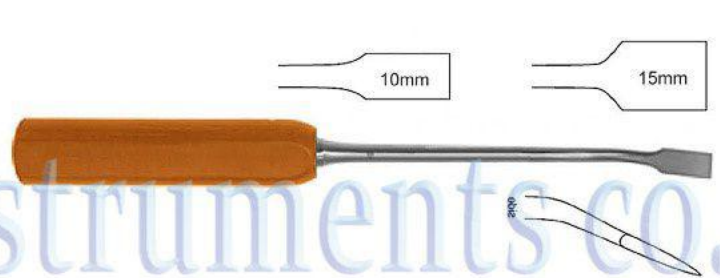

**11-01-0570**

Lexer Osteotome Angled / 28 cm / 11"

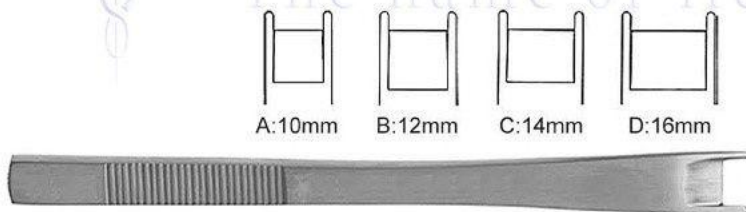

**11-01-0571**

Cinelli Osteotome 15.5 cm / 6 1/2"

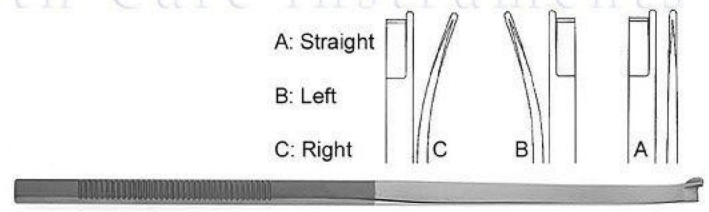

**11-01-0572**

Anderson Neivert Osteotome 20 cm / 8"



**11-01-0573**

Hibbs Osteotome 47 cm / 18 1/2" 10 mm Tip

3 1/2" Tip L / 10 3/4" Shaft L / 4 1/4" Handle L

11.5 mm Shaft Diameter

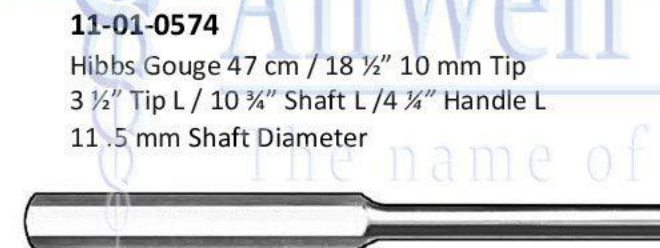
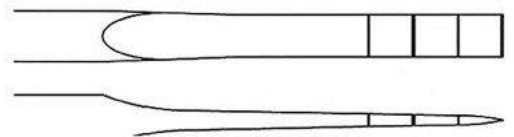

**11-01-0574**

Hibbs Gouge 47 cm / 18 1/2" 10 mm Tip

3 1/2" Tip L / 10 3/4" Shaft L / 4 1/4" Handle L

11.5 mm Shaft Diameter

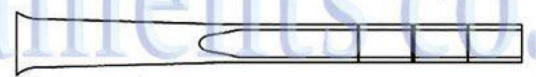



# AllWell Instruments co.

The name of Health Cure Instruments

CHISELS - OSTEOTOMES - GOUGES



11-01-0575

Spinal Fusion Gouge 24 cm / 9 1/2" 6 mm Tip

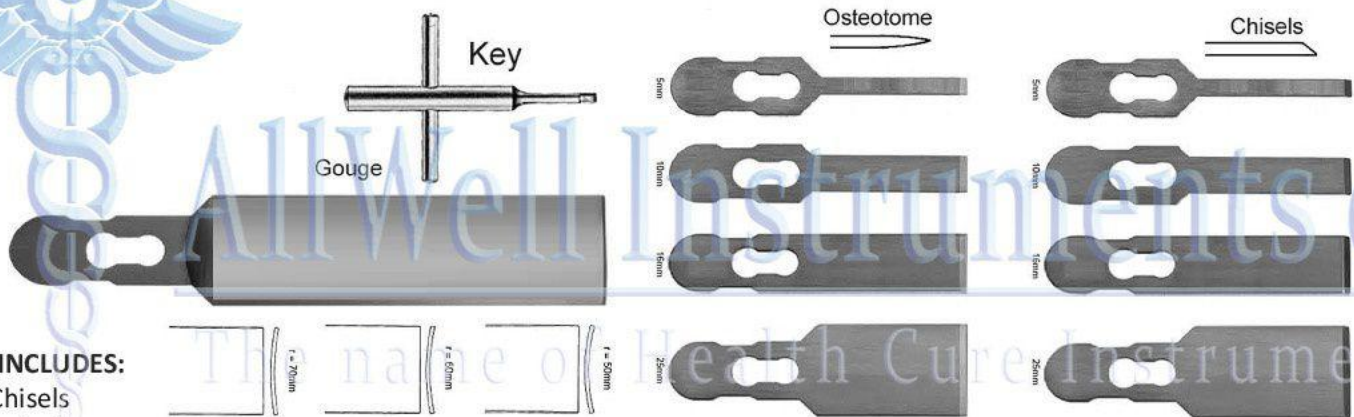

**SET INCLUDES:**

- 5 x Chisels
- 5/1 0/15/25mm
- 5 x Osteotomes
- 5/1 0/15/25mm
- 3 x Gouges
- 50/60/70mm Radius
- 1 x Handle Fibre
- 1 x Key



11-01-0576

Chisel Handle Fibre w/Chisel-Osteotome-Gouge Blades 18.5 cm / 7 1/4"



11-01-0577

Volkman Bone Curette 18.5 cm / 7 1/4" oval with plastic handle



11-01-0578

Volkman Bone Curette 27.5 cm / 10 3/4" oval with plastic handle





# AllWell Instruments co.

The name of Health Cure Instruments

## BONE CURETTES

- A: 13 cm / 5"
- B: 16 cm / 6 3/4"
- C: 20 cm / 8"



11-01-0579

Volkman Bone Curette, double-ended (oval / round)



11-01-0580

Bone Curette, double-ended (round / oval) 21 cm / 8 1/4"



11-01-0581

Schede Bone Curette 17 cm / 6 3/4" oval with hollow handle



11-01-0582

Volkman Bone Curette 17 cm / 6 3/4" oval, with hollow

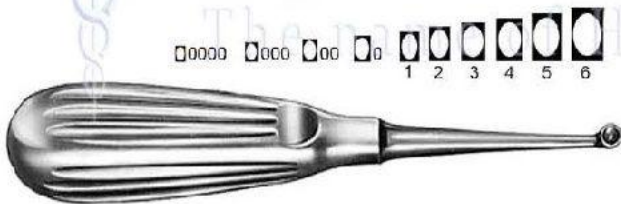

11-01-0583

Bruns Bone Curette 17 cm / 6 3/4" Round, with hollow handle

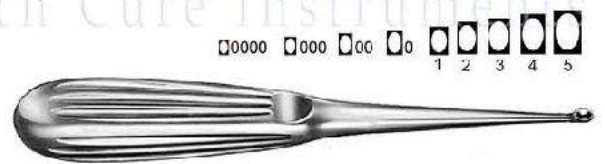

11-01-0584

Spratt Bone Curette 17 cm / 6 3/4" Oval, with hollow handle

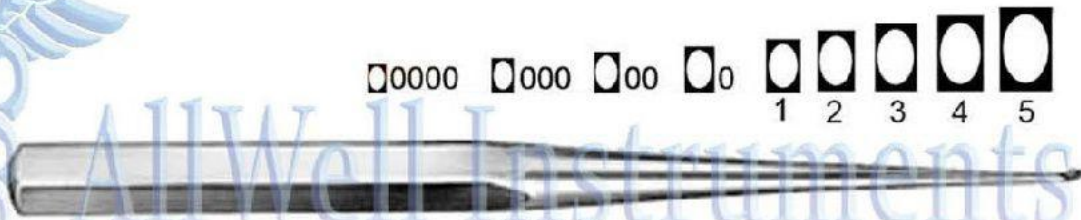

11-01-0585

Bruns Bone Curette 23 cm / 9" oval, solid



11-01-0586

Scoville Bone Curette 25 cm / 9 3/4" oval, with hollow handle



# AllWell Instruments co.

The name of Health Cure Instruments

BONE CURETTES



**11-01-0587**

Simon Bone Curette 25 cm / 9 3/4" oval, with hollow handle



**11-01-0588**

Modell USA Bone Curette 16 cm / 6 1/4" Oval, with hollow handle



**11-01-0589**

Modell USA Bone Curette 15.5 cm / 6" Oval, with hollow handle



**11-01-0590**

Model USA Bone Curette 15.5 cm / 6" Oval, with hollow handle





# AllWell Instruments co.

The name of Health Cure Instruments

## BONE CURETTES

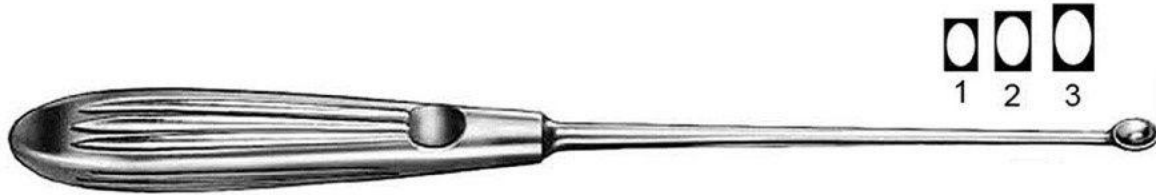

**11-01-0591**

Halle Bone Curette 21 cm / 8 1/4" oval, malleable shaft, with hollow handle

A: 00/0 ● / ● B: 0/1 ● / ● C: 1/2 ● / ●



Available in 3 sets of combination



**11-01-0592**

Williger Bone Curette, double-ended 13.5 cm / 5 1/4" handle



A: 00/00 ● / ● B: 0/0 ● / ● C: 1/1 ● / ●

**11-01-0593**

Williger Bone Curette, 17 cm / 6 3/4" double-ended oval / oval



A: 12.5 cm / 5"  
B: 14.5 cm / 5 3/4"  
C: 17 cm / 6 3/4"

**11-01-0594**

Volkmann Bone Curette, double-ended

A: 1 R/L ● / ● B: 2 R/L ● / ● C: 3 R/L ● / ●

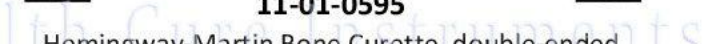

**11-01-0595**

Hemingway-Martin Bone Curette, double-ended  
18.5 cm / 7 1/4"

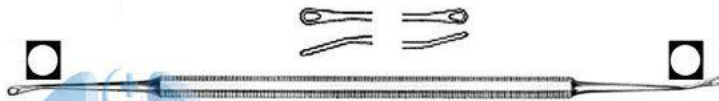

**11-01-0596**

Bone Curette, 17.5 cm / 7" double-ended round

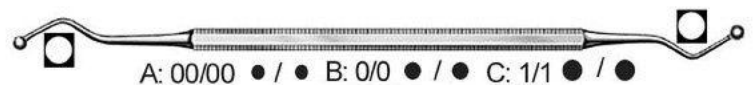

A: 00/00 ● / ● B: 0/0 ● / ● C: 1/1 ● / ●

**11-01-0597**

Hemingway Bone Curette, double-ended, round / round  
18.5 cm / 7 1/4" octagonal handle

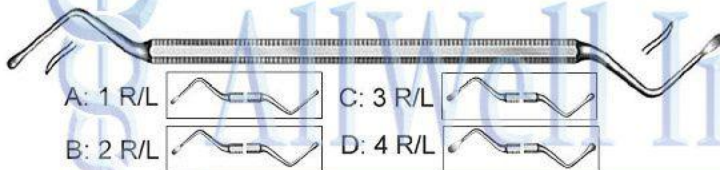

A: 1 R/L B: 2 R/L C: 3 R/L D: 4 R/L E: 5 R/L

**11-01-0598**

Lucas Bone Curette, double-ended 18 cm / 7"  
Octagonal handle

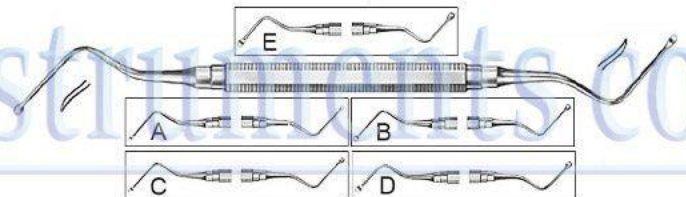

A: 1 R/L B: 2 R/L C: 3 R/L D: 4 R/L E: 5 R/L

**11-01-0599**

Miller-Colburn Bone Curette, double-ended 17 cm / 6 3/4"

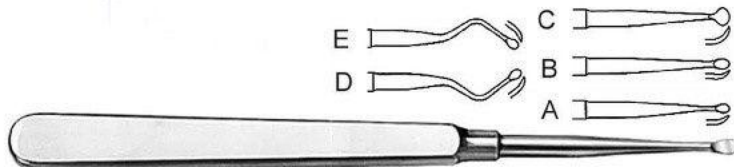

**11-01-0600**

Molt Bone Curette 17 cm / 6 3/4"

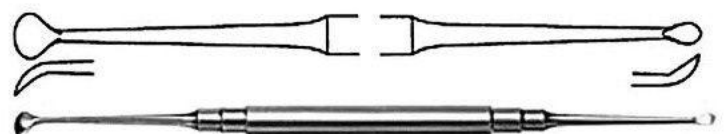

**11-01-0601**

Molt Bone Curette 19 cm / 7 1/2" Round Handle









# AllWell Instruments co.

The name of Health Cure Instruments **BONE CURETTES**

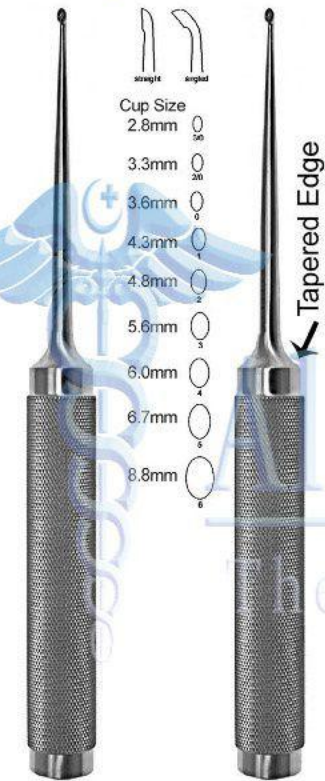

Hollow Handle Solid Handle  
**11-01-0610**  
 Cobb Curette Oval Cups  
 28 cm / 11"

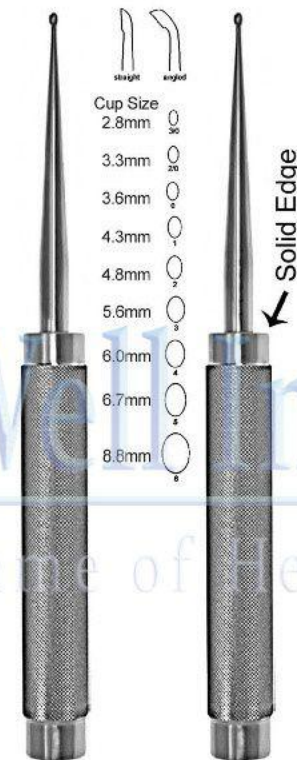

Hollow Handle Solid Handle  
**11-01-0611**  
 Cobb Curette Oval Cups  
 28 cm / 11"

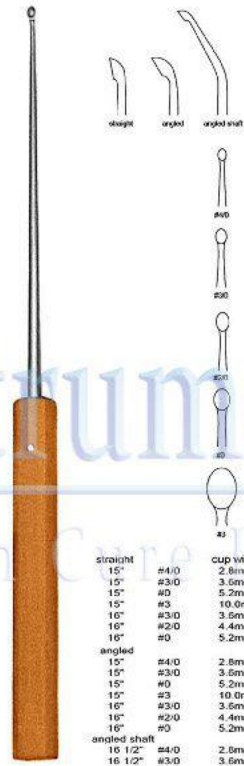

**11-01-0612**  
 Sybert Curette Long  
 Delicate Shaft



Knurled Aluminum Handle  
**11-01-0613**  
 Cone Ring Curette  
 23 cm / 9"

- A: Straight 8mm Sharp/Blunt
- B: Straight 11 mm Sharp/Blunt
- C: Angled 8mm Sharp/Sharp
- D: Angled 11 mm Sharp/Sharp
- E: Angled 8mm Sharp/Sharp Right Cvd

- F: Angled 11 mm Sharp/Sharp Right Cvd
- G: Angled 8mm Sharp/Sharp Left Cvd
- H: Angled 11 mm Sharp/Sharp Left Cvd

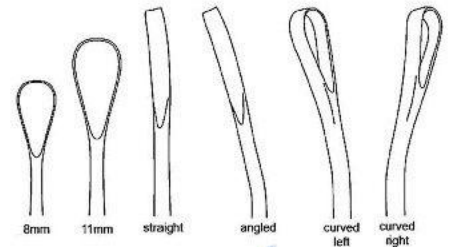

**11-01-0614**  
 Zielke Ring Curette 34 cm / 13 1/2" TEFLON Handle

17" Angled 40° 3mm Diameter 2.7"  
 Tip Length Cone Ring Curette  
 Endoscopic Fibre Handle 9.3" Shaft  
 Length 5" Handle Length .285 (7  
 .2mm) Shaft Diameter



20" Angled 30°  
 6mm Diameter  
 3 1/2" Tip Length  
 10" Shaft Length  
 6 1/2" Handle Length  
 45" (11 .5mm)  
 Shaft Diameter

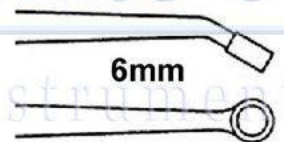

**11-01-0615**  
 Cone Ring Curette Endoscopic Fibre Handle





# AllWell Instruments co.

The name of Health Cure Instruments

## BONE CURETTES

17" Reverse Angled 40° 3mm x 6mm cup  
2.7" Tip Length 9.3" Shaft Length 5" Handle  
Length.285 (7.2mm) Shaft Diameter

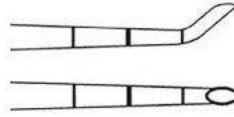

20" Reverse Angled 30°  
6mm x 9mm cup 3 1/2"  
Tip Length 10" Shaft  
Length 6 1/2" Handle  
Length .45 (7.2mm)  
Shaft Diameter

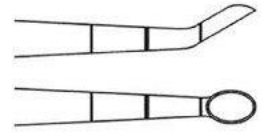

**11-01-0616**

Epstein Curette Endoscopic Fibre Handle

A: 17cm / 6 3/4" 8mm | B: 19cm / 7 1/2" 16 mm | E: 18.5cm / 7" 12 mm  
C: 19cm / 7 1/2" 16 mm | D: 18.5cm / 7 1/4" 12 mm

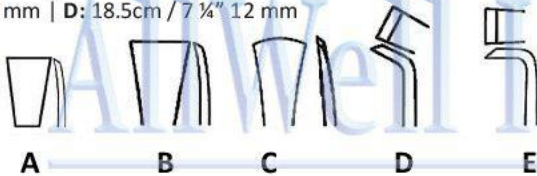

**11-01-0617**

Martin-Langenbeck Periosteal Elevator (Solid)

B: 18.5cm / 7 1/4" 15mm tip

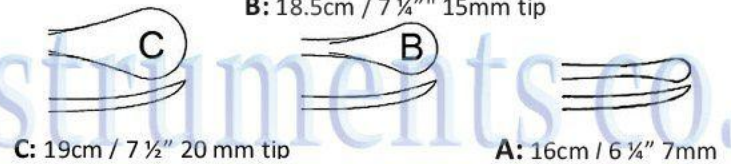

**11-01-0618**

Martin-Langenbeck Periosteal Elevator (Solid)

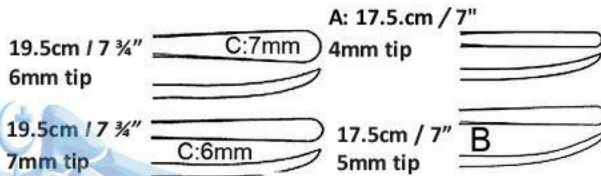

**11-01-0619**

Martin-Langenbeck Periosteal Elevator (Solid)



**11-01-0620**

Langenbeck Periosteal Elevator 18.5 cm / 7 1/4"  
With hollow handle



**11-01-0621**

Langenbeck Periosteal Elevator 19.5 cm / 7 3/4"  
With hollow handle

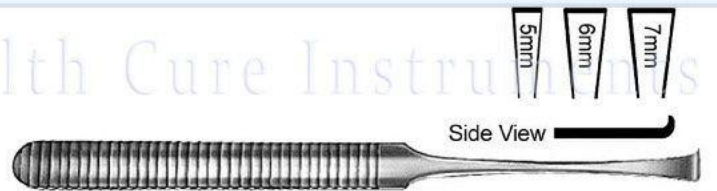

**11-01-0622**

Periosteal Elevator 16 cm / 6 1/4" Delicate, solid





# AllWell Instruments co.

The name of Health Cure Instruments

## PERIOSTEAL ELEVATORS

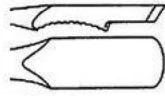

**11-01-0623**

Farabeuf Periosteal Elevator 15 cm / 6"  
With hollow handle

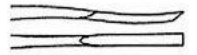

**11-01-0624**

Periosteal Elevator 3mm Tip 18 cm / 7"  
Extra narrow, with plastic handle



**11-01-0625**

Kahre-Williger 16 cm / 6 1/4"  
Periosteal Elevator solid

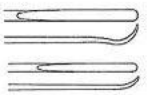

**11-01-0626**

Kahre-Williger Periosteal Elevator solid  
16cm / 6 1/4"



**11-01-0627**

Farabeuf Periosteal Elevator  
15 cm / 6" with hollow handle

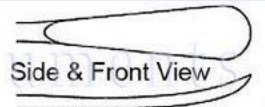

**11-01-0628**

Sedillot Periosteal Elevator 22 cm / 8 3/4" (15mm tip)



**11-01-0629**

Periosteal Elevator 20 cm / 8" (14 mm Tip)  
With plastic handle

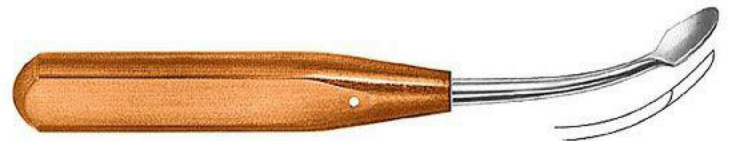
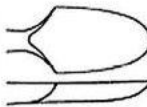

**11-01-0630**

Periosteal Elevator 19 cm / 7 1/2"  
(14 mm Tip) with plastic handle



**11-01-0631**

Periosteal Elevator 6mm Tip  
18 cm / 7" narrow, plastic handle



**11-01-0632**

Periosteal Elevator 18 cm / 7" narrow,  
Plastic handle (6mm Tip)

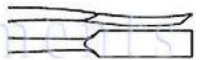





# AllWell Instruments co.

The name of Health Cure Instruments

## PERIOSTEAL ELEVATORS - DISSECTORS

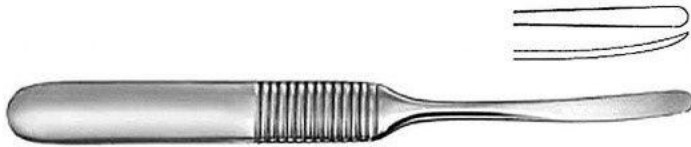

**11-01-0633**

Williger Periosteal Elevator  
12.5 cm / 5" solid 5mm Tip



**11-01-0634**

Periosteal Elevator,  
Double ended 17.5 cm / 7"

**11-01-0635**

Semb Periosteal Elevator

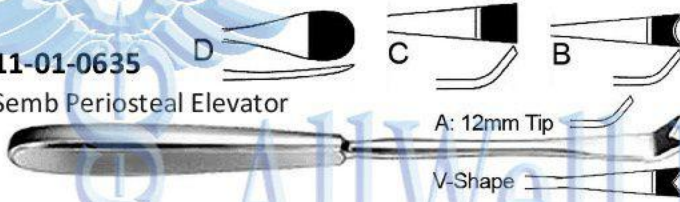

A+D: 21cm / 8 1/4" & B+C: 18.5 cm / 7 1/4"  
A: V-shape 12mm | B: Inside round 12mm  
C: Straight 13mm | D: Outer round 15mm

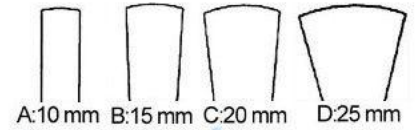

**11-01-0636**

Lambotte Periosteal Elevator 21.5 cm / 8 1/2"



**11-01-0637**

Periosteal Elevator 20 cm / 8" with plastic handle



**11-01-0638**

Periosteal Elevator 17 cm / 6 3/4" with hollow handle

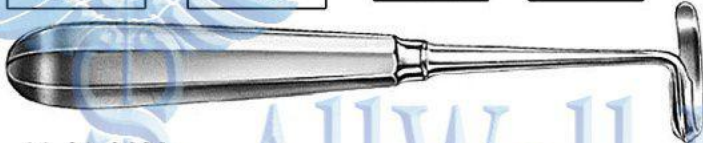
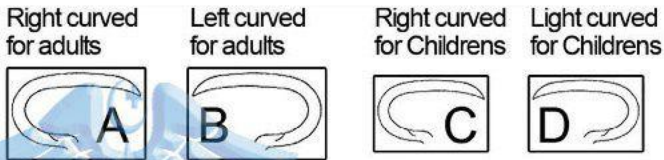

**11-01-0639**

Doyen Rib Raspatory 17.5 cm / 7" Rib Raspatories with hollow handle

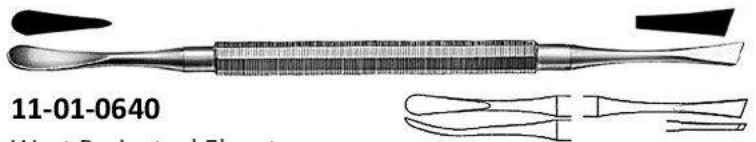

**11-01-0640**

West Periosteal Elevator,  
Double-ended 18.5 cm / 7 1/4" octagonal handle

**11-01-0641**

Williger Elevator  
17 cm / 6 3/4" 7mm tip



**11-01-0643**

Elevator 17 cm / 6 3/4" Light weight

**11-01-0642**

Williger Elevator  
16 cm / 6 1/4" (5.5mm tip)







# AllWell Instruments co.

The name of Health Cure Instruments

PERIOSTEAL ELEVATORS - DISSECTORS

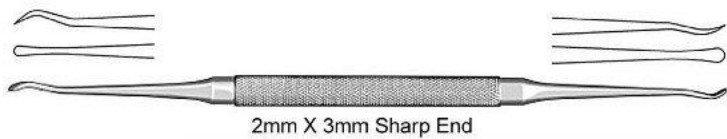

2mm X 3mm Sharp End

11-01-0644

Kleinert Kutz Elevator 14 cm / 5 1/2"



11-01-0645

Vickers Dissector 17 cm / 6 3/4"

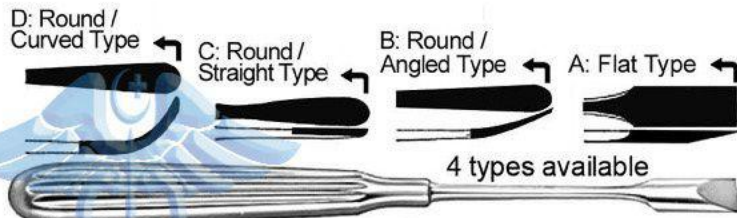

D: Round / Curved Type

C: Round / Straight Type

B: Round / Angled Type

A: Flat Type

4 types available

11-01-0646

Adson Elevator 17.5 cm / 7" A/B/C/D

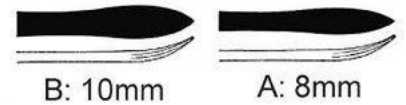

B: 10mm

A: 8mm

11-01-0647

Langenbeck Elevator 19.5 cm / 7 3/4" A/B

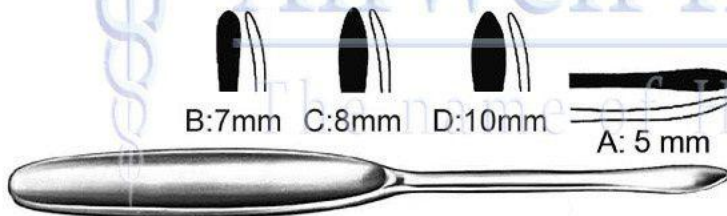

B: 7mm

C: 8mm

D: 10mm

A: 5 mm

11-01-0648

Martin Langenbeck Elevator 17 cm / 6 3/4" A/B/C | D: 19.5 cm / 7 3/4"

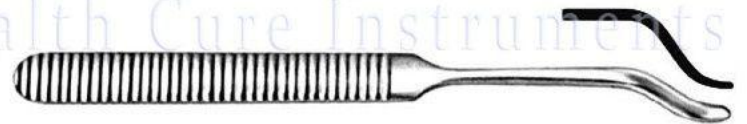

11-01-0649

Phalangeal Elevator 16cm / 6 1/4"



11-01-0650

Alderdyce Dissector, double-ended 21 cm / 8 1/4"



11-01-0651

McDonald Dissector, double-ended 18.5 cm / 7 1/4"



11-01-0652

Freer Elevator 19 cm / 7 1/2"



11-01-0653

Penfield Elevator Endoscopic 38 cm / 15" 5mm Semi Sharp / 1X10mm Blunt Hook



11-01-0654

Smithwick Hook and Dissector 30 cm / 12" 5mm Semi Sharp / 1X10mm Blunt Hook





# AllWell Instruments co.

The name of Health Cure Instruments

PERIOSTEAL ELEVATORS - RESPIATORIES

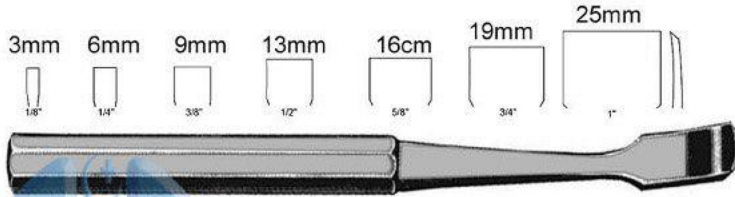

**11-01-0655**

Key Elevator 19 cm / 7 1/2" Sharp Edge

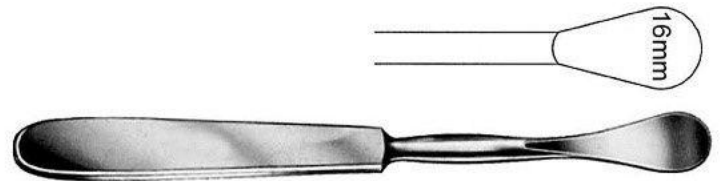

**11-01-0656**

Sedilot Elevator 18 cm / 7" Sharp Edge



**11-01-0657**

Alexander Periosteal Respiratory 20 cm / 8" / 12mm Sharp

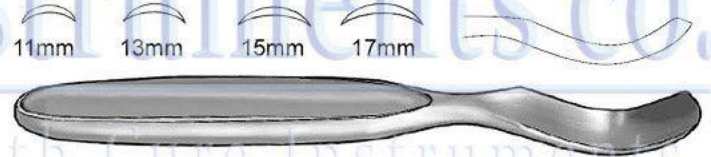

**11-01-0658**

MeGiamry Metatarsal Elevator 16 cm / 6 1/2" Sharp

- A: 19cm / 7 1/2" 13mm
- B: 20cm / 8" 19mm
- C: 23cm / 9" 25mm
- D: 25.5cm / 10" 30mm

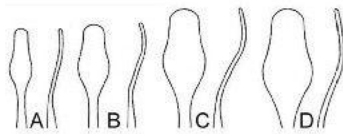

**11-01-0659**

Chandler Elevator Blunt



**11-01-0660**

Sayre Elevator 16 cm / 6 1/2"  
A: Sharp / Blunt B: Blunt / Blunt



**11-01-0661**

Kirmission Periosteal Respiratory 17 cm / 6 3/4"



**11-01-0662**

Periosteal Elevator 17cm / 6 3/4" Fibre Handle  
13mm Blade Sharp

- A: 14mm Full Curves
- B: 14mm Slight Curves
- C: 7mm Full Curves
- D: 7mm Slight Curves

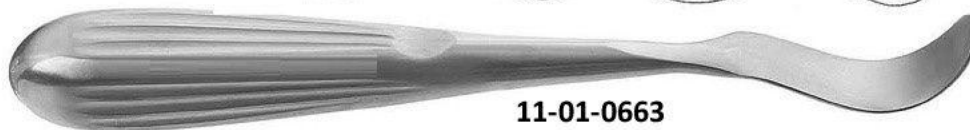
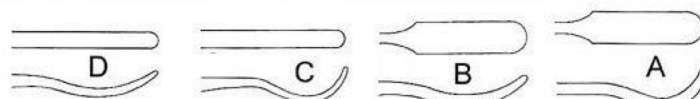

**11-01-0663**

Crego Periosteal Elevator 19 cm / 7 3/4" Sharp





# AllWell Instruments co.

The name of Health Cure Instruments

PERIOSTEAL ELEVATORS - DISSECTORS

**Small**

A: 26 cm / 10 1/4" 13mm Width at Tip

**Medium**

B: 26 cm / 10 1/4" 20mm Width at Tip

**Large**

C: 35 cm / 13 3/4" 25mm Width at Tip

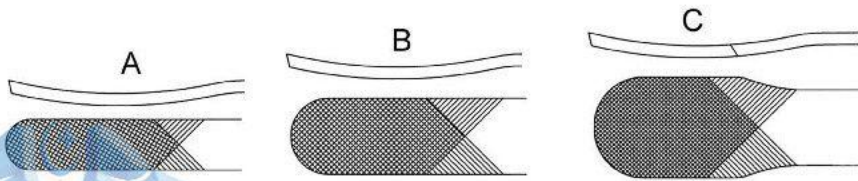

**11-01-0664**

Darraeh Elevator Blunt



**11-01-0665**

Cobb Spinal Elevator Sharp 24cm / 9 1/2" Hexa Handle

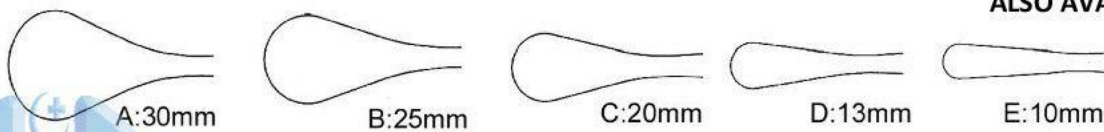

ALSO AVAILABLE WITH FIBRE HANDLE



**11-01-0666**

Spinal Elevator Sharp 28 cm / 11" Knurled Handle

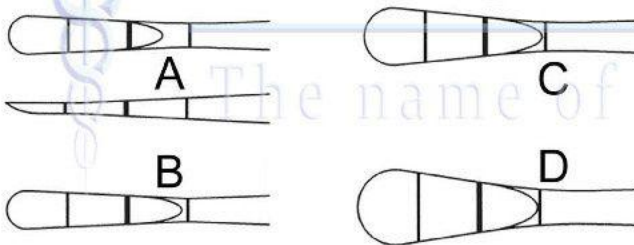

<b>A:</b> 43cm / 17"	<b>B:</b> 50cm / 20"	<b>C:</b> 50cm / 20"	<b>D:</b> 50cm / 20"
6mm Tip Width	6mm Tip Width	10mm Tip Width	13mm Tip Width
2.7" Tip Length	3 1/2" Tip Length	3 1/2" Tip Length	3 1/2" Tip Length
9.3" Shaft Length	10" Shaft Length	10" Shaft Length	10" Shaft Length
5" Handle Length	6 1/2" Handle L	6 1/2" Handle L	6 1/2" Handle L
7.2mm Shaft Dia	11.5mm Shaft Dia	11.5mm Shaft Dia	11.5mm Shaft Dia



**11-01-0667**

Cobb Elevator Endoscopic Sharp / Fibre Handle





# AllWell Instruments co.

The name of Health Cure Instruments

ELEVATORS SPINAL - S/S & FIBRE

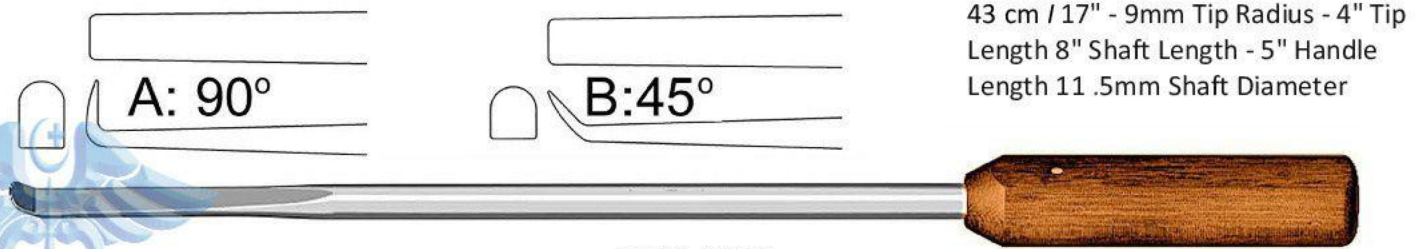

11-01-0668

Rib Elevator Endoscopic Sharp / Fibre Handle

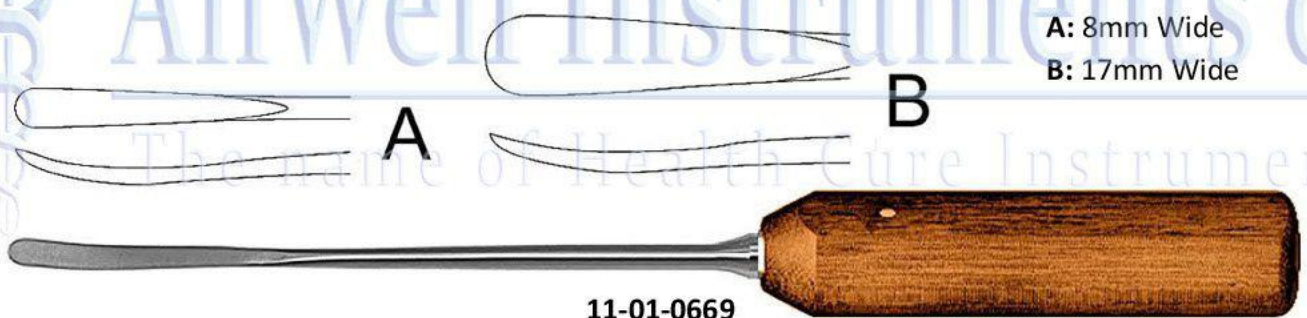

11-01-0669

Wagner Elevator Sharp / Fibre Handle 33 cm / 13"

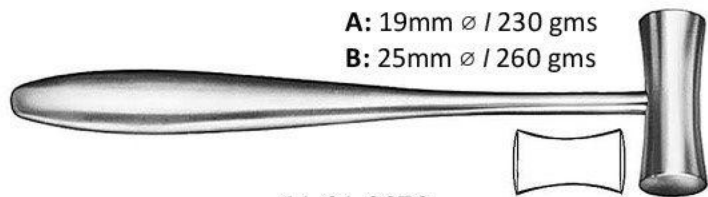

11-01-0670

Lucae Mallet 19.5 cm / 7 3/4"



11-01-0671

Cottle Mallet Plane / Convex  
19 cm / 7 1/2" 30mm ø / 300 gms

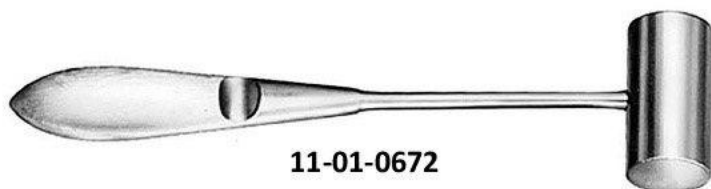

11-01-0672

Williger Mallet 16.4cm / 6 1/2"  
20 mm ø / 140 gms



11-01-0673

Mallet 26 cm / 10 1/4"  
30 mm ø / 510 gms



11-01-0674

Mead Mallet 19 cm / 7 1/2"  
With interchangeable plastic disks



11-01-0675

Partsch Mallet 19 cm / 7 1/2"  
With hollow handle 22mm ø / 200 gms





# AllWell Instruments co.

The name of Health Cure Instruments

ORTHOPEDIC MALLETS - S/S & FIBRE



11-01-0676

Mallet 26 cm / 10 1/4" with lead filling  
42mm ø / 400 gms



11-01-0677

Mallet 26 cm / 10 1/4" without lead filling  
42mm ø / 400 gms

- A: 26mm ø / 300 gms
- B: 28mm ø / 340 gms
- C: 30mm ø / 400 gms



11-01-0678

Williger Mallet 24 cm / 9 1/2" lead filled  
42mm ø / 400 gms



11-01-0679

Mallet 30 mm ø / 675 gms  
26.5 cm / 10 1/2" plane (Teflon) / convex (steel)



11-01-0680

Mallet 26 cm / 10 1/4"  
42 / 30mm ø / 530 gms



11-01-0681

Mallet 24 cm / 9 1/2"  
30 mm ø / 480 gms



Spare facings (Pair)



11-01-0682

Mallet 24 cm / 9 1/2"  
Disks and handle of Fiber 37 mm ø / 370 gms



11-01-0683

Mallet 22 cm / 8 3/4"  
30 mm ø / 125 gms

- A: 20 .5cm / 8" | 25mm ø / 120 gms
- B: 21cm / 8 1/4" | 30mm ø / 180 gms
- C: 21.5cm / 8 1/2" | 35mm ø / 260 gms



11-01-0684

Mallet 26.5 cm / 10 1/2" | 30 mm ø / 450 gms

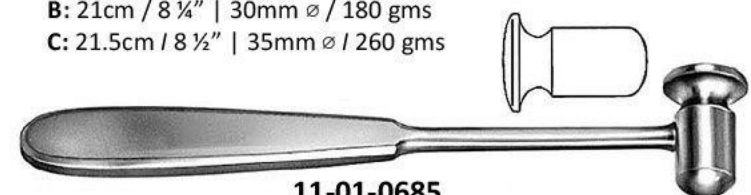

11-01-0685

Doyen Mallet





# AllWell Instruments co.

The name of Health Cure Instruments

ELEVATORS SPINAL - S/S & FIBRE



**11-01-0686**

Herbert Mallet 19 cm / 7 1/2"  
For ulnar head prosthesis



**11-01-0687**

Collin Mallet 20 cm / 8"  
23 mm ø / 220 gms



**11-01-0688**

Mallet 26.5 cm / 10 1/2"  
50 mm ø / 900 gms

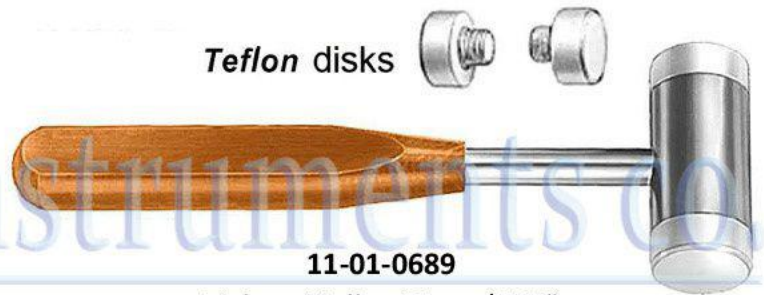

Teflon disks

**11-01-0689**

Vickers Mallet 19 cm / 7 1/2"  
25 mm ø / 300 gms

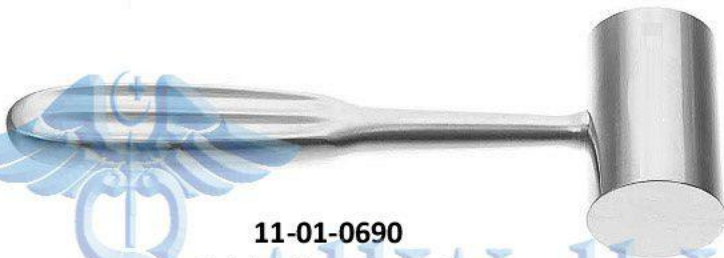

**11-01-0690**

Kirk Mallet 20cm / 8"  
Head Dia 38mm / Weight: 1 lb. 4 oz. (570 grams)



Head Weight: 7 oz (200 grams)

**11-01-0691**

Gerzog Mallet 19 cm / 7 1/2"  
Head Dia 25mm / Weight 10 oz (285 grams)



Head Weight: 20 oz (567 grams)

**11-01-0692**

Heath Mallet 19 cm / 7 1/2"  
Head Dia 40mm / Weight 2 lbs. (907gm)

Head Weight: 20 oz (567 grams)



**11-01-0693**

Heath Mallet, SS 18 cm / 7" Solid Frame Handle  
Head Dia 40mm / Weight 36 oz. (1020gm)





# AllWell Instruments co.

The name of Health Cure Instruments

ELEVATORS SPINAL - S/S & FIBRE



**11-01-0694**

All Fibre Mallet 24 cm / 9 1/2"  
Head Dia 80X60mm Weight 14oz. (397gm)



Fibre Handle

**11-01-0695**

Cloward Mallet 19cm / 7 1/2"  
Head Dia 20mm / Weight 8oz. (227gm)



**11-01-0696**

Hajek Mallet 20 cm / 8"  
Head Dia 27mm / Weight: 7 oz. (198gm)



Fibre Handle

**11-01-0697**

Narrow Tip Mallet 20cm / 8"  
Head Dia 7mm Weight 6oz. (170gm)

B: Head Dia 35mm Weight 11b 40 oz. (570gm)  
C: Head Dia 40mm Weight 11b 90 oz. (708gm)



**11-01-0698**

Fibre Handle Mallet 23cm / 9"

A: Head Dia 30mm / Weight 12 oz. (340gm)



**11-01-0699**

He-Man Mallet 28cm / 11"

Head Dia 38mm / 24mm / Weight 21b (906gm)





# AllWell Instruments co.

The name of Health Cure Instruments

MENISCUS - TENDON - CARTILAGE INSTRUMENTS

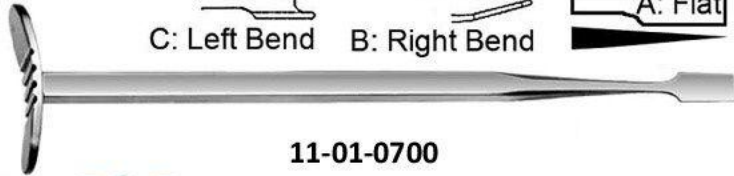
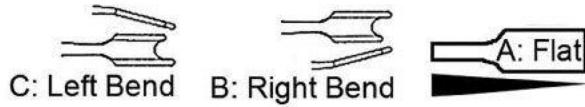

11-01-0700

Smillie Meniscus Knife 18 cm / 7"

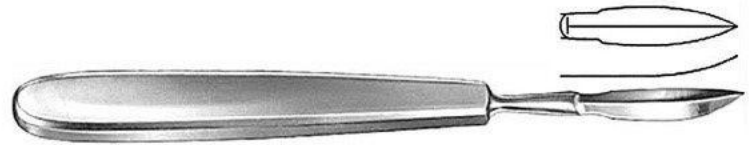

11-01-0701

Meniscus Knife 18 cm / 7"



11-01-0702

Neff Meniscus Knife 22 cm / 8 3/4"



11-01-0703

Salenius Meniscus Knife 21 cm / 8 1/4" A: Right / B: Left



11-01-0704

Bunnell Tendon Stripper 15 cm / 6"



11-01-0705

Fischer Tendon Stripper 31 cm / 12 1/4" Blunt



11-01-0706

Tendon Passing Instrument 33.5 cm / 13 1/4"



11-01-0707

Fischer Tendon Stripper 31 cm / 12 1/4" Blunt



11-01-0708

Tendon Stripper 3 / 4 / 5 / 6mm  
A: 28.5 cm / 11 1/4" B: 60 cm / 24"



11-01-0709

Bunnell Tendon Passer 23 cm / 9" Malleable

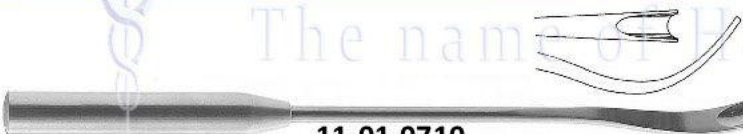

11-01-0710

Downing Cartilage Knife 25 cm / 10"  
Concave Edge Cvd Blade w/ Guards



11-01-0711

Lowe Breck Cartilage Knife 25cm/10" STR Edge-Cvd Blade w / Guards



11-01-0712

Tendon Stripper 40 cm / 16" Fibre Handle





# AllWell Instruments co.

The name of Health Cure Instruments

## TENDON INSTRUMENTS



Cvd Serrated Blades

**11-01-0713**

Martin Cartilage Scissors 20cm / 8"

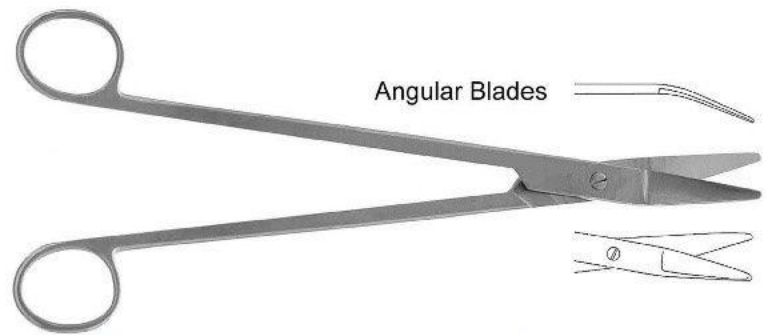

Angular Blades

**11-01-0714**

Mueller Capsule Scissors 24 cm / 9 1/2"

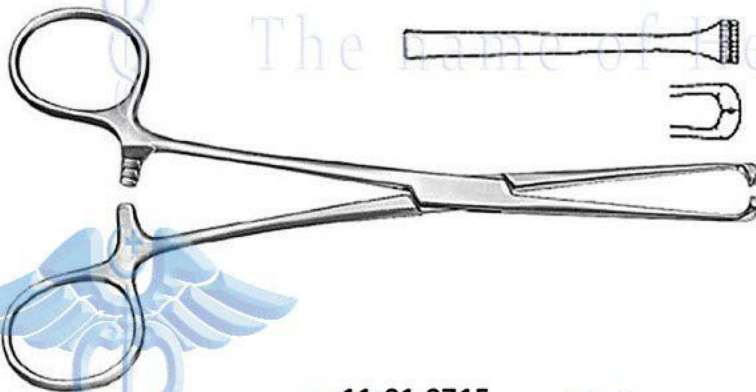

**11-01-0715**

Steinmann Tendon Holding Forceps 16 cm / 6 1/4"



A: [Diagram of jaw A]  
B: [Diagram of jaw B]  
C: [Diagram of jaw C]

**11-01-0716**

Brand Tendon Tunneling Forceps

A: 15cm | 6" | 1:2 Teeth

B: 19cm | 7 1/2" | 1:2 Teeth

C: 24.5cm | 9 3/4" | 1:2 Teeth

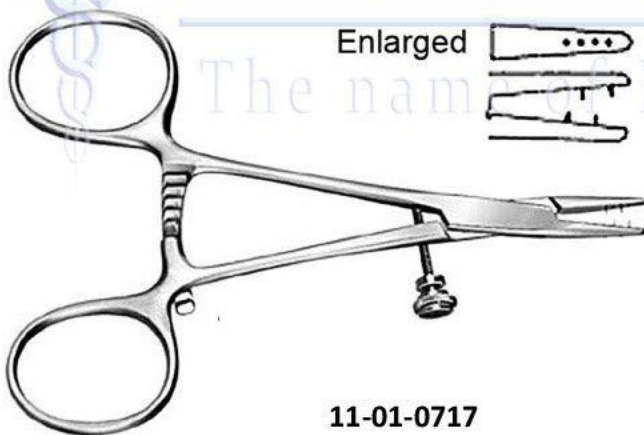

Enlarged

**11-01-0717**

Tendon Holding Forceps

11.5cm / 4 1/2"

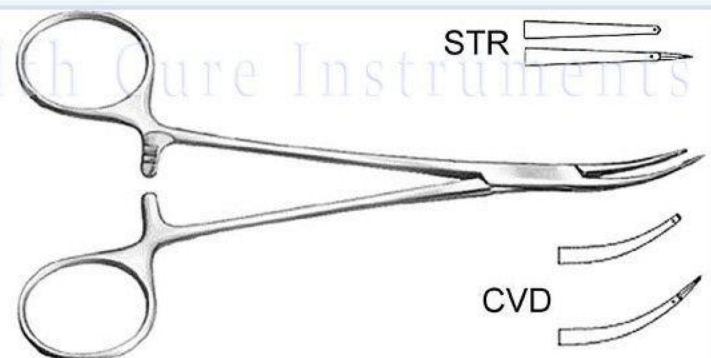

STR

CVD

**11-01-0718**

Tendon Interlacing Forceps

15.5 cm / 6" Pointed



# AllWell Instruments co.

The name of Health Cure Instruments

TENDON INSTRUMENTS



**11-01-0719-1**  
Carroll Tendon Holding Forceps  
11.5 cm / 4 1/2"

AllWell Instruments co.

The name of Health Cure Instruments

**11-01-0719-2**  
Hallman Tendon  
Tunneling Forceps  
21 cm / 8 1/4"



A: Straight 1:2 Teeth

B: Curved 1:2 Teeth

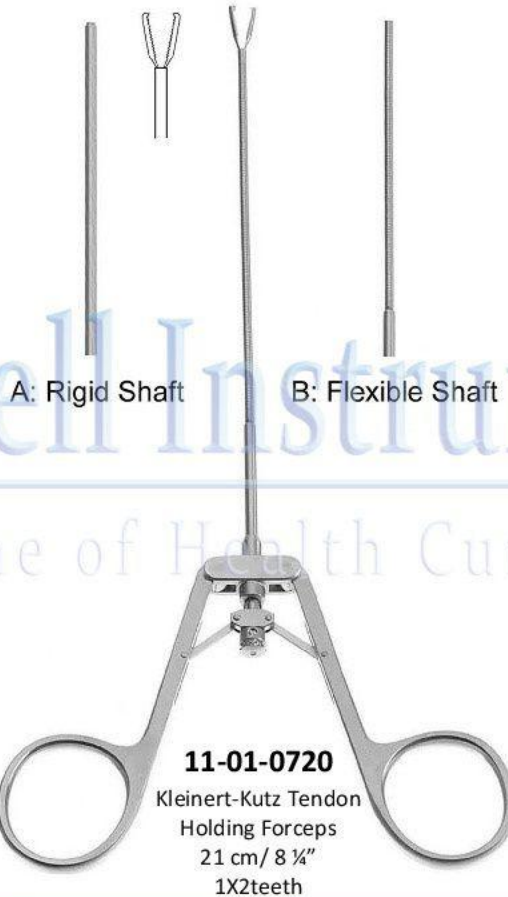

A: Rigid Shaft

B: Flexible Shaft

**11-01-0720**  
Kleinert-Kutz Tendon  
Holding Forceps  
21 cm / 8 1/4"  
1X2teeth



**11-01-0721**  
Hoen Grasping Forceps  
14 cm / 5 1/2" (Shaft)  
1X2 teeth





# AllWell Instruments co.

The name of Health Cure Instruments

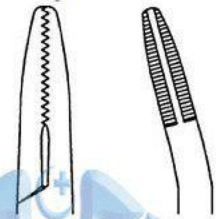

Serrated Jaw  
Angled 20°

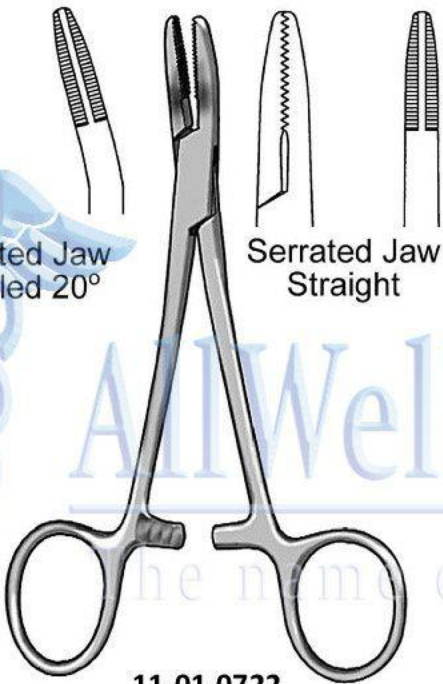

**11-01-0722**

Meniscus Clamp

13.5 cm / 5 3/8" 1X2 teeth

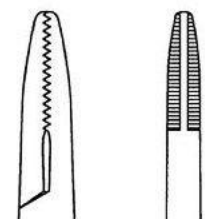

Serrated Jaw  
Straight

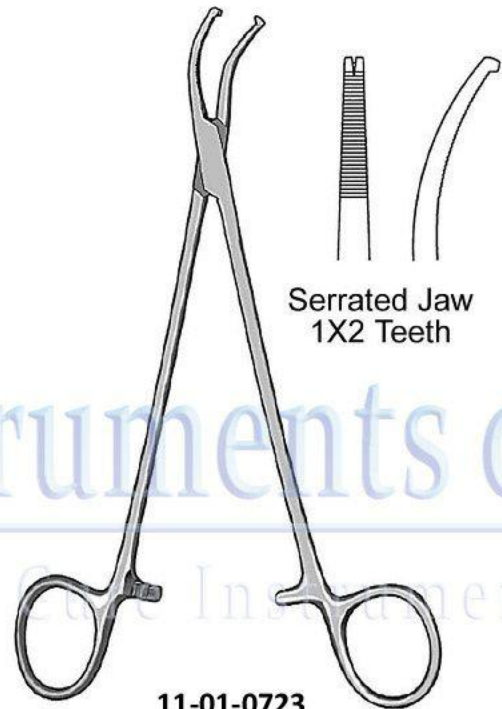

**11-01-0723**

Preston Ligamentum Flavum Forceps  
(Meniscus) 18.5 cm / 7 1/4"

Serrated Jaw  
1X2 Teeth



Straight



Angled

**11-01-0724**

Ortho Grasper 21 cm / 8 1/2"

7 X 20 MM Bite



# AllWell Instruments co.

The name of Health Cure Instruments

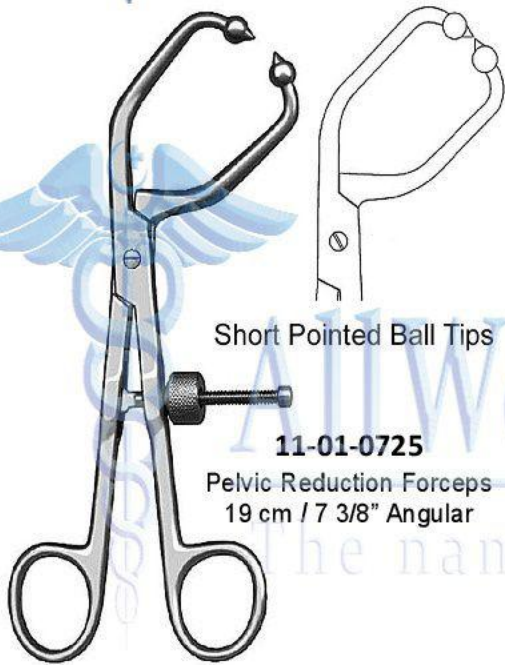

Short Pointed Ball Tips

**11-01-0725**  
Pelvic Reduction Forceps  
19 cm / 7 3/8" Angular

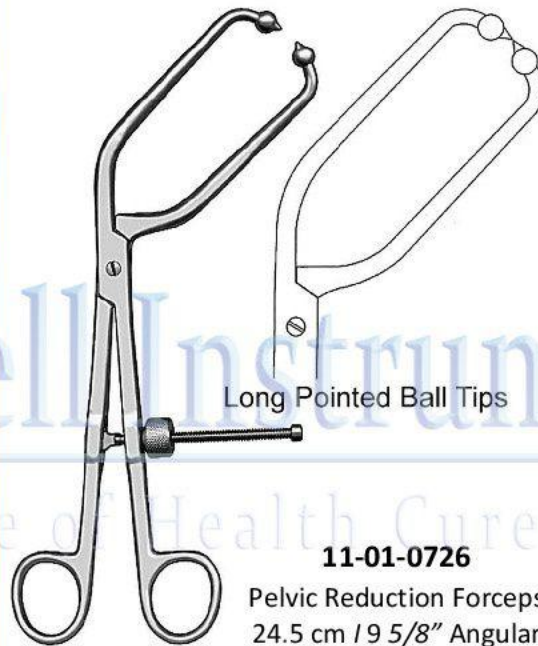

Long Pointed Ball Tips

**11-01-0726**  
Pelvic Reduction Forceps  
24.5 cm / 9 5/8" Angular

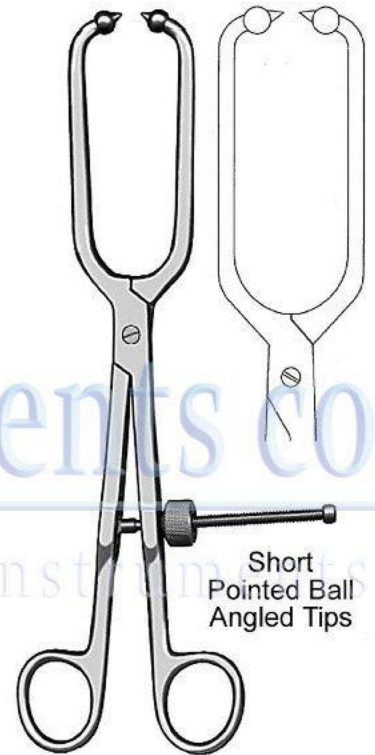

Short  
Pointed Ball  
Angled Tips

**11-01-0727**  
Pelvic Reduction Forceps  
25 cm / 10"



Long  
Pointed Ball Tips

**11-01-0728**  
Pelvic Reduction Forceps  
Available in 2 Sizes  
A: 24 cm / 9 1/2"  
B: 41cm / 16"

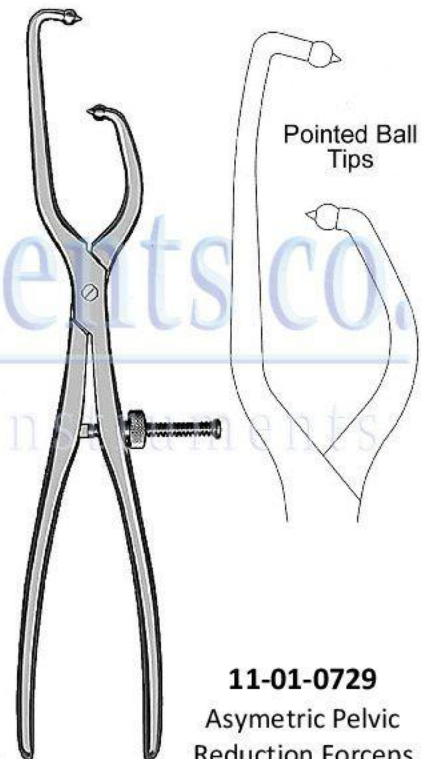

Pointed Ball  
Tips

**11-01-0729**  
Asymmetric Pelvic  
Reduction Forceps  
41 cm / 16"





# AllWell Instruments co.

The name of Health Cure Instruments

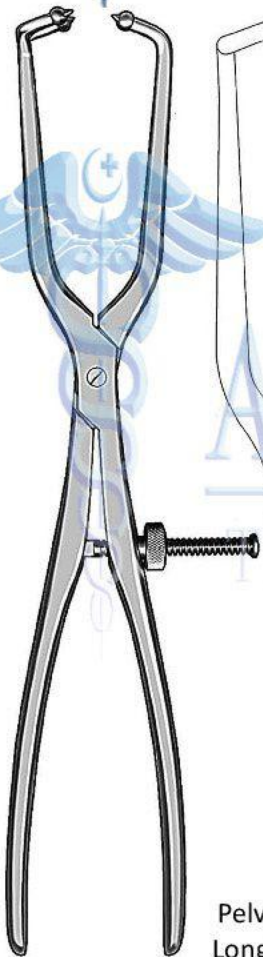

**11-01-0730**  
Pelvic Reduction Forceps  
Long 1X2 Pointed Ball Tips  
41 cm / 16"

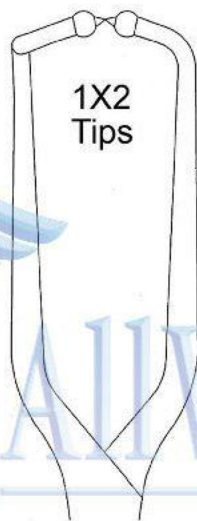

1X2  
Tips

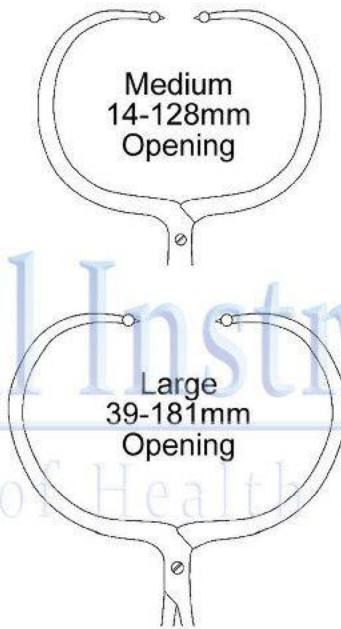

Medium  
14-128mm  
Opening

Large  
39-181mm  
Opening



**11-01-0731**  
Periarticular Reduction Forceps  
Straight / Pointed Ball Tips  
38 cm / 15"



**11-01-0732**  
Pelvic Reduction Forceps  
Adjustable Jaws for Screws  
A: 25 cm / 10" B: 33 cm / 13"



# AllWell Instruments co.

The name of Health Cure Instruments

## BONE HOLDING FORCEPS



**11-01-0733**

Bone Holding Forceps  
14 cm / 5 1/2"



**11-01-0734**

Lewin Bone Holding Forceps  
18.5 cm / 7 1/4"



**11-01-0735**

Bone Holding Forceps  
14 cm / 5 1/2" Delicate



**11-01-0736**

Frosch Bone Holding Forceps 18 cm / 7"



**11-01-0737**

Bone Holding Forceps 20 cm / 8"



**11-01-0738**

Semb Bone Holding Forceps 19 cm / 7 1/2"

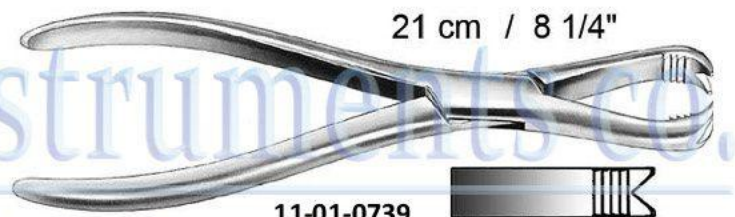

**11-01-0739**

Lengenbeck Bone Holding Forceps 21 cm / 8 1/4"

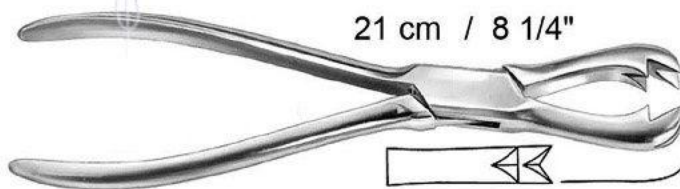

**11-01-0740**

Fergusson Bone Holding Forceps Heavy pattern  
21 cm / 8 1/4"



**11-01-0741**

Farabeuf Bone Holding Forceps  
A: 23 cm / 9" B: 26 cm / 10 1/4"





# AllWell Instruments co.

The name of Health Cure Instruments

BONE HOLDING FORCEPS



**11-01-0742**

Kern Bone Holding Forceps

**A:** 17 cm / 6 <sup>3</sup>/<sub>4</sub>"

**B:** 21 cm / 8 <sup>1</sup>/<sub>4</sub>"



**11-01-0743A**

Farabeuf Lambotte Bone Holding Forceps

**A:** 23 cm / 9" | **B:** 26 cm / 10"

Adjustable / with Ratchet

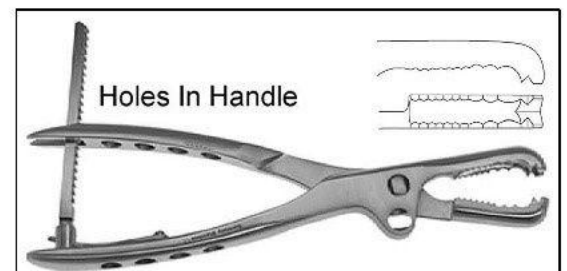

**11-01-0743B**



# AllWell Instruments co.

The name of Health Cure Instruments

BONE HOLDING FORCEPS

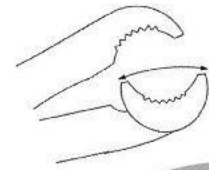

11-01-0744

Lambotte Bone Holding Forceps

w / Swivel Head, Adjustable Jaw

A: 22 cm | 8 3/4" | B: 27 cm | 10 3/4" | C: 30 cm | 11 3/4"



11-01-0745

Ulrich Bone Holding Forceps  
w / Thread Fixation 19 cm / 7 1/4"

# AllWell Instruments co.

11-01-0746

Ulrich Bone Holding Forceps

w / Thread Fixation

A: 23 cm / 9" | B: 25 cm / 9 3/4" | C: 28 cm / 11"

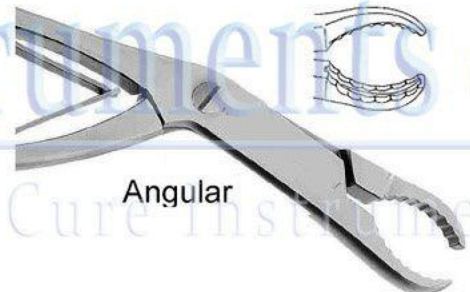

Angular

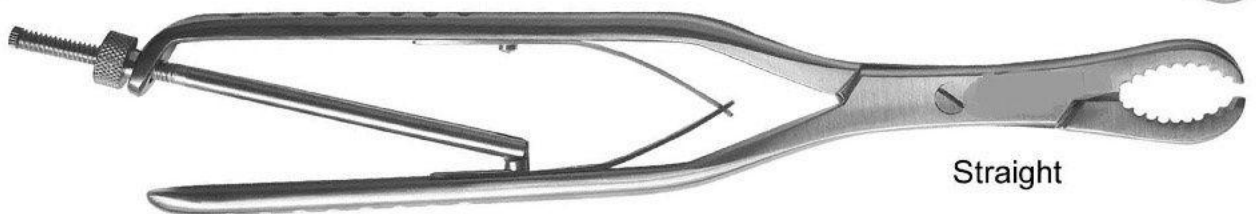

Straight





# AllWell Instruments co.

The name of Health Cure Instruments

BONE HOLDING FORCEPS



**11-01-0747**

Self-Centering Bone Holding Forceps  
W/ Thread Fixation

A: 15 cm / 6" | B: 19 cm / 17 1/2" | C: 24 cm / 9 1/2"  
D: 26 cm / 10 1/4" | E: 28 cm / 11"



**11-01-0748**

Lane Bone Holding Forceps w / Ratchet

A: 33 cm / 13"  
B: 45 cm / 17 3/4"

**11-01-0749**

Without Ratchet



# AllWell Instruments co.

The name of Health Cure Instruments

BONE HOLDING FORCEPS



**11-01-0750**

Hey Groves Bone Holding Forceps

A: 20 cm / 8" | B: 25 cm / 10" | C: 30 cm / 12"

The name of Health Cure Instruments



**11-01-0751**

Verbrugge Bone Holding Forceps

A: 17.5 cm / 7" | B: 25 cm / 9 3/4"

C: 26 cm / 10 1/4" | D: 27 cm / 10 3/4"

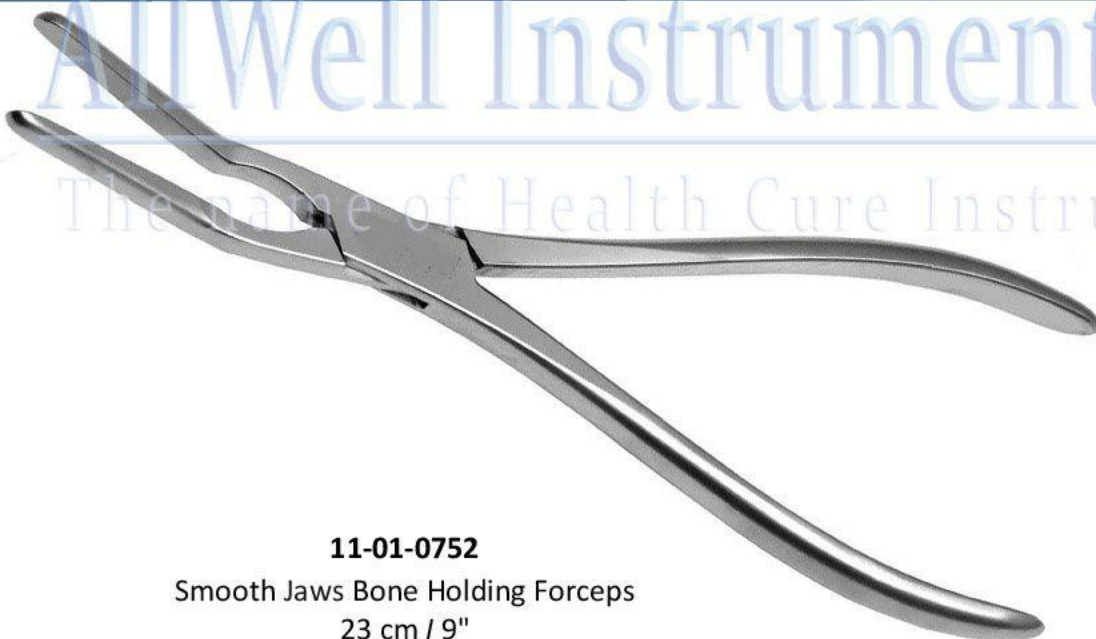

**11-01-0752**

Smooth Jaws Bone Holding Forceps

23 cm / 9"





# AllWell Instruments co.

The name of Health Cure Instruments

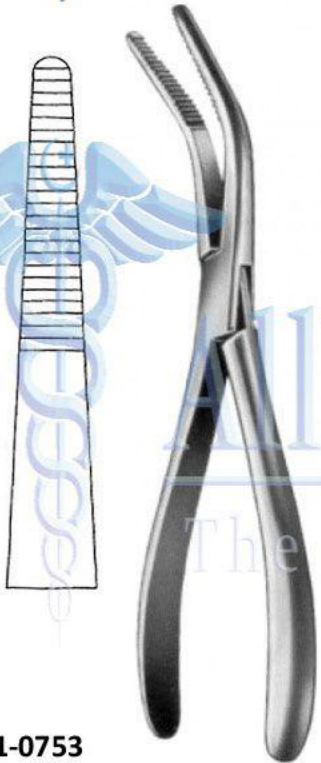

**11-01-0753**  
Van Buren Bone Holding Forceps  
21.5 cm / 8 1/2"

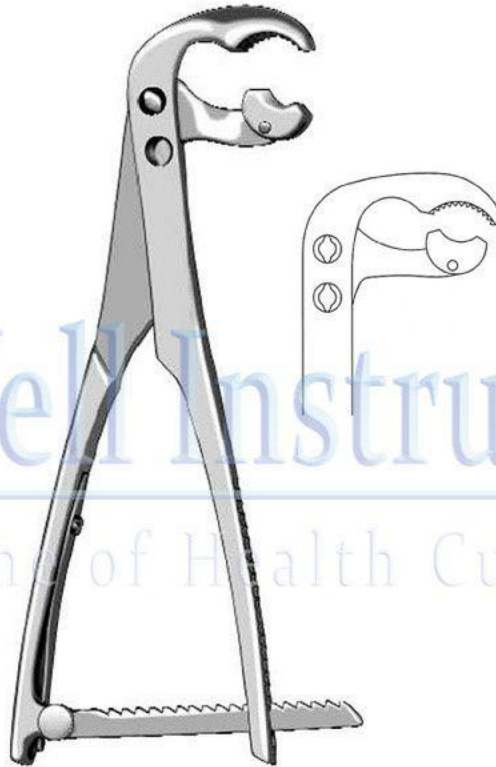

**11-01-0754**  
Angled Bone Holding Forceps 23 cm / 9"



**11-01-0755**  
Bishop Bone Holding Forceps 23 cm / 9"



**11-01-0756**  
Bone Holding Forceps  
A: 17cm 6 3/4" 0.9mm  
B: 13cm 5 1/4" 1.6mm

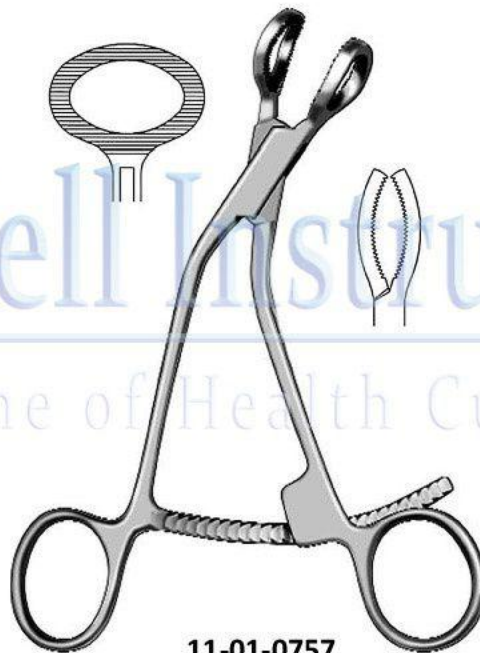

**11-01-0757**  
Bishop Bone Holding Forceps  
23 cm / 9"



**11-01-0758**  
Patella Forceps 18 cm / 7"



# AllWell Instruments co.

The name of Health Cure Instruments

BONE HOLDING FORCEPS



**11-01-0759**

Hayton Williams Forward Traction Forceps

Broad Tips 23 cm / 9"



**11-01-0760**

Fibula Bone Holding Forceps

21 cm / 8 1/2"



**11-01-0762-1**

Semb Bone Holding Forceps

Curved Sideward

21 cm / 8 1/2"

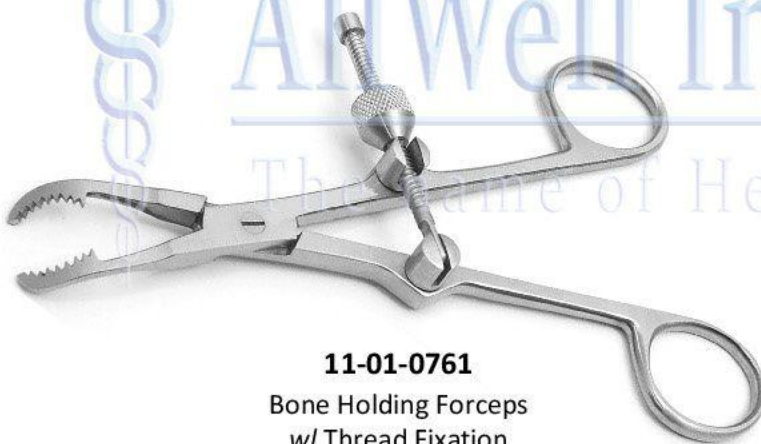

**11-01-0761**

Bone Holding Forceps

w/ Thread Fixation

15 cm / 6"





# AllWell Instruments co.

The name of Health Cure Instruments



Small

Large

**11-01-0762-2**

Bargo Bone Holding Forceps 15 cm / 6"



**11-01-0763**

Martin Cartilage Seizing Forceps  
18.5 cm / 7 1/4"



**11-01-0764**

Dingmann Cartilage Seizing Forceps  
18.5 cm / 7 1/4"



**11-01-0765**

Reposition Forceps  
13.5 cm / 5 1/4" Long ratchet pointed

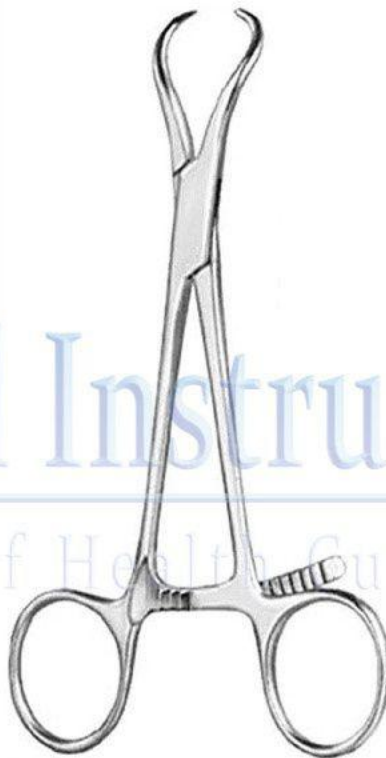

**11-01-0766**

Reposition Forceps  
15 cm / 6" Long Ratchet Pointed

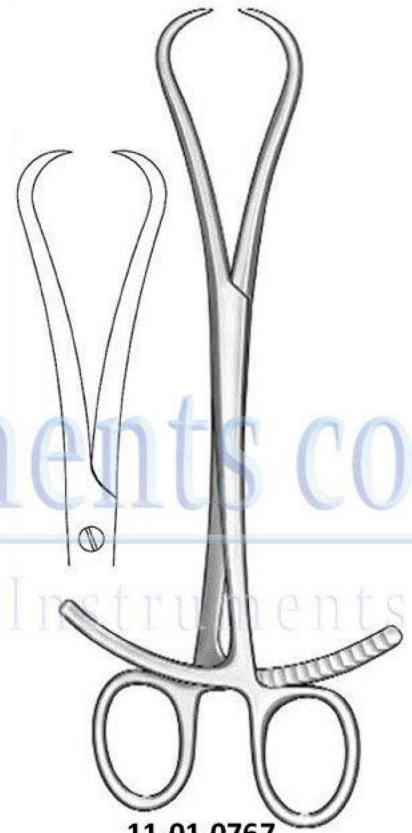

**11-01-0767**

Walton Bone Reduction Forceps  
20.5 cm / 8" | 2" Double Ratchet  
Opening 9-100mm



# AllWell Instruments co.

The name of Health Cure Instruments

REPOSITION – CARTILAGE FORCEPS

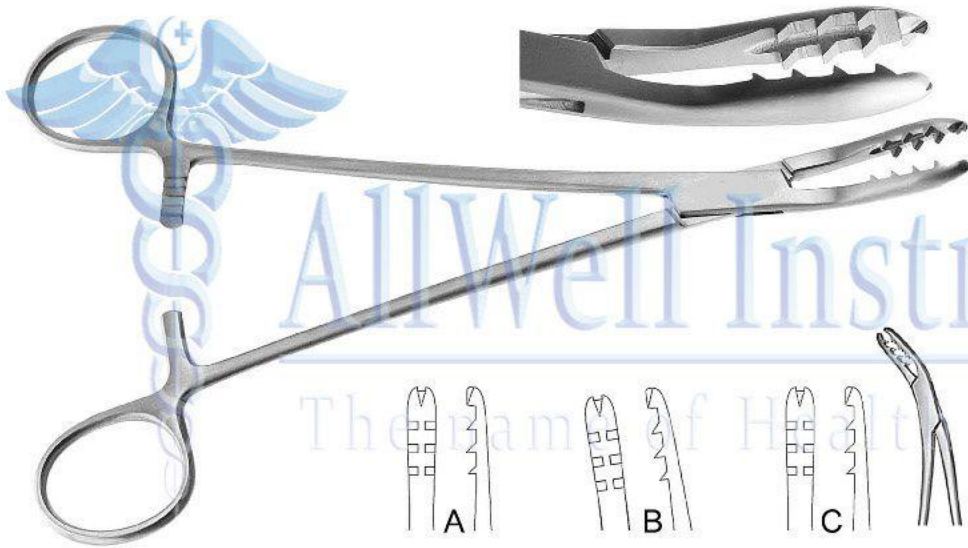

**11-01-0768**

Cartilage Seizing Forceps

A: Straight | B: Upward Cvd | C: Sideward Cvd

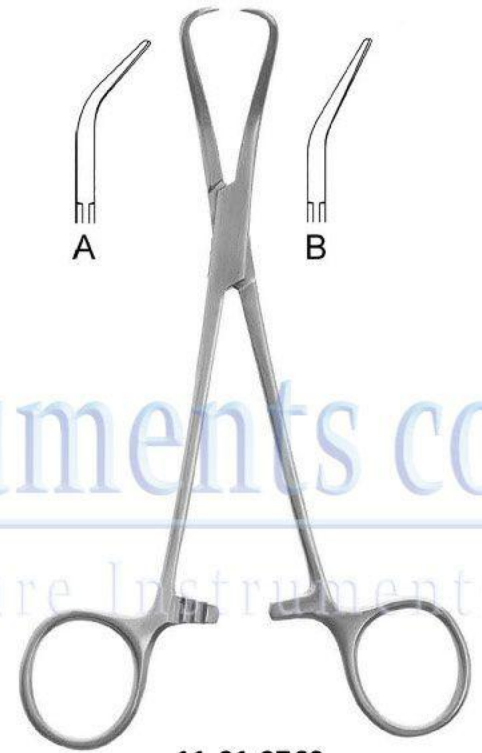

**11-01-0769**

Glenoid Perforating Forceps 17cm / 6 1/2"

A: Strong Cvd | B: Slight Cvd



**11-01-0770**

Bone Reposition Forceps  
w / Thread Fixations Screw

A: 17 cm / 6 3/4"

B: 24 cm / 9 1/2"



**11-01-0771**

Reill Bone Reduction Forcep

17.5 cm / 7"





# AllWell Instruments co.

The name of Health Cure Instruments

## BONE CUTTING FORCEPS



**11-01-0772**

Littauer Bone Cutting Forceps  
15 cm / 6"



**11-01-0773**

Marwalder Bone Nipper  
18.5 cm / 7 1/4"



**11-01-0774**

Cottle Kazanjian Bone Cutting  
Forceps 18.5 cm / 7 1/4"

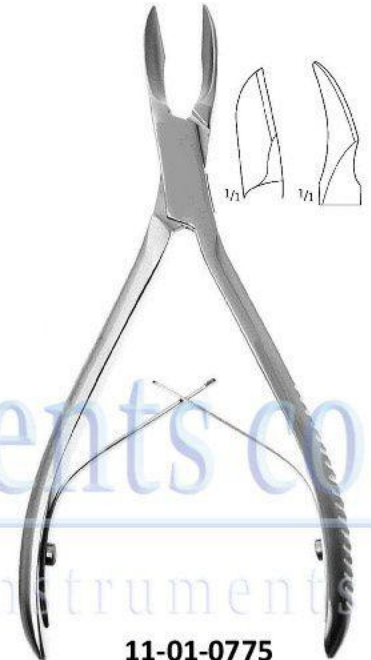

**11-01-0775**

Cleveland Bone Cutting Forceps  
A: 14.5 cm / 5 3/4"  
B: 17 cm / 6 3/4"



**11-01-0776**

Liston Bone Cutting Forceps

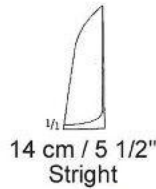

14 cm / 5 1/2"  
Straight



14 cm / 5 1/2"  
Curved

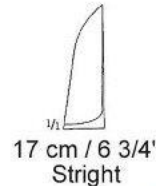

17 cm / 6 3/4"  
Straight



17 cm / 6 3/4"  
Curved



20 cm / 8"  
Straight



20 cm / 8"  
Curved



22 cm / 8 3/4"  
Straight



22 cm / 8 3/4"  
Curved



# AllWell Instruments co.

The name of Health Cure Instruments

BONE CUTTING FORCEPS

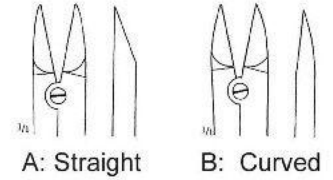

11-01-0777

Kleinert-Kutz / Bohler Bone Cutting  
Forceps 14.5 cm / 5 3/4"

AllWell Instruments co.

The name of Health Cure Instruments

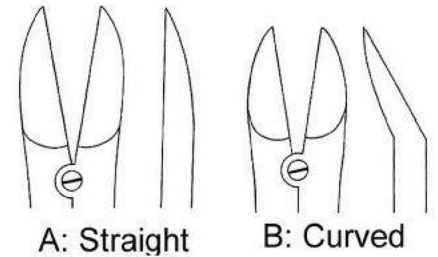

11-01-0778

Ruskin Liston Bone Cutting Forceps  
18 cm / 7"

AllWell Instruments co.

The name of Health Cure Instruments

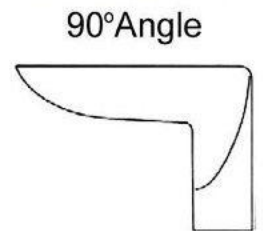

11-01-0779

Stille-Liston Bone Cutting Forceps  
26 cm / 10 1/4"





# AllWell Instruments co.

The name of Health Cure Instruments

## BONE CUTTING FORCEPS

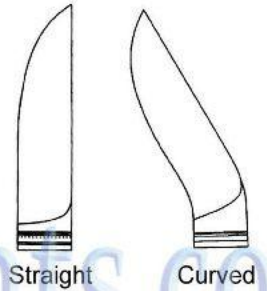

**11-01-0780**

Stille-Liston Bone Cutting Forceps  
A: 23 cm / 9" | B: 27.5 cm / 10 3/4"



**11-01-0781**

Cleveland Bone Cutting Forceps  
16 cm / 6 1/4"

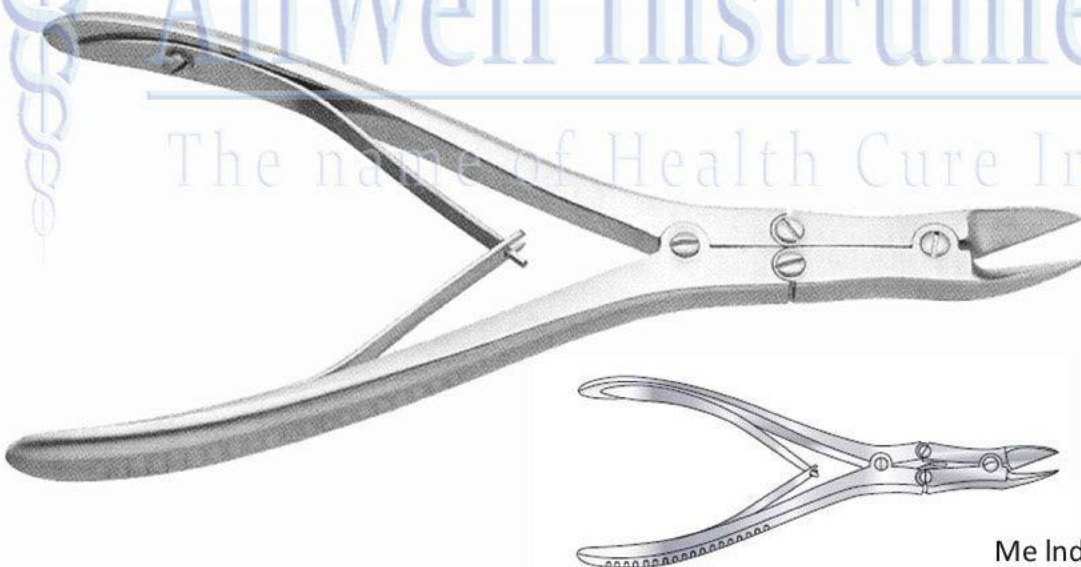

**11-01-0782**

Me Indoe Bone Cutting Forceps  
18 cm / 7" Delicate Blades



# AllWell Instruments co.

The name of Health Cure Instruments

BONE CUTTING FORCEPS

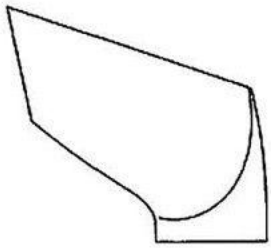

45° Angled

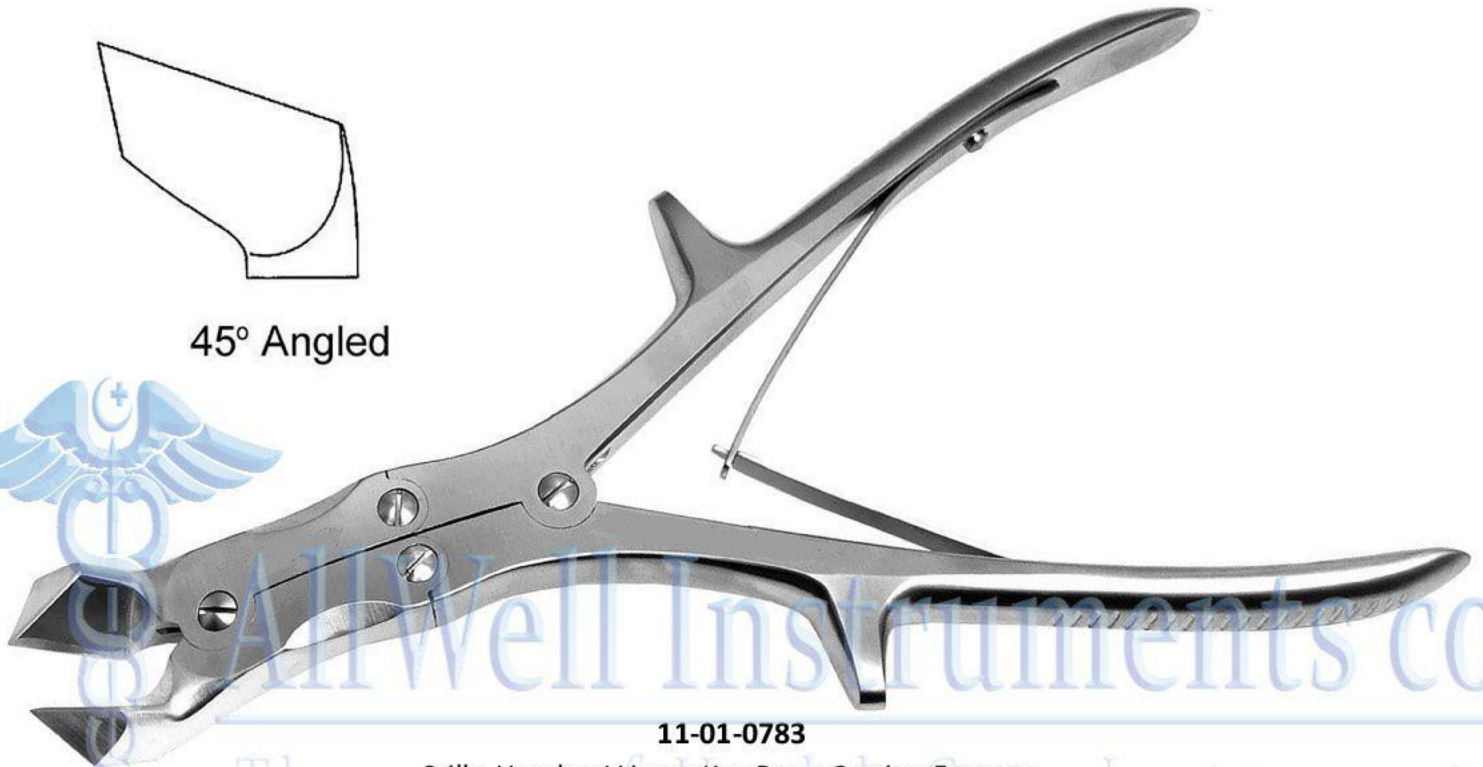

**11-01-0783**

Stille-Horsley / Liston Key Bone Cutting Forceps  
25.5 cm / 10"

The name of Health Cure Instruments

90° Angled



Angled On Side

**11-01-0784**

Semb Bone Cutting Forceps  
24.5 cm / 9 3/4"

The name of Health Cure Instruments





# AllWell Instruments co.

The name of Health Cure Instruments

BONGE RONGEURS - NIBBLERS

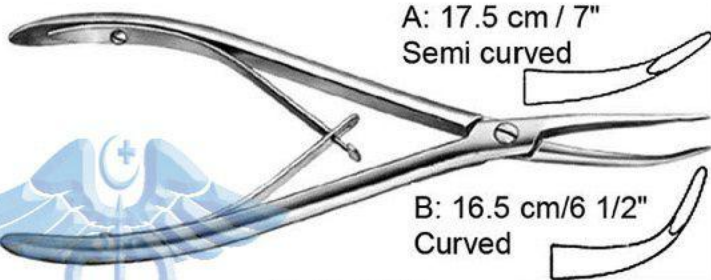

**11-01-0785**  
Stellbrink Bone Rongeur

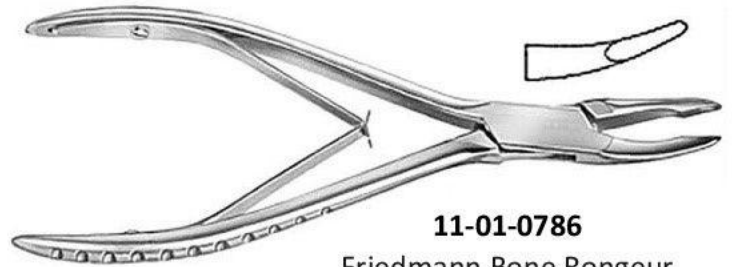

**11-01-0786**  
Friedmann Bone Rongeur  
A: 12.5 cm / 5" | B: 13.5 cm / 5 1/4"



**11-01-0787**  
Friedmann Bone Rongeur  
13.5 cm / 5 1/4"



**11-01-0788**  
Cleveland Bone Rongeur  
A: 13.5 cm / 5 1/4" | B: 16.5 cm / 6 1/2"



**11-01-0789**  
Mead Bone Rongeur 16.5 cm / 6 1/2"

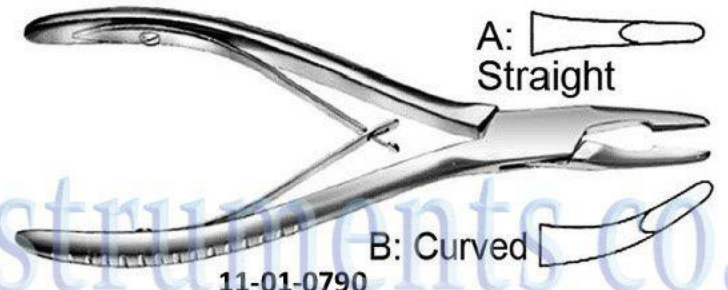

**11-01-0790**  
Jansen Bone Rongeur 18 cm / 7"

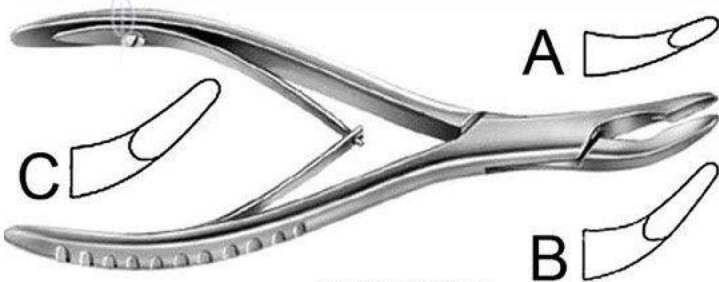

**11-01-0791-1**  
Luer Bone Rongeur 14.5 cm / 5 3/4"

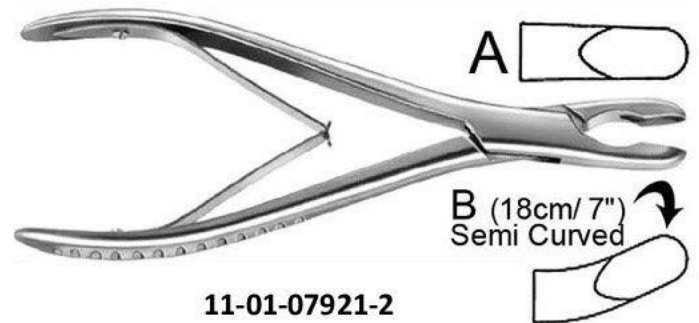

**11-01-07921-2**  
Luer Bone Rongeur 18.5 cm / 7 1/4"





# AllWell Instruments co.

The name of Health Cure Instruments

BONGE RONGEURS - NIBBLERS

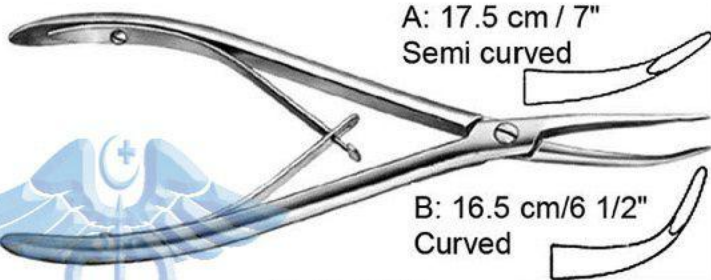

**11-01-0785**  
Stellbrink Bone Rongeur

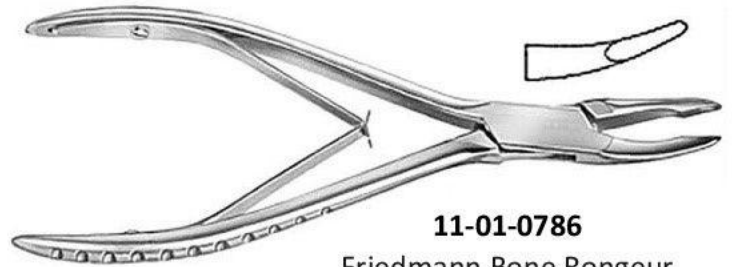

**11-01-0786**  
Friedmann Bone Rongeur  
A: 12.5 cm / 5" | B: 13.5 cm / 5 1/4"



**11-01-0787**  
Friedmann Bone Rongeur  
13.5 cm / 5 1/4"



**11-01-0788**  
Cleveland Bone Rongeur  
A: 13.5 cm / 5 1/4" | B: 16.5 cm / 6 1/2"



**11-01-0789**  
Mead Bone Rongeur 16.5 cm / 6 1/2"

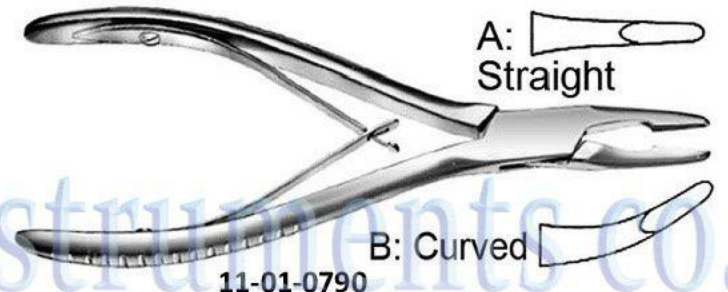

**11-01-0790**  
Jansen Bone Rongeur 18 cm / 7"

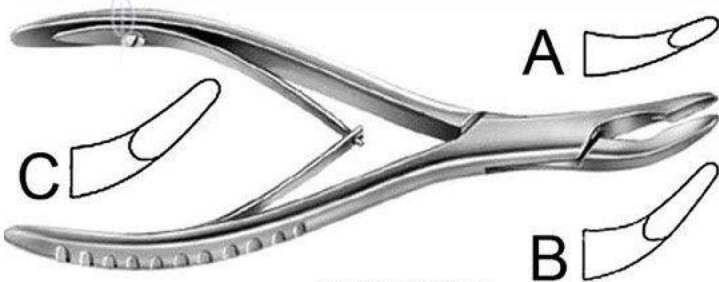

**11-01-0791-1**  
Luer Bone Rongeur 14.5 cm / 5 3/4"

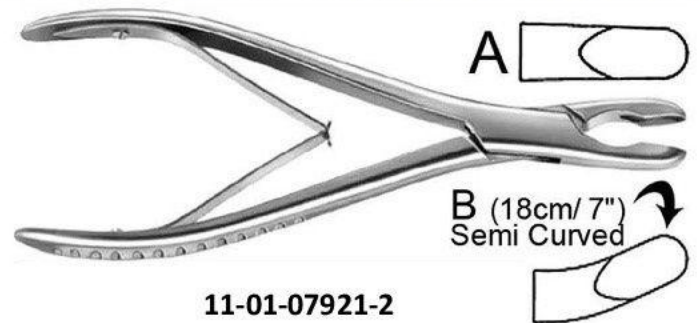

**11-01-07921-2**  
Luer Bone Rongeur 18.5 cm / 7 1/4"





# AllWell Instruments co.

The name of Health Cure Instruments

BONGE RONGEURS - NIBBLERS

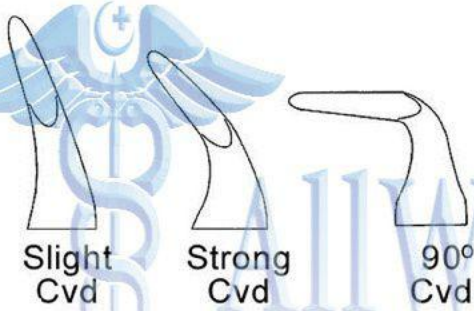

Slight  
Cvd

Strong  
Cvd

90°  
Cvd



11-01-0792

Bluemental Bone Rongeur 12.5 cm / 5"



5mm

11-01-0793

Hartmann Bone Rongeur 17.5 cm / 7"

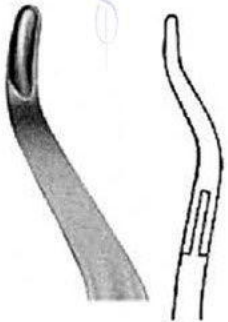

4mm



11-01-0794

Jansen Bone Rongeur 19 cm / 7 1/2" Bayonet



# AllWell Instruments co.

The name of Health Cure Instruments

BONGE RONGEURS - NIBBLERS



**11-01-0795**

Jansen Bone Rongeur Straight

A: 14 cm / 5 1/2"

B: 17 cm / 6 1/2"



**11-01-0796**

Jansen Bone Rongeur Delicate

14 cm / 5 1/2"



**11-01-0797**

Bohler Bone Rongeur 15.5 cm / 6"



**11-01-0798**

Beyer Bone Rongeur 18 cm / 7"



**11-01-0799**

Zaufai-Jansen Bone Rongeur 18 cm / 7"



**11-01-0800**

Mayfield Bone Rongeur 18 cm / 7"



**11-01-0801**

Marquard Bone Rongeur 20.5 cm / 8"



**11-01-0802**

Lempert Bone Rongeur 19 cm / 7 1/2"





# AllWell Instruments co.

The name of Health Cure Instruments

BONGE RONGEURS - NIBBLERS



11-01-0803

Stille Bone Rongeur

22.5 cm / 8 3/4"

AllWell Instruments co.

The name of Health Cure Instruments

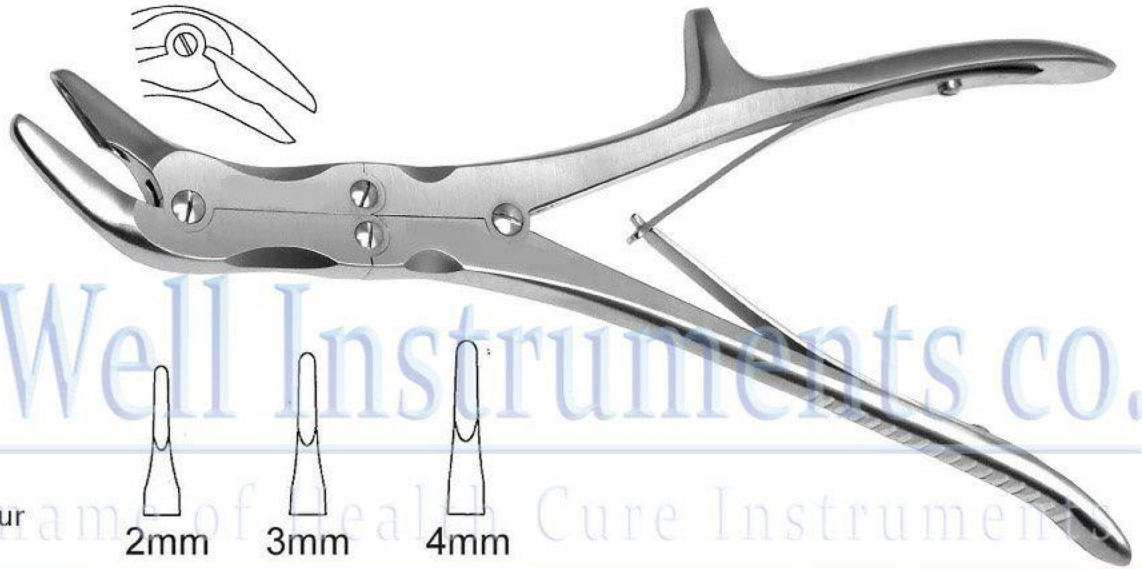

11-01-0804

Echlin Duckbill Bone Rongeur

22 cm / 8 3/4"

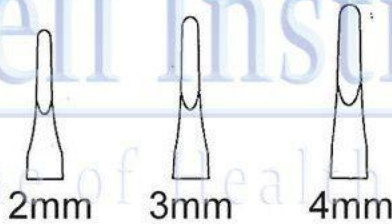

AllWell Instruments co.

The name of Health Cure Instruments



11-01-0805

Ruskin Bone Rongeur

18 cm / 7"





# AllWell Instruments co.

The name of Health Cure Instruments

BONGE RONGEURS - NIBBLERS

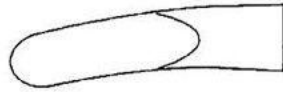

**11-01-0805**

Ruskin Bone Rongeur  
24 cm / 9 1/2"

AllWell Instruments co.

The name of Health Cure Instruments

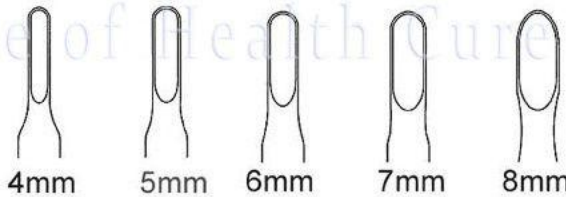

**11-01-0806**

Leksell Stille Bone Rongeur  
24 cm / 9 1/2"

AllWell Instruments co.

The name of Health Cure Instruments

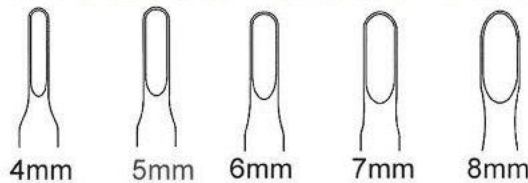

**11-01-0807**

Leksell Bone Rongeur  
24 cm / 9 1/2"

AllWell Instruments co.

The name of Health Cure Instruments

AllWell Instruments co.

The name of Health Cure Instruments





# AllWell Instruments co.

The name of Health Cure Instruments

BONGE RONGEURS - NIBBLERS



**11-01-0808**

Leksell Bone Rongeur  
23 cm / 9"

- A: Straight
- B: Slight Curved
- C: Strong Curved
- D: Extra Strong Cvd

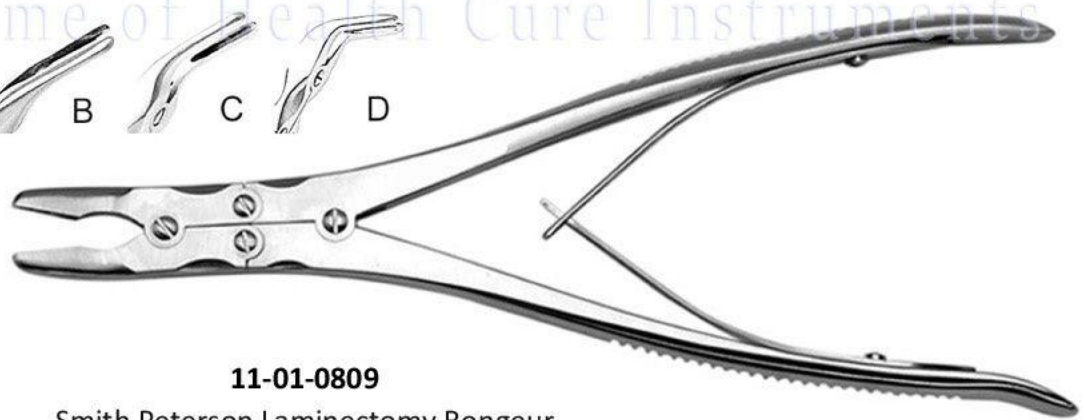

**11-01-0809**

Smith Peterson Laminectomy Rongeur  
24 cm / 9 1/2"

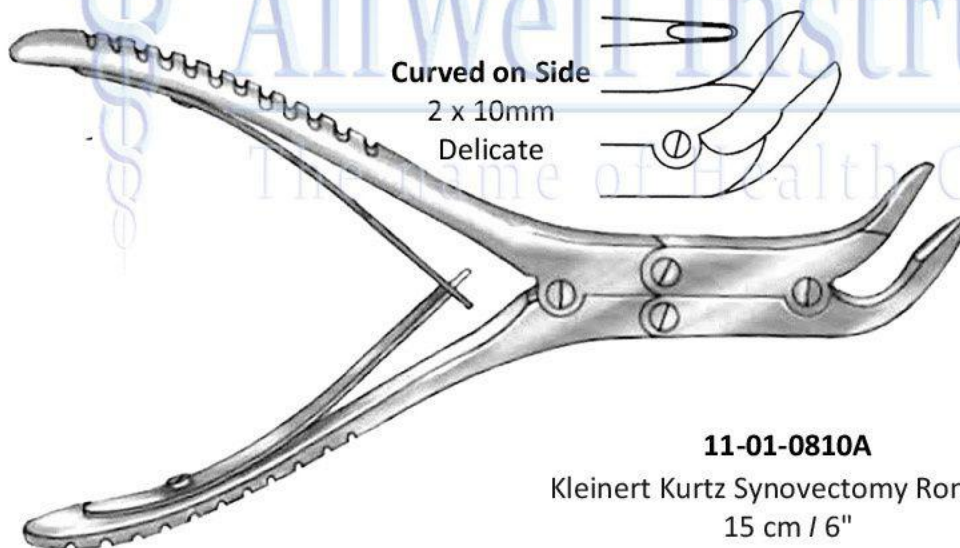

Curved on Side  
2 x 10mm  
Delicate

**11-01-0810A**

Kleinert Kurtz Synovectomy Rongeur  
15 cm / 6"



# AllWell Instruments co.

The name of Health Cure Instruments

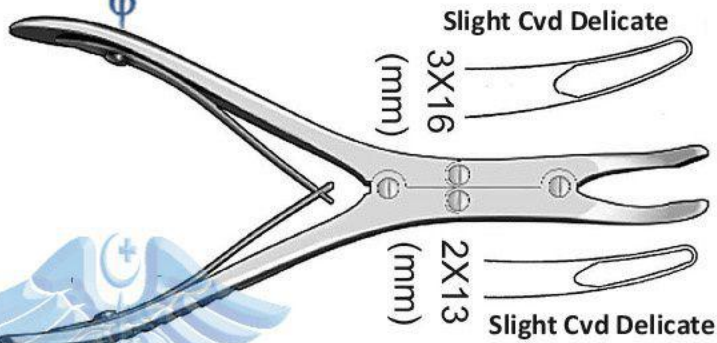

Slight Cvd Delicate

3X16  
(mm)

2X13  
(mm)

Slight Cvd Delicate

**11-01-0810B**

Kleinert Kurtz Synovectomy Rongeur 15 cm / 6"

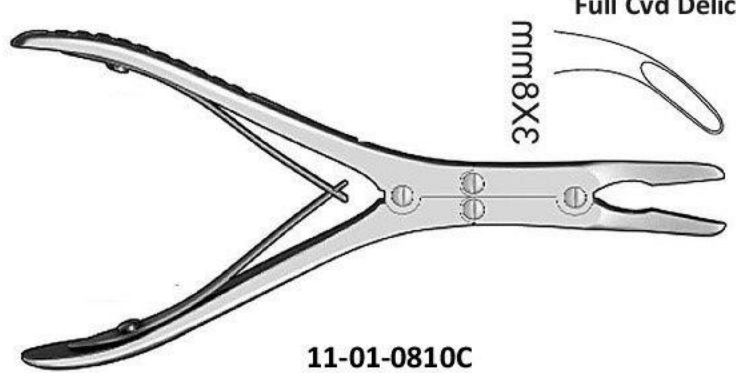

Full Cvd Delicate

3mmX8mm

**11-01-0810C**

Kleinert Kurtz Synovectomy Rongeur 15 cm / 6"

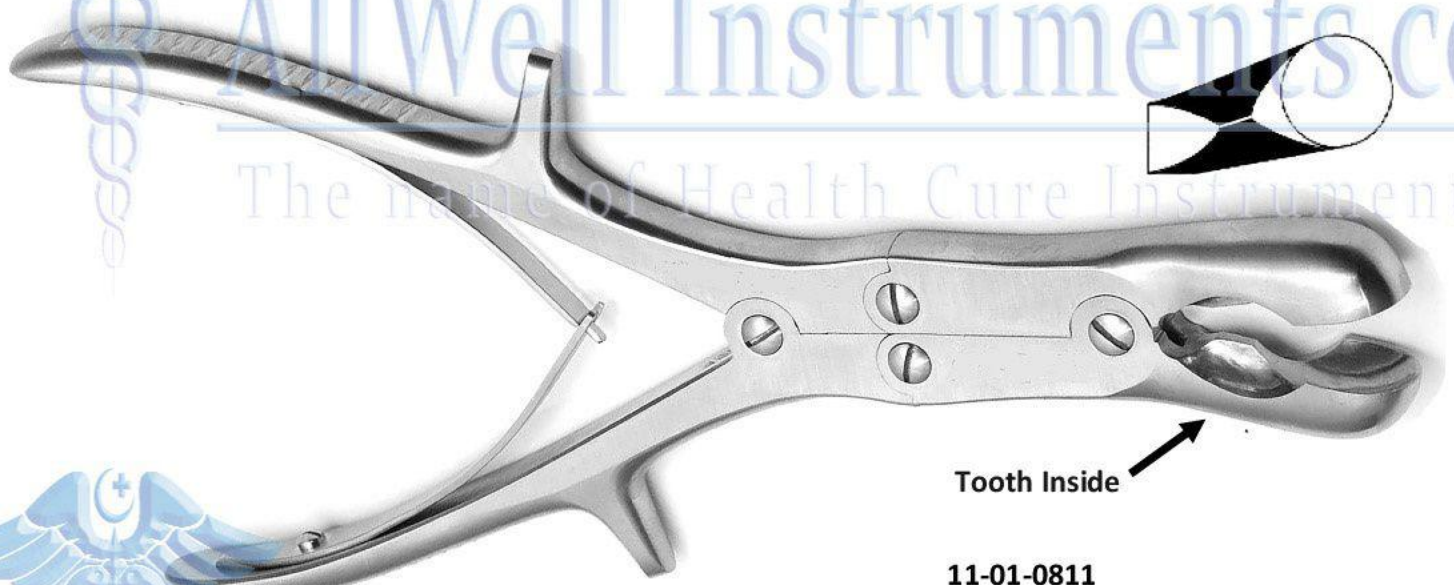

Tooth Inside

**11-01-0811**

Semb Bone Rongeur 23.5 cm / 9 1/4"



8mm

**11-01-0812**

Stille Ruskin Bone Rongeur  
23.5 cm / 9 1/4"





# AllWell Instruments co.

The name of Health Cure Instruments

BONGE RONGEURS - NIBBLERS

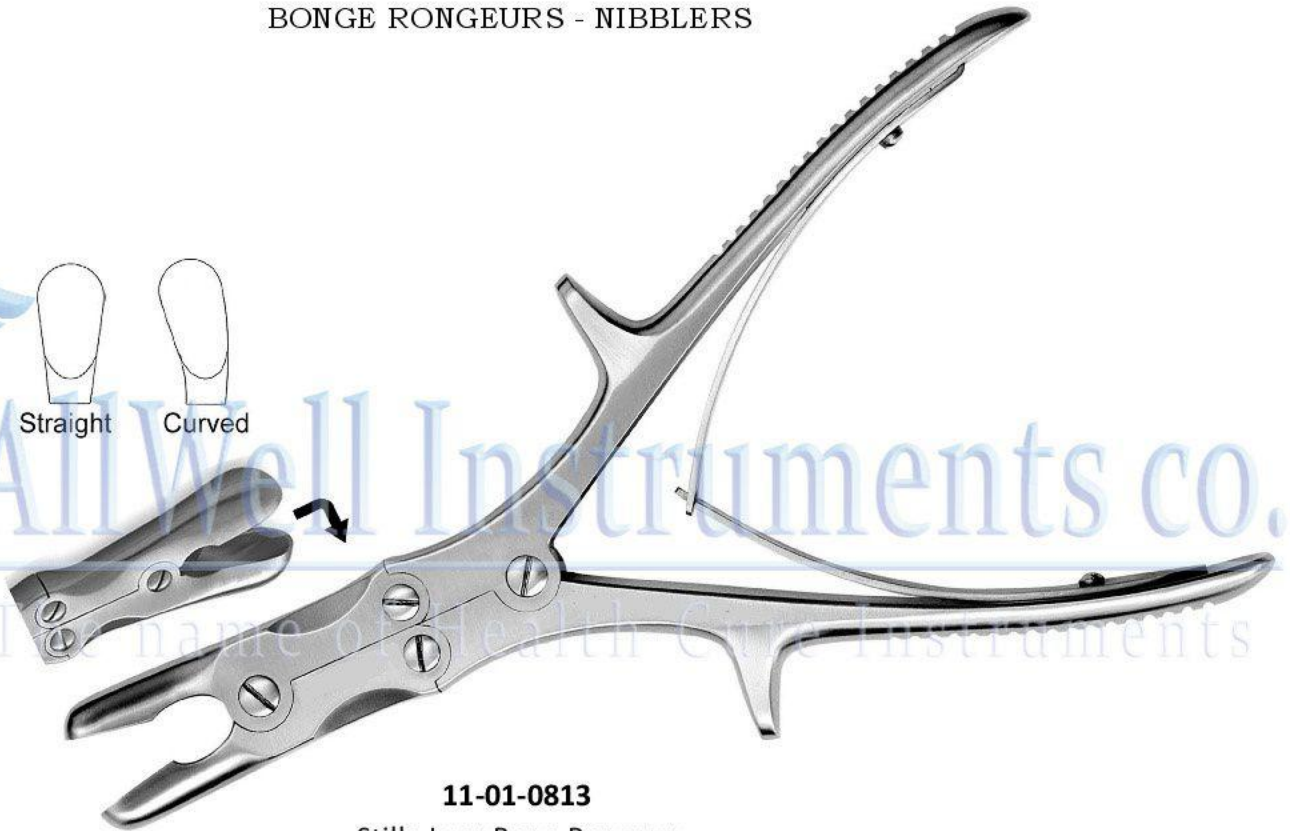
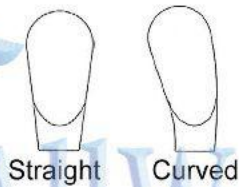

**11-01-0813**

Stille Luer Bone Rongeur  
26.5 cm / 10 1/2"

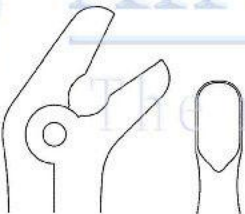

Also Available in  
Angled On Side

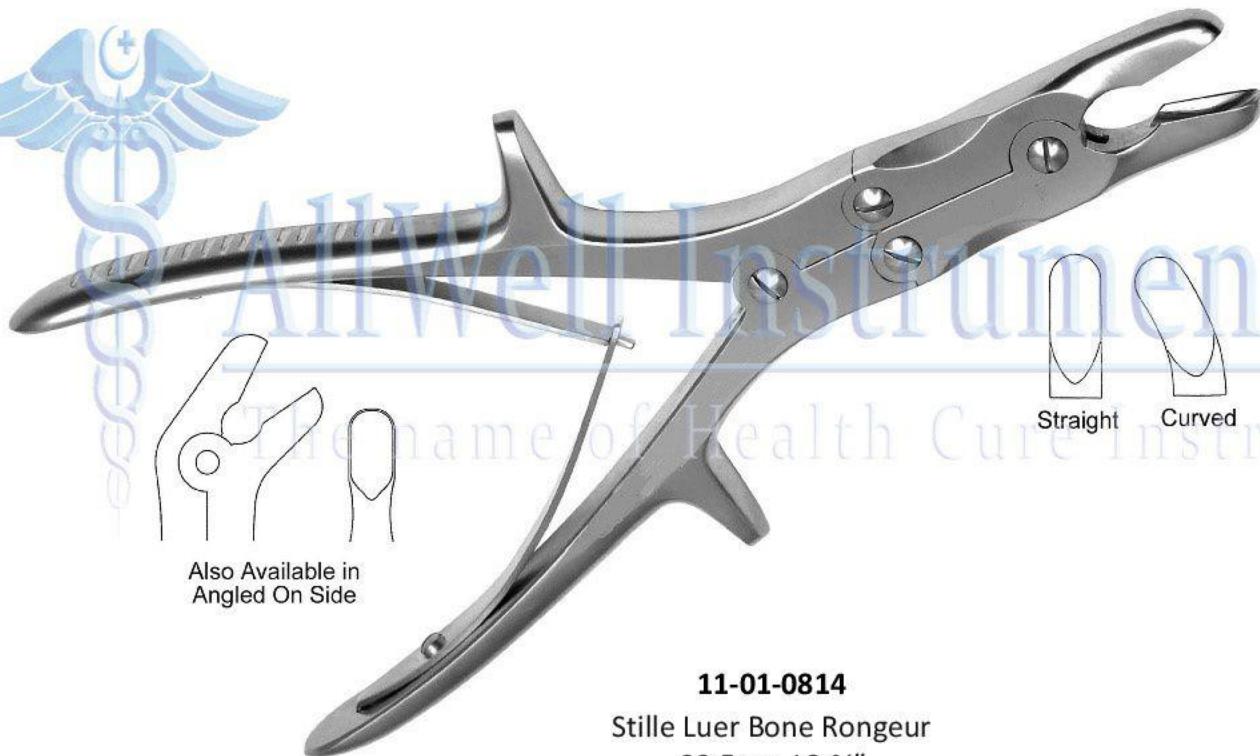
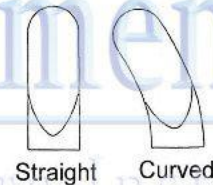

**11-01-0814**

Stille Luer Bone Rongeur  
22.5 cm / 8 3/4"



# AllWell Instruments co.

The name of Health Cure Instruments



**11-01-0815**

Mainz Long Neck Bone Rongeur  
18 cm / 7"



A: 3mm  
B: 5mm  
C: 8mm

**11-01-0816**

Leksell Bayonet Rongeur  
41 cm / 16"

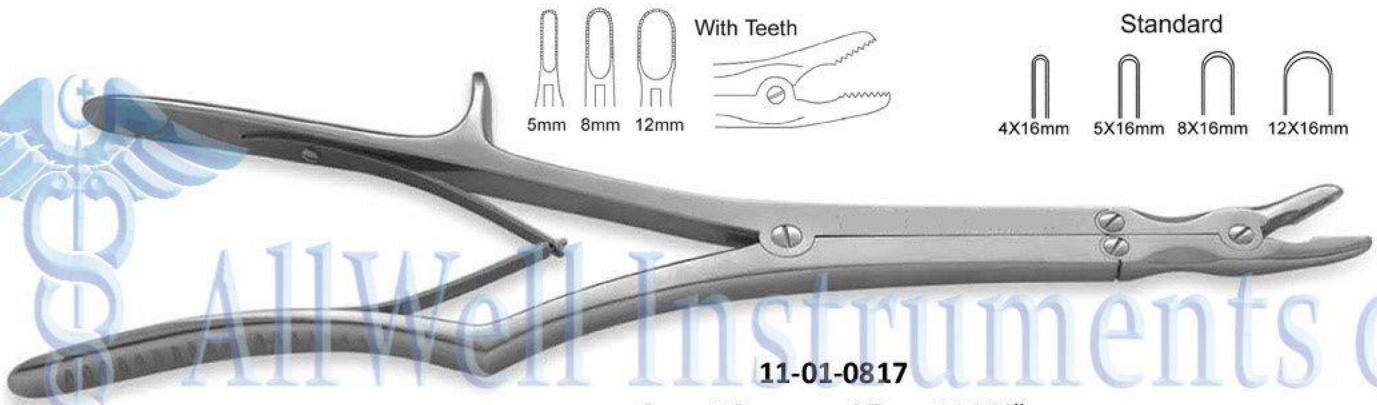

**11-01-0817**

Syfert Rongeur 37 cm / 14 1/2"

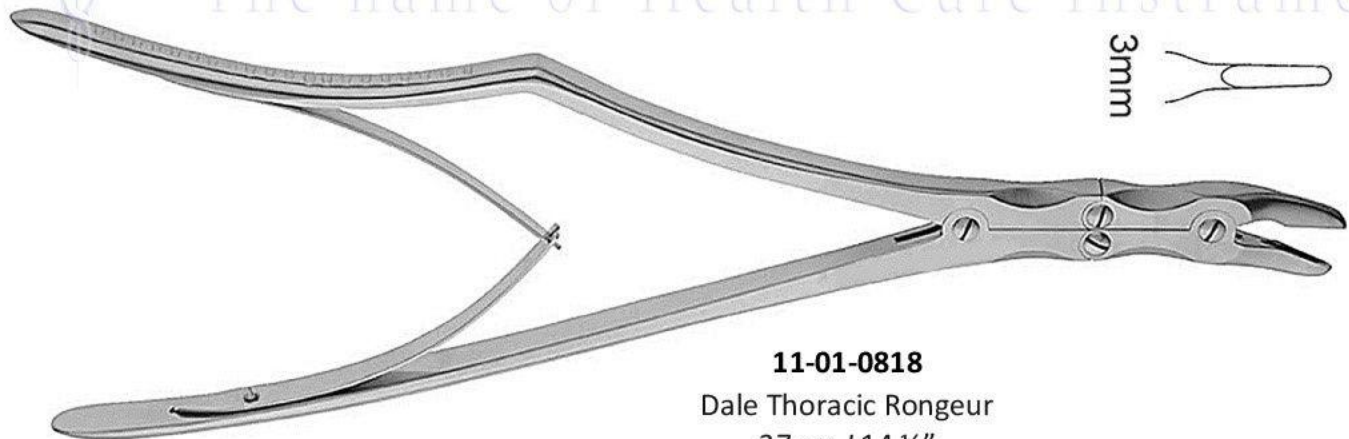

**11-01-0818**

Dale Thoracic Rongeur  
37 cm / 14 1/2"





# AllWell Instruments co.

The name of Health Cure Instruments

BONGE RONGEURS - NIBBLERS

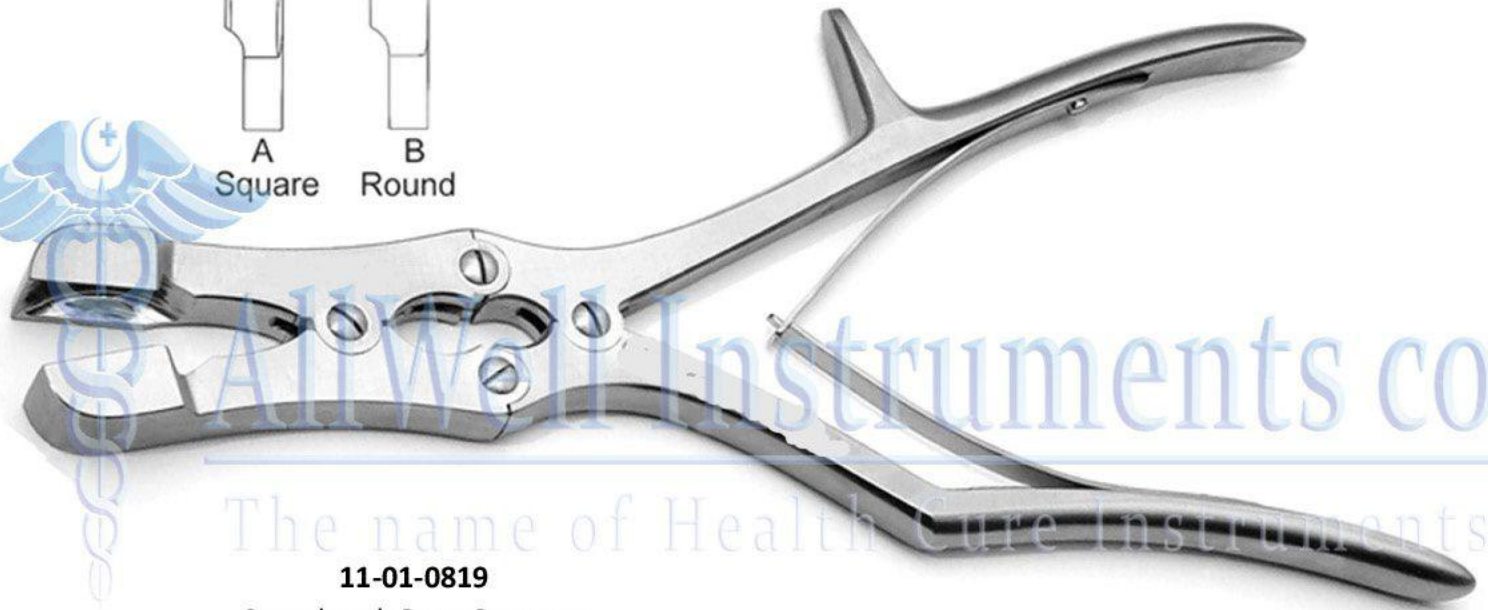
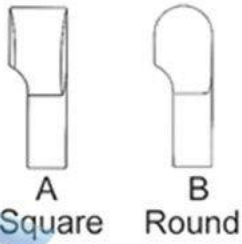

**11-01-0819**

Sauerbruch Bone Rongeur

37 cm / 14 1/2"



**11-01-0820**

Brunner Rib Shear

28 cm / 11"



**11-01-0821**

Sauerbruch Rib Shear

A: 23 cm / 9" | B: 26 cm / 10 1/4"



# AllWell Instruments co.

The name of Health Cure Instruments

RIB SHEARS



**11-01-0822**  
Giertz Stille Rib Shear  
25 cm / 10"



**11-01-0823**  
Rib Shear Double Spring 22 cm / 8 3/4"



A: 20 cm / 8"  
B: 23 cm / 9"  
**11-01-0824**  
Rib Shear Double Spring



**11-01-0825**  
Collin Rib Shear 17.5 cm / 7"



**11-01-0826**  
Collin Rib Shear 17 cm / 6 3/4"



**11-01-0828**  
Gluck Rib Shear

- A: 16 cm / 6"
- B: 18 cm / 7"
- C: 20 cm / 8"
- D: 23 cm / 9"



**11-01-0827**  
Stille Rib Shear 21 cm / 8 1/4"





# AllWell Instruments co.

The name of Health Cure Instruments

RIB SHEARS



**11-01-0829**

Labsche Rib Shear 25 cm / 10"



**11-01-0830**

T Handle Labsehe Sternum Chisel  
24 cm / 9 1/2"



**11-01-0831**

Rib Shear Sideward 17 cm / 6 3/4"

Pointed  
Tips



**11-01-0832B**

Bethune Rib Shear  
S Shaped Handle  
34 cm / 13 1/2"



**11-01-0832A**

Bethune Rib Shear  
S Shaped Handle  
34 cm / 13 1/2"



# AllWell Instruments co.

The name of Health Cure Instruments

RIB SHEARS



AllWell Instruments co.

The name of Health Cure Instruments

**11-01-0833**

Coryllos-Bethune Rib Shear  
S Shaped Handle  
35 cm | 13 1/2"

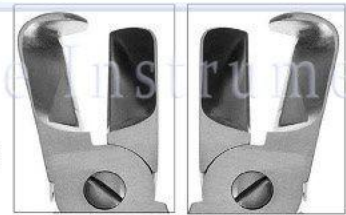

Left

Right



AllWell Instruments co.

The name of Health Cure Instruments



**11-01-0834**

Roos Rib Shear  
Right Angled Jaw W/ Hook  
33 cm / 13"





# AllWell Instruments co.

The name of Health Cure Instruments

LAMINA SPREADERS - RETRACTORS

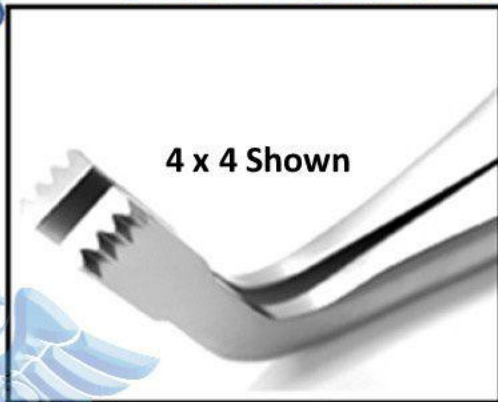

4 x 4 Shown



11-01-0835

INGE Spreader / Retractor

AllWell Instruments co.

The name of Health Cure Instruments

Available in 4X4 and 6X6 Teeth & Without Teeth (Plain)

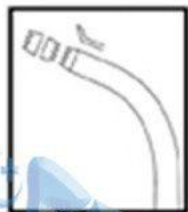
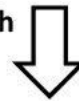

A: 4X4 Teeth  
B: Without Teeth  
16.5 cm / 6 1/2"

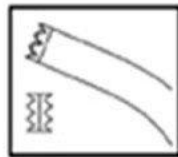

C: 4X4 Teeth  
D: Without Teeth  
25.5 cm / 10"

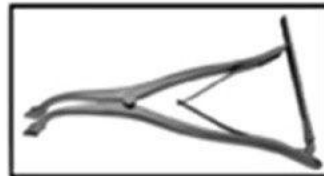

10 Inch Length Pattern

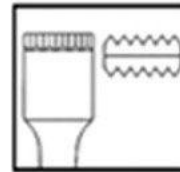

A: 6X6 Teeth  
B: Without Teeth  
27 cm / 10 1/2"  
Flat Blades

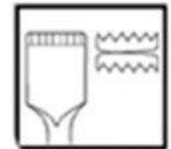

C: 6X6 Teeth  
D: Without Teeth  
27 cm / 10 1/2"  
Concave Blades

AllWell Instruments co.

The name of Health Cure Instruments



11-01-0836-1

Offset Lamina Spreader / Retractor  
25.5 cm / 10"



# AllWell Instruments co.

The name of Health Cure Instruments

LAMINA SPREADERS - RETRACTORS

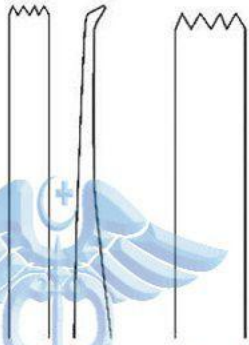

**11-01-0836-2**

Vertibra Spreader / Retractor  
A: 18 cm / 7" | B: 28 cm / 11"



**11-01-0837**

Inge Spreader  
Serrated Outside Blades 18 cm / 7"



**11-01-0838**

Saxsena Lamina Spreader / Retractor  
A: 18 cm / 7" | B: 25.5 cm / 10"  
Serrated Outside Blades

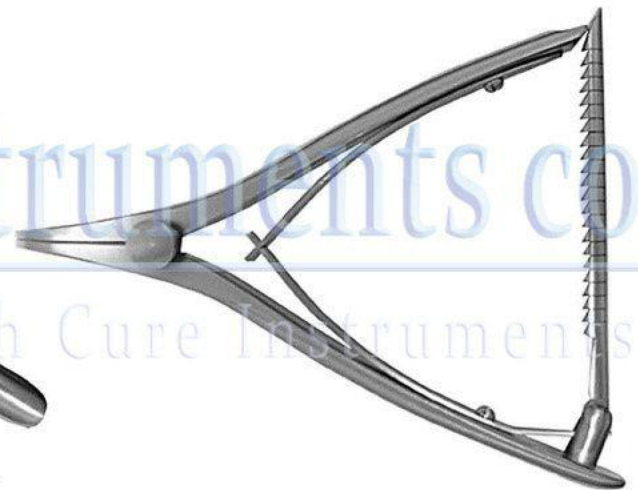





# AllWell Instruments co.

The name of Health Cure Instruments

CALCANEAL - LAMBARDI SPREADERS



**11-01-0839**  
Calcaneal Spreader  
Smooth Pads 15X12mm  
18 cm / 7"



**11-01-0840**  
Calcaneal Spreader  
Grooved Pads 15X12mm  
18 cm / 7"



**11-01-0841**  
Lombardi Femoral Tibial Spreader (Small)  
A: Grooved Pads 22X13mm 18 cm / 7"  
B: Diamond Cut Pads 22x13mm / 7"



B: Diamond Cut Pads 22X13mm

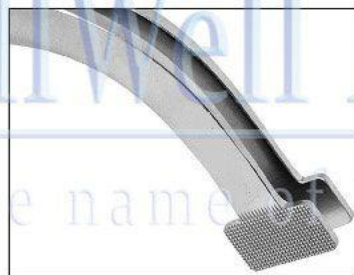

B: Diamond Cut Pads 22X13mm



**11-01-0842**  
Lombardi Femoral Tibial Spreader (Large)  
A: Grooved Pads 22X13mm 23.5 cm / 9 1/4"  
B: Diamond Cut Pads 22x13mm / 9 1/4"



# AllWell Instruments co.

The name of Health Cure Instruments

COMPRESSORS - DISTRACTORS



**11-01-0843**

Distracting Forceps 23 cm / 9"  
Long Ratchet / Spiral Pring  
For Screws and Rods



**11-01-0844**

Compressing Forceps 28 cm / 11"  
Adjustable Locking  
For Screws and Rods



**11-01-0845**

Distracting Forceps 25.5 cm / 10"  
Leaf Pring | For Screws and Rods



AllWell Instruments co.

The name of Health Cure Instruments





# AllWell Instruments co.

The name of Health Cure Instruments

COMPRESSORS - DISTRACTORS

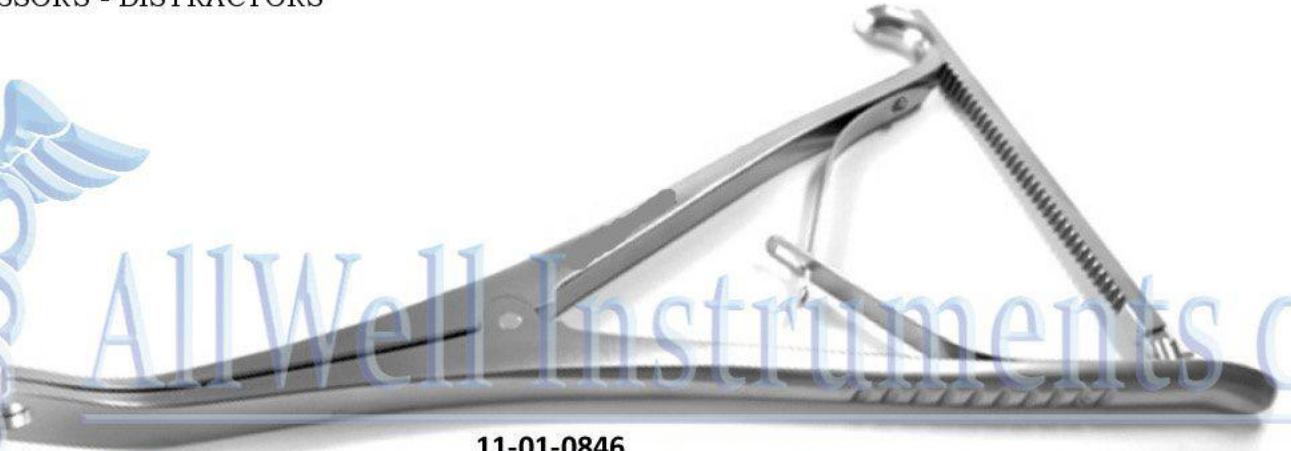

**11-01-0846**

Distractor 25.5 cm / 10"  
Leaf Pring | For Screws and Rods



**11-01-0847**

Compression Forceps  
28 cm / 11"  
Leaf Pring / Long Ratchet  
For Screws and Rods

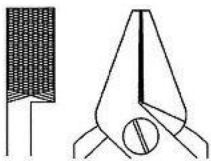

Non TC



**11-01-0848**

Jet Wire Twisting Device  
28 cm / 11" - 10mm Tip

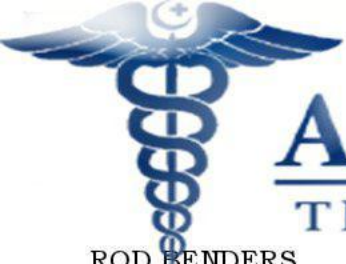

# AllWell Instruments co.

The name of Health Cure Instruments

ROD BENDERS

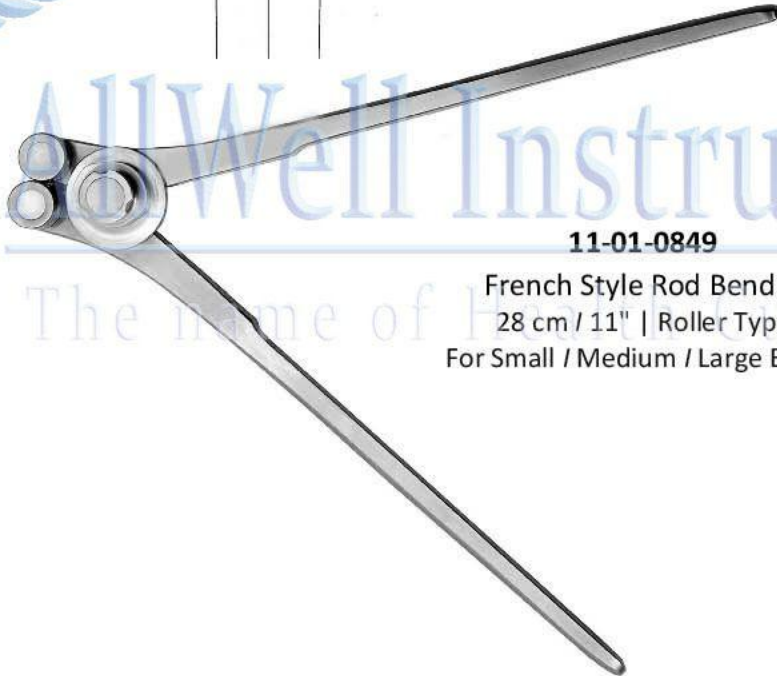
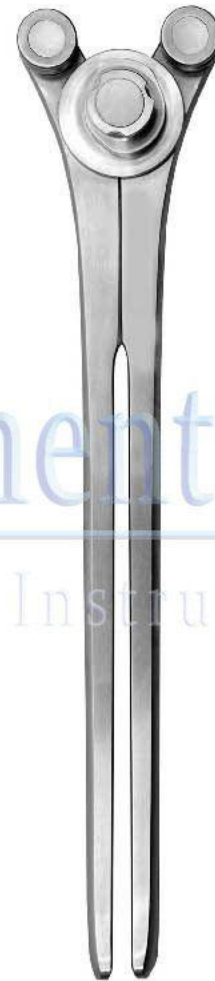
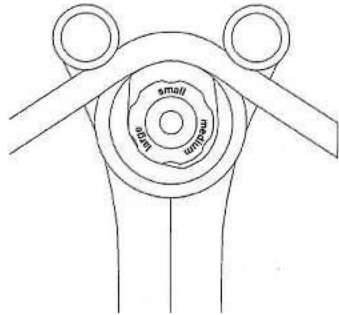

**11-01-0849**

French Style Rod Bender  
28 cm / 11" | Roller Type  
For Small / Medium / Large Bends



AllWell Instruments co.

The name of Health Cure Instruments



AllWell Instruments co.

The name of Health Cure Instruments

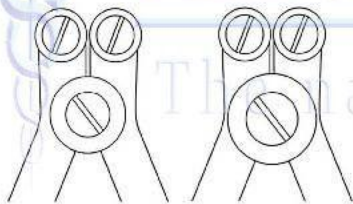

For 4mm Rod    For 3mm Rod



**11-01-0850**

One Hand Rod Bender | 19 cm / 7"  
For 3 and 4 mm Diameter Rod





# AllWell Instruments co.

The name of Health Cure Instruments

CARBIDE INSERTED WIRE - PIN CUTTING PLIERS

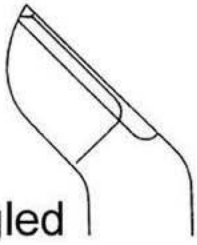

Angled

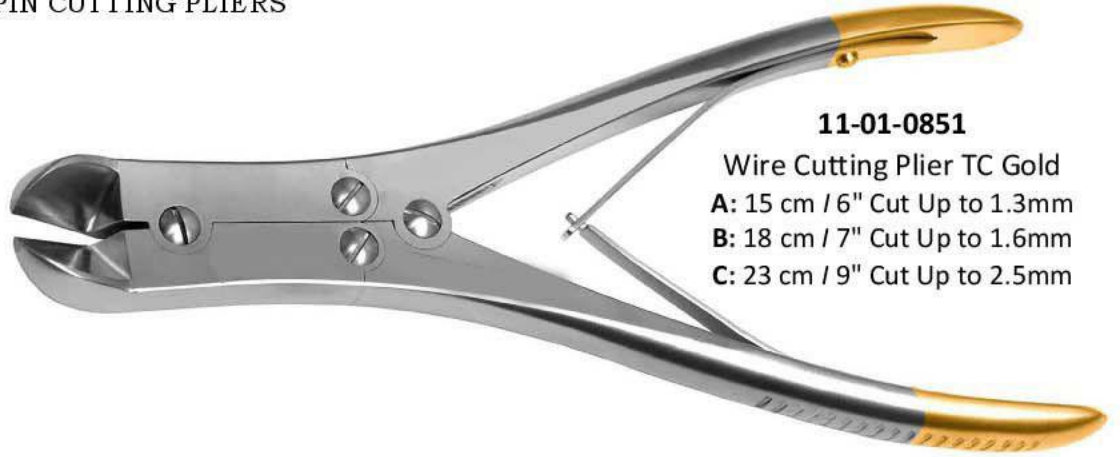

**11-01-0851**

Wire Cutting Plier TC Gold  
A: 15 cm / 6" Cut Up to 1.3mm  
B: 18 cm / 7" Cut Up to 1.6mm  
C: 23 cm / 9" Cut Up to 2.5mm



**11-01-0852**

Wire Cutting Plier TC Gold  
A: 15 cm / 6" Cut Up to 1.3mm  
B: 18 cm / 7" Cut Up to 1.6mm



**11-01-0853**

Wire Cutting Plier TC Gold  
23 cm / 9" Cut Up to 2.5mm



**11-01-0854**

Wire Cutting Plier TC Gold  
18 cm / 7" Cut Up to 1.6mm



# AllWell Instruments co.

The name of Health Cure Instruments

CARBIDE INSERTED WIRE - PIN CUTTING PLIERS



**11-01-0859**  
Plate / Pin Cutting Plier  
TC Gold | 23 cm / 9"  
Cut Up to 3.0mm

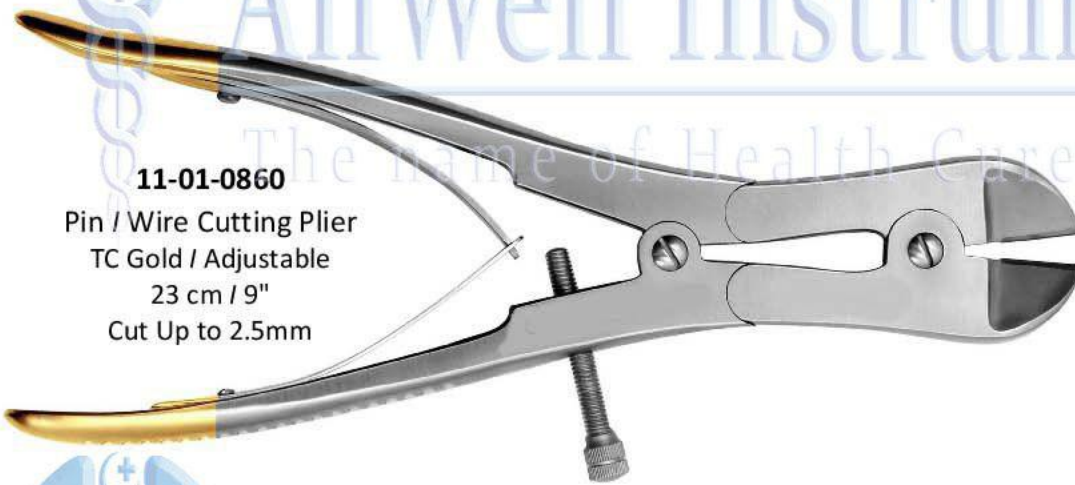

**11-01-0860**  
Pin / Wire Cutting Plier  
TC Gold / Adjustable  
23 cm / 9"  
Cut Up to 2.5mm

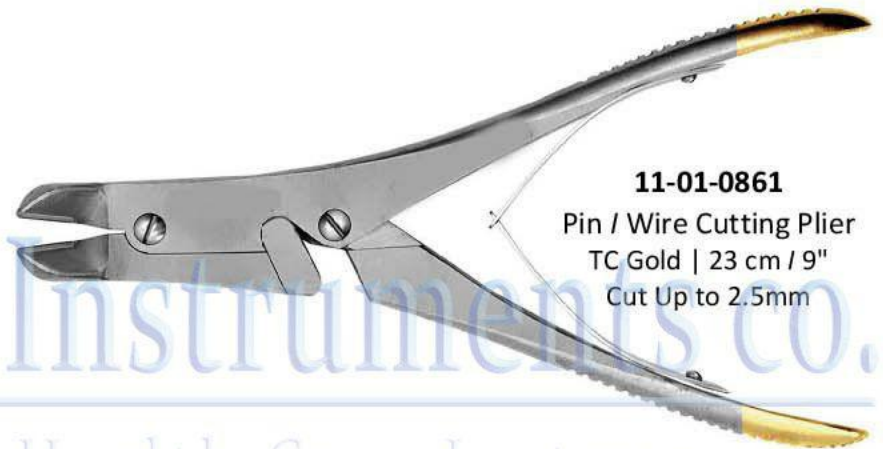

**11-01-0861**  
Pin / Wire Cutting Plier  
TC Gold | 23 cm / 9"  
Cut Up to 2.5mm

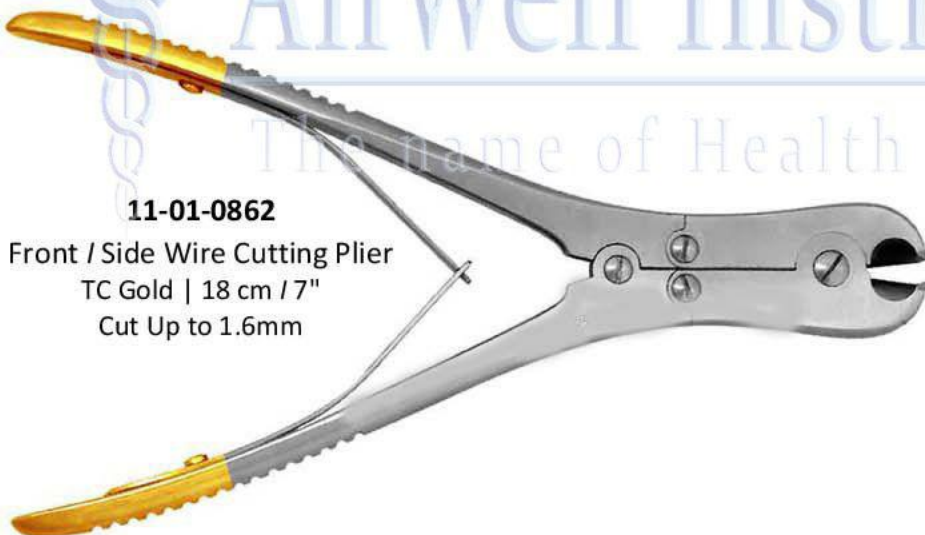

**11-01-0862**  
Front / Side Wire Cutting Plier  
TC Gold | 18 cm / 7"  
Cut Up to 1.6mm





# AllWell Instruments co.

The name of Health Cure Instruments

CARBIDE INSERTED WIRE - PIN CUTTING PLIERS



**11-01-0863**  
Heavy Duty Pin Cutting Plier  
TC Gold

- A: 30 cm / 12" Cut Up to 3mm
- B: 47 cm / 18 1/2" Cut Up to 5mm
- C: 56 cm / 22" Cut Up to 6mm
- D: 60 cm / 24" Cut Up to 7mm

# AllWell Instruments co.

The name of Health Cure Instruments



**11-01-0864**  
Heavy Duty Pin End Cutting Plier TC Gold  
A: 27 cm / 10 1/2" Cut Up to 3mm  
B: 38 cm / 15" Cut Up to 4mm

# AllWell Instruments co.

The name of Health Cure Instruments



**11-01-0865**  
Heavy Duty Rods / Steinmann Pin Cutting Plier  
TC Gold / Adjustable / Locking System  
A: 30 cm / 12" Cut Up to 3mm  
B: 38 cm / 15" Cut Up to 4mm  
C: 47 cm / 18 1/2" Cut Up to 5mm  
D: 56 cm / 22" Cut Up to 6mm



# AllWell Instruments co.

The name of Health Cure Instruments

CARBIDE INSERTED SURGICAL SCISSORS



A: 15.5 CM / 6"

B: 18 CM / 7"



B: 18 CM / 7"

A: 15.5 CM / 6"



B: 20 CM / 8"

A: 15.5 CM / 6"

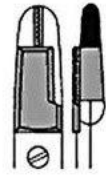

**11-01-0866**

Wire Twisting Forceps

**11-01-0867**

Wire Twisting Forceps

**11-01-0868**

Wire Twisting Forceps

**11-01-0869**

Corwin Combi-Wire Twisting Forceps 18.5 cm / 7 1/4"



**11-01-0870**

Wire Twisting Forceps  
15.5 cm / 6"



**11-01-0871**

Wire Twisting Forceps  
16 cm / 6 1/4"



**11-01-0872**

Wire Twisting Forceps  
Heavy Pattern  
19 cm / 7 1/2"

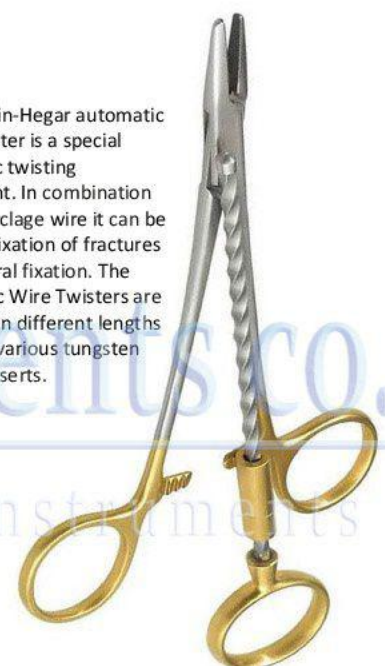

**11-01-0873**

Corwin-Hegar  
Auto Wire Twisting Forceps  
15 cm / 6"

The Corwin-Hegar automatic Wire Twister is a special automatic twisting Instrument. In combination with a cerclage wire it can be used for fixation of fractures or temporal fixation. The Automatic Wire Twisters are available in different lengths and with various tungsten carbide inserts.





# AllWell Instruments co.

The name of Health Cure Instruments

CARBIDE INSERTED SURGICAL SCISSORS

Blunt / Blunt

- A: 14.5 cm / 5 3/4" Str or Cvd
- B: 17 cm / 6 3/4" Str or Cvd
- C: 23 cm / 9" Str or Cvd



**11-01-0874**  
Mayo Scissors TC Gold

Sharp / Sharp  
Cvd or Str

Blunt / Blunt  
Cvd or Str

Sharp / Blunt  
Cvd or Str

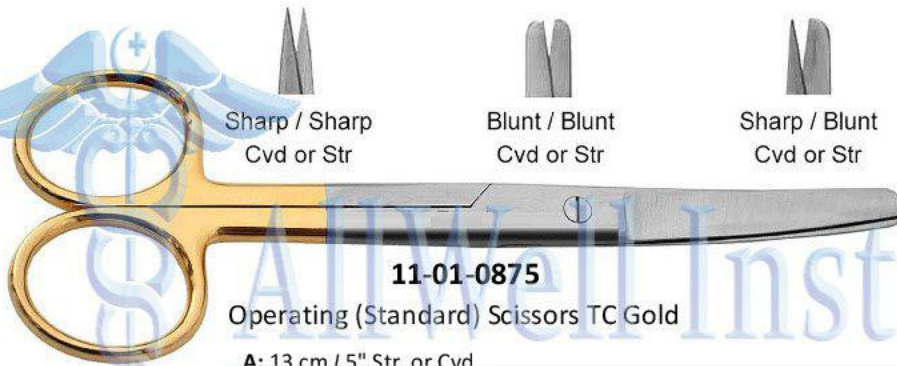

**11-01-0875**  
Operating (Standard) Scissors TC Gold

- A: 13 cm / 5" Str. or Cvd
- B: 14 cm / 5 1/2" Str. or Cvd
- C: 15.5 cm / 6 1/2" Str. or Cvd
- D: 18 cm / 7" Str. or Cvd

- A: 14.5 cm / 5 3/4" Str. or Cvd.
- B: 17 cm / 6 3/4" Str. or Cvd.
- C: 23 cm / 9" Str. or Cvd.

Blunt / Blunt



**11-01-0876**  
Mayo Stille Scissors TC Gold

- A: 14 cm / 5 1/2" Str. or Cvd
- B: 17 cm / 6 3/4" Str. or Cvd
- C: 20 cm / 8" Str. or Cvd
- D: 23 cm / 9" Str. or Cvd

Blunt / Blunt

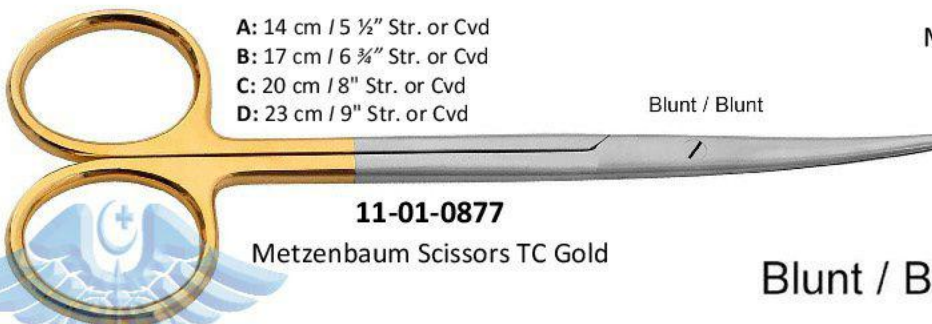

**11-01-0877**  
Metzenbaum Scissors TC Gold

Blunt / Blunt

- A: 20 cm / 8" Str. or Cvd
- B: 23 cm / 9" Str. or Cvd
- C: 28 cm / 11" Str. or Cvd
- D: 30 cm / 12" Str. or Cvd



**11-01-0878**  
Mayo-Harrington Scissors TC Gold

**11-01-0879**

Ortho Universal Scissors TC Gold  
12 cm / 4 1/3"



**11-01-0880**

Mayo-Nobel Scissors TC Gold  
16.5 cm / 6 1/2" Str. or Cvd







# AllWell Instruments co.

The name of Health Cure Instruments

INSTRUMENTS FOR TRUAMATOLOGY



## Drill Bits for Quick Coupling

Drill bit 1.1mm dia.  
for threaded hole for 1.5mm screws  
Drill bit 1.5mm dia.  
For threaded hole for 2.0mm screws and gliding hole for 1.5mm  
Screws  
Drill bit 2.0mm dia.  
For threaded hole for 2.7mm dia.  
For gliding hole for 2.7mm screws

Item	Diameter	Total length	Usable length
100.001	1.1mm	060mm	035mm
100.002	1.5mm	085mm	060mm
100.003	1.5mm	110mm	085mm
100.004	2.0mm	100mm	145mm
100.005	2.0mm	125mm	100mm
100.006	2.7mm	100mm	075mm
100.007	2.7mm	125mm	100mm
100.008	2.7mm	100mm	075mm
100.009	2.0mm	125mm	100mm

Drill bit 2.5mm dia.  
For threaded hole for 3.5 and 4.0mm screws  
Drill bit 3.5mm  
for gliding hole for 3.5mm screws

Item	Diameter	Total length	Usable length
100.010	2.5mm	110mm	085mm
100.011	2.5mm	180mm	155mm
100.012	3.5mm	100mm	085mm
100.013	3.5mm	195mm	170mm

Drill bit 3.2mm dia.  
For threaded hole for 4.5 and 6.5mm screws  
Drill bit 4mm dia.  
For gliding hole for 4.5mm screws

Item	Diameter	Total length	Usable length
100.014	2.0mm	100mm	145mm
100.015	3.2mm	225mm	200mm
100.016	3.2mm	145mm	120mm
100.017	3.2mm	195mm	170mm
100.018	4.5mm	145mm	120mm
100.019	4.5mm	195mm	170mm



## Drill Bit for Jacobs chuck

Item	Diameter	Total length	Usable length
101.001	1.1mm	45mm	30mm
101.002	1.5mm	70mm	55mm
101.003	2.0mm	85mm	70mm
101.004	2.5mm	95mm	80mm
101.005	2.7mm	85mm	70mm
101.006	3.2mm	130mm	115mm
101.007	3.2mm	180mm	165mm
101.008	3.5mm	95mm	80mm
101.009	3.5mm	180mm	165mm
101.010	4.5mm	130mm	115mm
101.011	4.5mm	180mm	165mm



### 11-01-0881

Tap for 1.5mm Cortex Screws  
Total length 50mm, thread length 20mm  
predrilling 1.1mm dia.



### 11-01-0882

Tap for 6.5mm Cancellous Bone Screws  
Length 195mm, predrilling 3.2mm dia.



### 11-01-0883

Tap for 4.0mm Cancellous Bone Screws  
Total Length 110mm, Usable Length 85mm

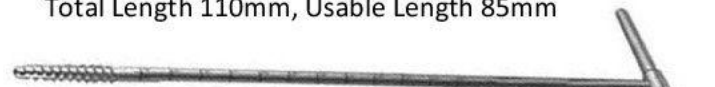

### 11-01-0884

Tap Cannulated, for 7.0mm Cannulated Screws  
Length 230mm





# AllWell Instruments co.

The name of Health Cure Instruments

INSTRUMENTS FOR TRUAMATOLOGY



Tap for 2.0mm Cortex Screws  
Predrilling: 1.5mm dia.

Tap for 2.7mm Cortex Screws  
Predrilling: 2.0mm dia.

Item	Thread	length
102.001	24mm	053mm
102.002	38mm	100mm

Item	Thread length	Total length
102.005	33mm	100mm
102.006	40mm	150mm

Tap for 3.5mm Cortex Screws  
Predrilling: 2.5mm dia.

Item	Total length	Type
102.007	175mm	with length markings
102.008	110mm	thread length 50mm

Predrilling: 3.2mm

Item	Length	Type
102.003	125mm	thread length 70mm
102.004	175mm	with length markings

### 102.009

Tap for 3.5mm Cortex Screws  
**Total Length:** 110mm  
**Thread Length:** 50mm  
**Predrilling:** 3.2mm dia.

### 102.010

Tap for 2.7mm Cortex Screws  
**Total length:** 125mm  
**Thread length:** 40mm  
**Predrilling:** 2.0mm dia.

### 102.011

Tap for 4.5mm Cortex Screws  
**Total length:** 125mm  
**Thread length:** 70mm  
**Predrilling:** 3.2mm dia.



### 11-01-0885

Countersink Shaft 1.5/2.0  
Length 52mm, for mini quick coupling



### 11-01-0886

Router, for Jacobs chuck  
Length 90mm



### 11-01-0887

Router, for quick coupling  
Length 90mm



### 11-01-0888

Countersink Shaft 3.5mm  
Length 72mm, for quick coupling,  
to countersink the screw head



### 11-01-0889

Countersink, large  
Length 180mm, for 4.5mm cortex screws



### 11-01-0890

Dountersink, cannulated, for 7.0mm cannulated Screws  
Length 230mm





# AllWell Instruments co.

The name of Health Cure Instruments  
INSTRUMENTS FOR TRUAMATOLOGY



**11-01-0891**

Screwdriver Shaft, hexagonal, small  
Length 100mm, for quick coupling  
For 2.7 to 4.0mm screws.



**11-01-0892**

Screwdriver Shaft, Hexagonal, large  
Length 100mm, final tightening of the screw has to be done by hand.



**11-01-0893**

Screwdriver Shaft, hexagonal, with Holding Sleeve  
For 1.5 and 2.0mm stainless steel screws  
With hexagonal socket,



**11-01-0894**

Screwdriver Shaft, cruciform, 1.5/ 2.0, with Holding Sleeve  
Length 50mm, for 1.5 and 2.0mm



**11-01-0895**

T-Handle with Coupling  
Length: 80mm, for taps



**11-01-0896**

Screwdriver, hexagonal, with T-Handle,  
Large to loosen tight screws.  
A normal screwdriver can be additionally inserted in the hollow shaft of the T-handle.



**11-01-0897**

Handle with mini quick coupling



**11-01-0898**

Hand Chuck for Kirschner Wires  
Length 145mm, Spannbereich 0.6 to 1.6mm dia.



**11-01-0899**

Handle with quick coupling  
Length 110mm, for countersinks and  
Instruments for the removal of damaged screws



**11-01-0900**

Handle, small, with mini quick coupling





# AllWell Instruments co.

The name of Health Cure Instruments

INSTRUMENTS FOR TRUAMATOLOGY



**11-01-0901**

Handle, medium, with mini quick coupling



**11-01-0902**

Handle, Large, with mini quick coupling



**11-01-0903**

Screwdriver, hexagonal, small with groove  
Length 200mm, for 2.7 to 4.0mm screws



**11-01-0904**

Screwdriver with Universal Joint, large  
Length 290mm



**11-01-0905**

Screwdriver, hexagonal, large, with groove  
Length 240mm



**11-01-0906**

Screwdriver, hexagonal, with Holding Sleeve,  
Length 165mm for 1.5 and 2.0mm stainless  
Steel screws with hexagonal socket



**11-01-0907**

Screwdriver, hexagonal, small, with Holding Sleeve  
Length 200mm



**11-01-0908**

Holding Sleeve for Mini Screws single

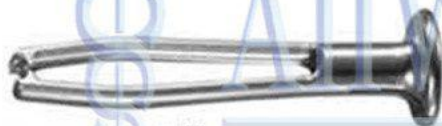

**11-01-0909**

Holding Sleeve



**11-01-0911**

Allen Key, hexagonal, angled  
For 4.5 to 7.0mm screws



**11-01-0910**

Holding Sleeve single

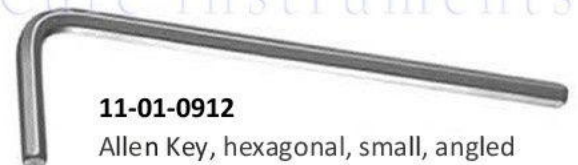

**11-01-0912**

Allen Key, hexagonal, small, angled  
Length 65mm, for 2.7 to 4.0mm screws





# AllWell Instruments co.

The name of Health Cure Instruments

INSTRUMENTS FOR TRUAMATOLOGY



**11-01-0913**

Insert Drill Sleeve 3.5/2.5  
Length 42mm, drill bit 2.5mm dia.



**11-01-0914**

Insert Drill Sleeve 4.5/3.2  
Length 80mm for long lag screws



**11-01-0915**

Trocar 2.0mm dia., Length 118mm, for percutaneous insertion of 7.0mm cannulated screws



**11-01-0917**

Drill Sleeve 8.0/4.5  
Length 100mm, for percutaneous insertion of 7.0mm cannulated screws



**11-01-0916**

Drill Sleeve 4.5/ 2.0  
Length 109mm, for percutaneous insertion of 7.0mm cannulated screws



**11-01-0918**

Handle for Drill Guides single



**11-01-0920**

Handle for Drill Guides single

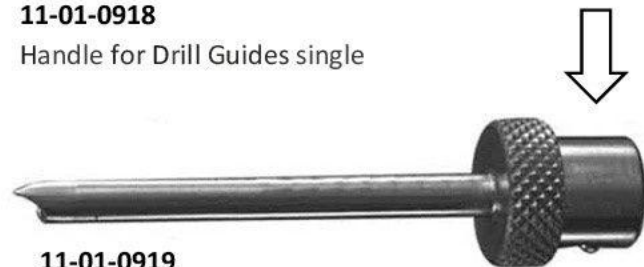

**11-01-0919**

Drill Sleeve 3.0 with point length 55mm

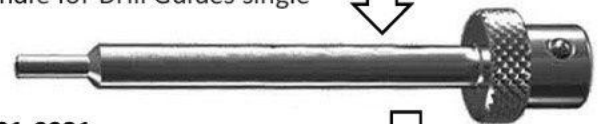

**11-01-0921**

Drill Sleeve 1.5mm / 2.0 / 2.7mm

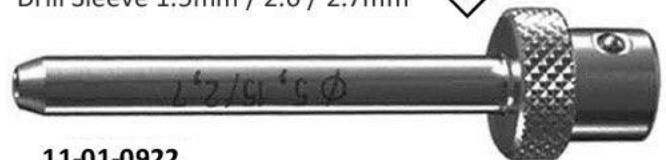

**11-01-0922**

Drill Sleeve 2.7



**11-01-0923**

Double Drill Sleeve 1.5/101  
For 1.5mm cortex screws  
Drill bits, 1.5 and 1.1mm dia.



**11-01-0924**

Double Drill Sleeve 2.0/1.5 for  
2.7mm cortex screw



**11-01-0925**

Double Drill Sleeve 2.7/2.0  
For 2.7mm cortex screws



**11-01-0926**

Double Drill Sleeve 3.5/2.5  
For 3.5mm cortex screws and 4.0mm  
cancellous bone screws  
Drill bits 3.5 and 2.5 dia.,





# AllWell Instruments co.

The name of Health Cure Instruments

INSTRUMENTS FOR TRUAMATOLOGY



**11-01-0927**

Double Drill Sleeve 4.5/3.2  
For 4.5mm cortex screws  
Drill bits: 4.5 and 3.2mm dia.

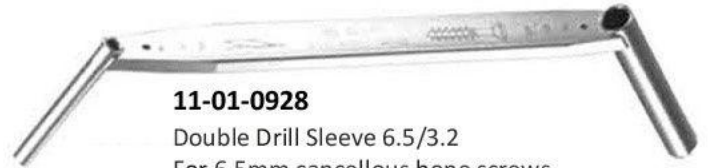

**11-01-0928**

Double Drill Sleeve 6.5/3.2  
For 6.5mm cancellous bone screws  
Drill bit: 3.2mm dia.



**11-01-0929**

Universal Drill Sleeve 2.7  
Drill bits 2.0 and 2.7mm dia.,  
Suitable for LC-DCP and round hole plates.



**11-01-0930**

Universal Drill Guide 3.5  
Drill bit 2.5 and 3.5mm dia., and tissue protection  
Suitable for LC-DCP and round hole plates.



**11-01-0931**

Universal Drill Guide 4.5/3.2  
Drill bits 3.2 and 4.5mm dia.



**11-01-0932**

DCP Drill Guide 2.0  
For neutral and load position  
Drill bit 1.5mm dia.



**11-01-0933**

DCP Drill Guide 2.7  
For neutral and load position  
Drill bit 2.0mm dia.



**11-01-0934**

DCP Drill Guide 3.5  
For neutral a load position, drill bit 2.5mm dia.



**11-01-0935**

DCP Drill Guide 4.5  
For neutral and load position, drill bit  
3.2mm dia.



**11-01-0936**

LC-DCP Drill Guide 3.5  
For neutral a load position, drill bit 2.5mm dia.

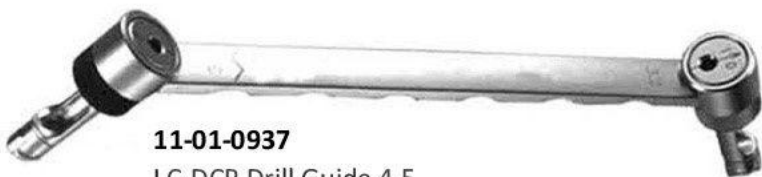

**11-01-0937**

LC-DCP Drill Guide 4.5  
For neutral and load position, drill bit 3.2mm dia.



**11-01-0938**

DCP Hip Drill Guide 4.5, for neutral  
and load position, for 4.5mm screws  
with DHS and angled blade plates, sleeve  
length 60mm, drill bit 3.2mm dia.





# AllWell Instruments co.

The name of Health Cure Instruments

INSTRUMENTS FOR TRUAMATOLOGY



**11-01-0939**

Triple Drill Sleeve 2.0  
with 3 holes, opposite side 1 hole

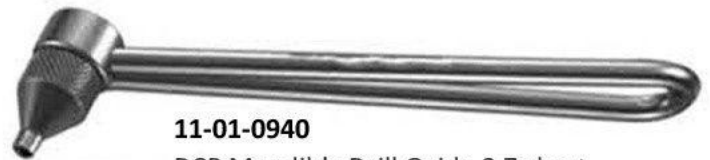

**11-01-0940**

DCP Mandible Drill Guide 2.7 short  
drill bit 2.0mm dia.



**11-01-0941**

DCP Mandible Drill Guide 2.7 long  
drill bit 2.0mm dia.



**11-01-0942**

Insert Drill Sleeve with stop, for 4.5mm screws  
adjustable length to limit drilling depth,  
external dia. 4.5mm for drill bits of 3.2mm dia.



**11-01-0943**

Parallel drill Guide 4.5  
For percutaneous insertion of 7.0mm cannulated screws



**11-01-0944**

Parallel Wire Guide 2.0mm dia.



**11-01-0945**

Depth Gauge for 2.7 to 4.0m screws  
measuring range up to 60mm



**11-01-0948**

Bending Iron for plates 2.7 and 3.5  
Length 150mm, slid widths 2.5 and 4.5mm, required paris  
Slid placement: 4.5 / 2.5  
Slid placement: 2.5/4.5



**11-01-0946**

Depth Gauge for 2.7 to 4.0mm screws measuring  
range up to 60mm



**11-01-0947**

Depth Gauge for 4.5mm to 6.5mm screws measuring  
range up to 110mm



**11-01-0949-1**

Bending Iron for plates 1.5 and 2.5  
Length: 130mm, slid width: 2.5mm





# AllWell Instruments co.

The name of Health Cure Instruments

INSTRUMENTS FOR TRUAMATOLOGY

**11-01-0949-2**

Triple Drill Guide

130° angle, for 130° angled blade plates and for condylar plates, drill bit 4.5mm dia.



**11-01-0950**

Drill Guide with stop 3.5/2.7 to limit drilling depth



**11-01-0951**

Protection Sleeve 11.0/8.0 for percutaneous insertion of 7.0mm cannulated screws



**11-01-0952**

Holding Sleeve Length 80mm, for 2.7 to 4.0mm screws



**11-01-0953**

Holding Sleeve for length 80mm for 2.7mm screws and 3.5mm cannulated screws

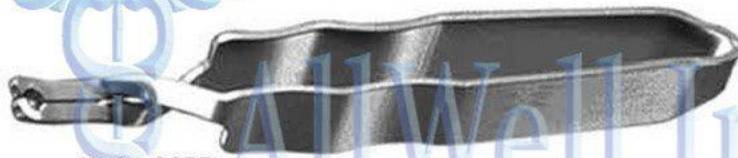

**11-01-0955**

Screw Forceps, self-holding Length 85mm, to take screws out of the screw racks



**11-01-0954**

Holding Sleeve, large, length 120mm



**11-01-0956**

Drill Sleeve, pointed



**11-01-0957**

Bending Iron LC-DCP/DCP Length 250mm, for small and broad LC-DCP, DCP Slit widths 5 and 7mm, required in pairs





# AllWell Instruments co.

The name of Health Cure Instruments

INSTRUMENTS FOR TRUAMATOLOGY



**11-01-0958**

Bending Iron for Kirschner Wires  
Length 120mm, for 1.25 to 2.5mm dia.



**11-01-0959**

Bending Iron for Kirschner Wires  
Length 115mm, for 0.8 to 1.25mm dia.



**11-01-0960**

Bending Iron for Reconstruction Plates 3.5 and 4.5  
Length 190mm, required in paris

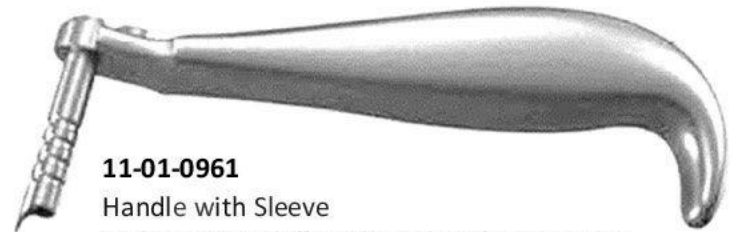

**11-01-0961**

Handle with Sleeve  
with rotating drill guide and anchoring point



**11-01-0962**

Trocar Point, large



**11-01-0964**

Combination Wrench 11mm length 140mm

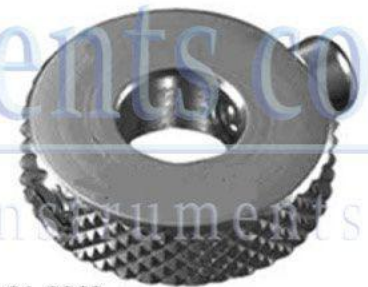

**11-01-0963**

Cheek Retractor Ring



**11-01-0965**

Pin Wrench, length 120mm, 4.5mm dia.  
For tension device, distractor and knurled  
nut of insertion handle for intramedullary nail



**11-01-0966**

Socket Wrench 11mm  
Length 200mm



**11-01-0967**

Slotted Hammer  
Length 270mm



**11-01-0968**

Inserter/Extractor, with Adjustable Clamps, length 270mm, for the  
insertion and extraction of angled plates for adults and hip plates for  
adolescents and children as well as tibial plateau osteotomy plates.



**11-01-0969**

Measuring Device  
For drill bits, screws, Kirschner wires,  
and Steinmann pins





# AllWell Instruments co.

The name of Health Cure Instruments

INSTRUMENTS FOR TRUAMATOLOGY



**11-01-0970**

Inserter/Extractor

Length 175mm, for infant hip plate and mini hip plate.



**11-01-0971**

Bending Pliers for Reconstruction Plates 2.7 and 3.5  
Length 240mm

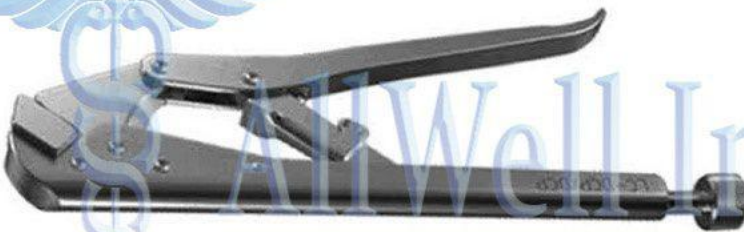

**11-01-0972**

Bending Pliers for plate 2.4 to 4.0  
Length 230mm



**11-01-0973**

Cutter for thin plates 1.5 to 2.7  
Length 256mm



**11-01-0974**

Bending Pliers

For reconstruction plates 2.7,  
Length 270mm, required in paris



**11-01-0975**

Cerclage Wire Tightener

Length 260mm

For twisting, for temporary fixation during reduction



**11-01-0976**

Bending Pliers for Plates

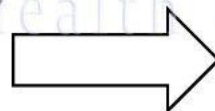

**11-01-0977**

Anvil, narrow



**11-01-0978**

Anvil, Large



# AllWell Instruments co.

The name of Health Cure Instruments

INSTRUMENTS FOR TRUAMATOLOGY

**11-01-0979**

Bending Press  
Length 400mm



**11-01-0980**

Tension Device, articulated  
Span 20mm, can also be used as a distractor.  
Color scale: yellow up to 500N, green up to 1000N,  
red above 100N.



**11-01-0981**

Chisel Guide  
With adjustable angle



**11-01-0983**

Blade with foot single

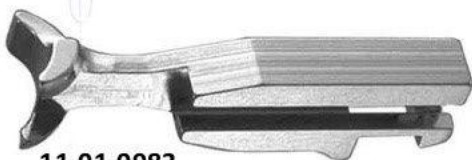

**11-01-0984**

Blade with tip single

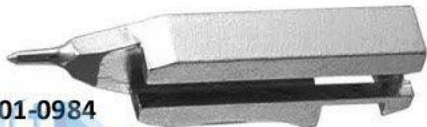

**11-01-0982**

Forceps with Sliding Blades  
Complete with two interchangeable blades  
Length 155mm, weight 42 g, speed lock



**11-01-0985**

Wire Passer 45mm bending diameter



**11-01-0986**

Wire Passer 70mm bending diameter



**11-01-0987**

Holding Clip



**11-01-0988**

Wire Tightener  
Length 240mm, with handle and two pegs







# AllWell Instruments co.

The name of Health Cure Instruments

INSTRUMENTS FOR TRUAMATOLOGY



**11-01-0989**

Handle with quick coupling  
Length 150 mm



**11-01-0990**

Cancellous Bone Impactor, curved, 6mm dia.  
Length 140 mm



**11-01-0991**

Cancellous Bone Impactor, curved, 6mm dia.  
Flattened, Length 140 mm



**11-01-0992**

Cancellous Bone Impactor, straight, 8 mm dia.  
Length 140 mm



**11-01-0993**

Cancellous Bone Impactor, rectangular,  
6x16mm, Length 140 mm



**11-01-0994**

Cancellous Bone Impactor, rectangular,  
10x20mm, Length 140mm

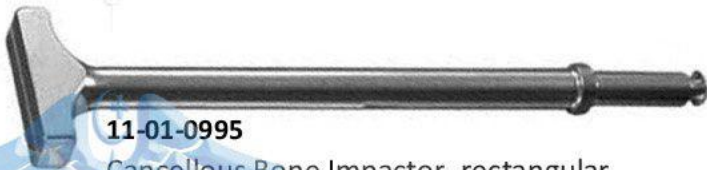

**11-01-0995**

Cancellous Bone Impactor, rectangular,  
10x30mm, Length 140 mm



**11-01-0996**

Rasp round  
Length: 140 mm

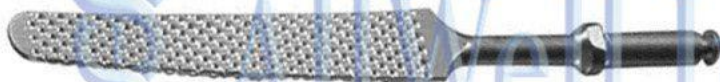

**11-01-0997**

Rasp, half-round  
Length: 140 mm



**11-01-0998**

Gouge, straight, 5mm wide  
Length 140 mm



**11-01-0999**

Gouge, curved, 5mm wide  
Length 140 mm



**11-01-1000**

Gouge, straight, 10 mm wide  
Length 140mm



**11-01-1001**

Gouge, curved, 10 mm wide  
Length 140 mm



**11-01-1002**

Gouge, curved, 15 mm wide  
Length 140 mm



# AllWell Instruments co.

The name of Health Cure Instruments

INSTRUMENTS FOR TRUAMATOLOGY



**11-01-1003**

Gouge, straight, 15 mm wide  
Length 140 mm



**11-01-1004**

Chisel, flat, curved, 16 mm wide  
Length 140 mm



**11-01-1005**

Chisel, flat, straight, 16 mm wide  
Length 140 mm



**11-01-1006**

Chisel, flat, curved, 4 mm wide  
Length 140 mm



**11-01-1007**

Chisel, flat, 20 mm wide  
Length 140 mm



**11-01-1008**

Chisel, flat, curved, 8 mm wide  
Length 140 mm



# AllWell Instruments co.

The name of Health Cure Instruments





# **AllWell Instruments co.**

**The name of Health Cure Instruments**

ADD: SARDAR PURA DEFENCE ROAD  
MUZAFAR PUR S.I.E 51340 SIALKOT.  
TEL: 0092 52 3242356 FAX: 0092 52 3242356  
CELL: 0092 3216121965  
INFO@ALLWELLINST.COM  
IMRANASGHAR65@GMAIL.COM  
WWW.ALLWELLINST.COM