



AllWell Instruments co.

The name of Health Cure Instruments





Dear Valued Buyers

We feel immense pleasure to present our latest catalogue in which we have featured a most comprehensive range of all types of quality Surgical & Dental instruments required for day to day use for Hospital. We will be pleased to quote you a competitive Price and Delivery time.

All instruments are manufactured according to the recognized standard patterns currently in use in Hospital throughout the world and are being produced under restrict control of experts to avoid any flaw and to refrain any complaint at any stage.

A group of very vast experienced persons in manufacturing handling our quality Control System.

Any instruments proven defective in workmanship or material will be replaced with out charges.

We express our thanks to all our customers for the confidence they have placed us in the past. We further assure them that we will continue our best efforts to gain their confidence in the future.

We are always at your service.

Chief Executive

AllWell Instruments co.
The name of Health Care Instruments





01

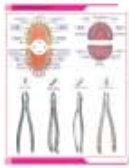

EXTRACTING FORCEPS

Page # 01 - 14H

02



ROOT ELEVATORS

Page # 15 - 29

03



**DIAGNOSTIC, PROBES, SCALERS, FILLING
& LABORATORY INSTRUMENTS**

Page # 30 - 77

04



**MAXILLOFACIAL SURGERY
INSTRUMENTS**

Page # 78 - 95

05



**ORTHODONTIC INSTRUMENTS
& PLIERS**

Page # 96 - 107

06



DENTAL IMPLANT INSTRUMENTS

Page # 108 - 142

07

impression Tray & Hollow wares

Page # 143 - 148



CENTIMETERS

EXTRACTING FORCEPS

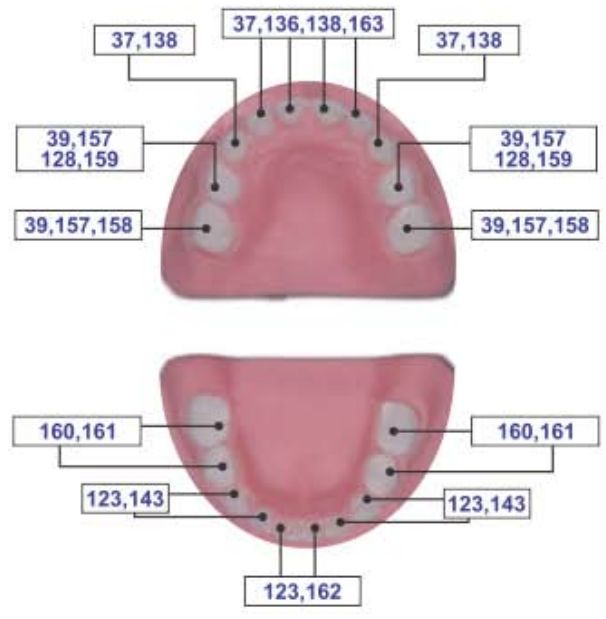
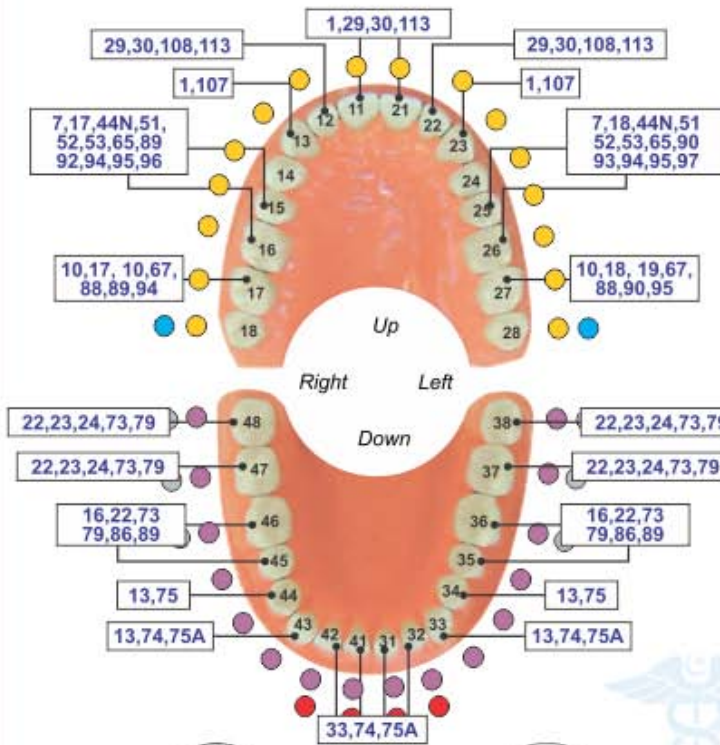

English Pattern



English Pattern, Anatomic Handle



American Pattern



Deep Grip Forceps





EXTRACTING FORCEPS (English Pattern)

- Щипцы экстракционные (английская форма)
- Daviers (Forme Anglaise)
- Zahnzangen (Englische Form)

- Щипці екстракційні (англійська форма)
- Forceps de Extracción (Forme Inglesa)
- استخراج الملقط (نمط اللغة الإنجليزية)

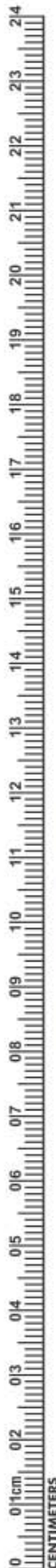

DE-001
Fig. 1
Upper Centrals
and Canines



DE-002
Fig. 2
Upper Laterals
and Canines



DE-003
Fig. 4
Lower Incisors
and Canines



DE-004
Fig. 7
Upper Premolars



DE-005
Fig. 8
Lower Premolars



DE-006
Fig. 13
Lower Premolars



DE-007
Fig. 17
Upper Molars,
Right



DE-008
Fig. 18
Upper Molars,
Left



DE-009
Fig. 21
Lower Molar



DE-010
Fig. 22
Lower Molar

EXTRACTING FORCEPS (English Pattern)



- Щипцы экстракционные (английская форма)
- Давиеры (Forme Anglaise)
- Zahnzangen (Englische Form)
- Щипці екстракційні (англійська форма)
- Forceps de Extracción (Forme Inglesa)
- استخراج الملقط (نمط اللغة الإنجليزية)



DE-011
18A
upper molars



DE-012
19
upper third molars



DE-013
20
lower third molar



DE-014
24
lower molar, right



DE-015
29
upper roots

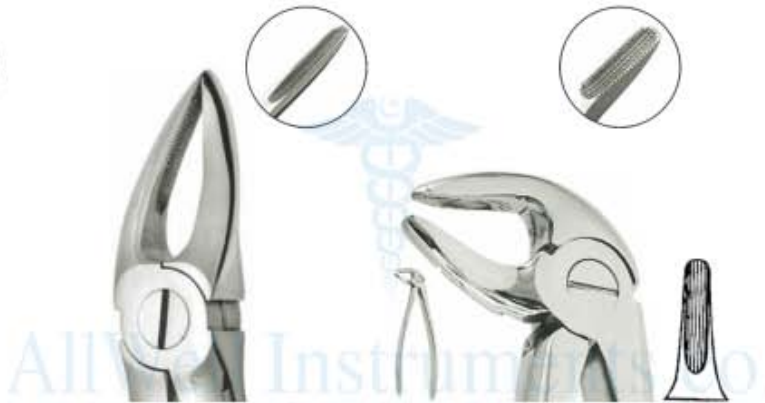

DE-016
30
Upper Roots



DE-017
33
lower roots



DE-018
33A
Lower Roots



DE-019
33M
Lower roots
with long beak



DE-020
46L



DE-021
51
Upper Roots



DE-022
51A
Upper Roots





- Щипцы экстракционные (английская форма)
- Daviers (Forme Anglaise)
- Zahnzangen (Englische Form)
- Щипці екстракційні (англійська форма)
- Forceps de Extracción (Forme Inglesa)
- استخراج الملقط (نمط اللغة الإنجليزية)

WISDOM EXTRACTING FORCEPS



DE-023
Routurier
(# 22 ½ L)
lower molars and
wisdoms, left



DE-024
Routurier
(# 22 ½ R)
lower molars and
wisdoms, right



DE-025
Routurier
(# 33 ½ L)
lower molar and
wisdom roots, left



DE-026
Routurier
(# 33 ½ R)
lower molar and
wisdom roots, right



DE-027
Fig. 186L
lower molars



DE-028
Fig. 186R
lower molars



DE-029
51AL



DE-030
67
Upper Thrid Molars



DE-031
67A
Upper Thrid Molars



DE-032
79
Lower Third Molars



EXTRACTING FORCEPS (English Pattern)



- Щипцы экстракционные (английская форма)
- Daviers (Forme Anglaise)
- Zahnzangen (Englische Form)
- Щипці екстракційні (англійська форма)
- Forceps de Extracción (Forme Inglesa)
- استخراج الملقط (نمط اللغة الإنجليزية)



DE-033
73
Lower Molars



DE-034
73 A
lower molars



DE-035
73 S



DE-036
74
Lower Roots



DE-037
74N
Lower Roots



DE-038
75
Lower Premolars



DE-039
86A
Lower Molars



DE-040
86B
lower molars



DE-041
86C
lower molars



DE-042
87
Lower Molars



DE-043
89
Upper Molars,
Right



DE-044
90
Upper Molars,
Left





EXTRACTING FORCEPS (English Pattern)

- Щипцы экстракционные (английская форма)
- Daviers (Forme Anglaise)
- Zahnzangen (Englische Form)

- Щипці екстракційні (англійська форма)
- Forceps de Extracción (Forme Inglesa)
- استخراج الملقط (نمط اللغة الإنجليزية)

A-TRAUMATIC EXTRACTION
Improved tapered beaks for complete root contact. Cross serrations.
Deep Gripe Extracting Forceps



- No Fracture
- No Tissue Damage
- Extraction With Easy



Thin Tip



DE-045
34
Upper incisors and
premolars
deep-gripping



Wide Tip



DE-046
34A
Upper centrals / cains
deep-gripping



Thin Tip



DE-047
Fig. 35
upper permolars
deep-gripping



Wide Tip



DE-048
35A
Upper incisors and
premolars
deep-gripping



Thin Tip



DE-049
36
Lower premolars
deep-gripping



Wide Tip



DE-050
36A
Lower premolars
deep-gripping



DE-051
336
lower permolars
deep-gripping



DE-052
F-7C
lower molar



DE-053
9
Apex Forceps Lower Universal
Deep Root Pick



DE-054
79N
Lower third molars
deep-gripping



DE-055
79
Lower Thrid Molars





- Щипцы экстракционные (английская форма)
- Daviers (Forme Anglaise)
- Zahnzangen (Englische Form)
- Щипці екстракційні (англійська форма)
- Forceps de Extracción (Forme Inglesa)
- استخراج المنقط (نمط اللغة الإنجليزية)

DEEP GRIP FORCEPS



DE-056
146

Apex Forceps Lower Root
Deep Root Pick



DE-057
153

Apex Forceps Upper Root
Deep Root Pick



DE-058
149

Apex Forceps Upper Root
Deep Root Pick



DE-061
Fig. 44



DE-060
Fig. 44Z



DE-059
Fig. 45Z



DE-062
46XL
Apex Forceps Lower Root
Deep Root Pick



DE-063
67
Upper Third Molars



DE-064
67A
Upper Third Molars



DE-065
67N
Lower third molars
deep-gripping



DE-066
331
upper roots
deep-gripping





EXTRACTING FORCEPS (English Pattern)

- Щипцы экстракционные (английская форма)
- Щипці екстракційні (англійська форма)
- Daviers (Forme Anglaise)
- Forceps de Extracción (Forme Inglesa)
- Zahnzangen (Englische Form)
- استخراج الملقط (نمط اللغة الإنجليزية)

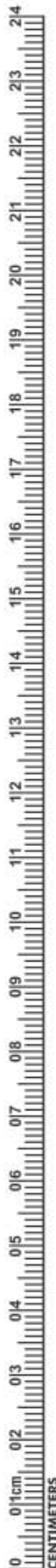

Fig. 1
upper
laterals
and canines



- DE-067** Set of 10 Pieces
Fig. 1
Fig. 7
Fig. 13
Fig. 17
Fig. 18
Fig. 22
Fig. 51A
Fig. 67
Fig. 74N
Fig. 79

Fig. 7
upper
premolars



Fig. 13
lower
premolars



Fig. 17
upper
molars,
right



Fig. 18
upper
molars,
left



Fig. 22
lower
roots



Fig. 51A
upper roots



Fig. 67
upper third
molars



Fig. 74N
lower
molar



Fig. 79
lower third
molars



EXTRACTING FORCEPS



- Щипцы экстракционные
- Daviers
- Zahnzangen
- Щипці екстракційні
- Forceps de Extracción
- استخراج الملقط

Pediatric Tooth Extracting Forceps Set



DE-069
English Pattern Klein #51S
Pedodontic Upper root



DE-068
English Pattern Klein #137
Pedodontic, Upper Incisors Spring handle



DE-072
English Pattern Klein #5
Pedodontic Lower Incisors.



DE-070
English Pattern Klein #139
Pedodontic Upper Premolars

Baby Tooth Extraction Forceps



Fig. # 01 to 07
Set of 7 Pieces



DE-073
English Pattern Klein #7
Pedodontic Lower Roots,



DE-071
English Pattern Klein #3
Pedodontic Upper Molars Universal

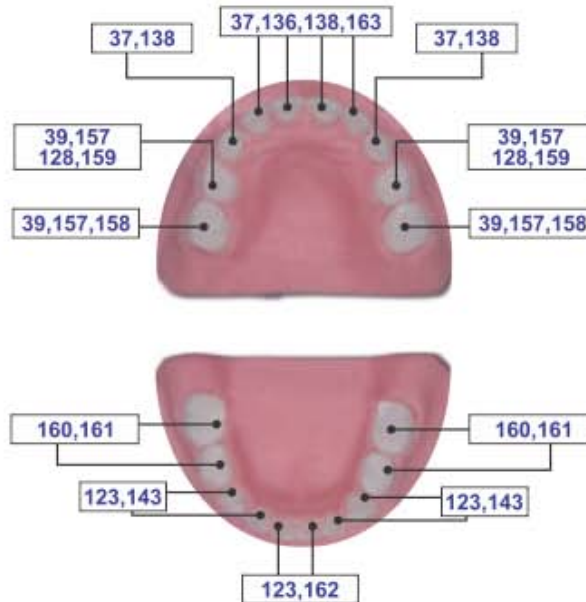

DE-074
English Pattern Klein #6
Pedodontic Lower Molars, Spring Handle





EXTRACTING FORCEPS (American Pattern)

- Щипцы экстракционные (американская форма)
- Daviers - forme americane
- Fôrceps de extracción - forma americana
- Щипці екстракційні (американська форма)
- Pinzoper per estrazione - forma americana
- استخراج المنقط (النمط الأمريكي)



DE-075
1STD
Winter
upper centrals and canines



DE-076
Fig. 1
upper incisors
and roots



DE-077
Cryer
Fig. 150



EXTRACTING FORCEPS (American Pattern)



- Щипцы экстракционные (американская форма)
- Давиеры - forme americane
- Férceps de extracción - forma americana
- Щипці екстракційні (американська форма)
- Pinzere per estrazione - forma americana
- استخراج المنقط (النمط الأمريكي)



DE-079
Fig. 62
incisors, premolars,
deciduous teeth



DE-080
10S
upper roots



DE-081
17
lower molars

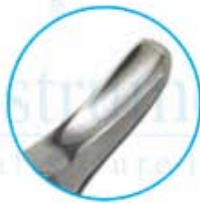
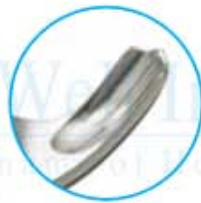

DE-082
Harris
Fig. 18R



DE-083
Harris
Fig. 18L



DE-078
Fig. 150A
Cryer
upper incisors, premolars, roots





EXTRACTING FORCEPS (American Pattern)

- Щипцы экстракционные (американская форма)
- Daviers - forme americane
- Fôrceps de extracción - forma americana
- Щипці екстракційні (американська форма)
- Pinzoper per estrazione - forma americana
- استخراج المنقط (النمط الأمريكي)



DE-084
Fig. 210
upper third molars



DE-085
Fig. 53R
upper molars, right



DE-086
Fig. 53L
upper molars, left



DE-087
NEVIUS
Fig. 88R



EXTRACTING FORCEPS (American Pattern)

AllWell Instruments co.
The name of Health Care Instruments



- Щипцы экстракционные (американская форма)
- Давиеры - forme américaine
- Férceps de extracción - forma americana
- Щипці екстракційні (американська форма)
- Pinzere per estrazione - forma americana
- استخراج المنقط (النمط الأمريكي)



DE-088
Fig. 24
upper molars



DE-089
210S
upper third molars



DE-090
210H
upper third molars



DE-091
286
Upper Roots,
Premolars, Incisors



DE-092
99C
Kells
upper incisors,
canines, premolars



DE-093
222
lower third molars



DE-094
286
Lower Molar





EXTRACTING FORCEPS (American Pattern)

- Щипцы экстракционные (американская форма)
- Daviers - forme américaine
- Fôrceps de extracción - forma americana
- Щипці екстракційні (американська форма)
- Pinzaper per estrazione - forma americana
- استخراج المنقط (النمط الأمريكي)



DE-095
Nevis
Fig. 88L
upper molars, left



DE-096
Fig. 65
upper incisors
and roots



DE-097
Parmly Fig. 32A
upper premolars
and roots



DE-098
Parmly Fig. 32
upper premolars
and molars



EXTRACTING FORCEPS (American Pattern)

AllWell Instruments co.

The name of Health Care Instruments



- Щипцы экстракционные (американская форма)
- Dавiers - forme américaine
- Fórceps de extracción - forma americana
- Щипці екстракційні (американська форма)
- Pinzere per estrazione - forma americana
- استخراج المنقط (النمط الأمريكي)

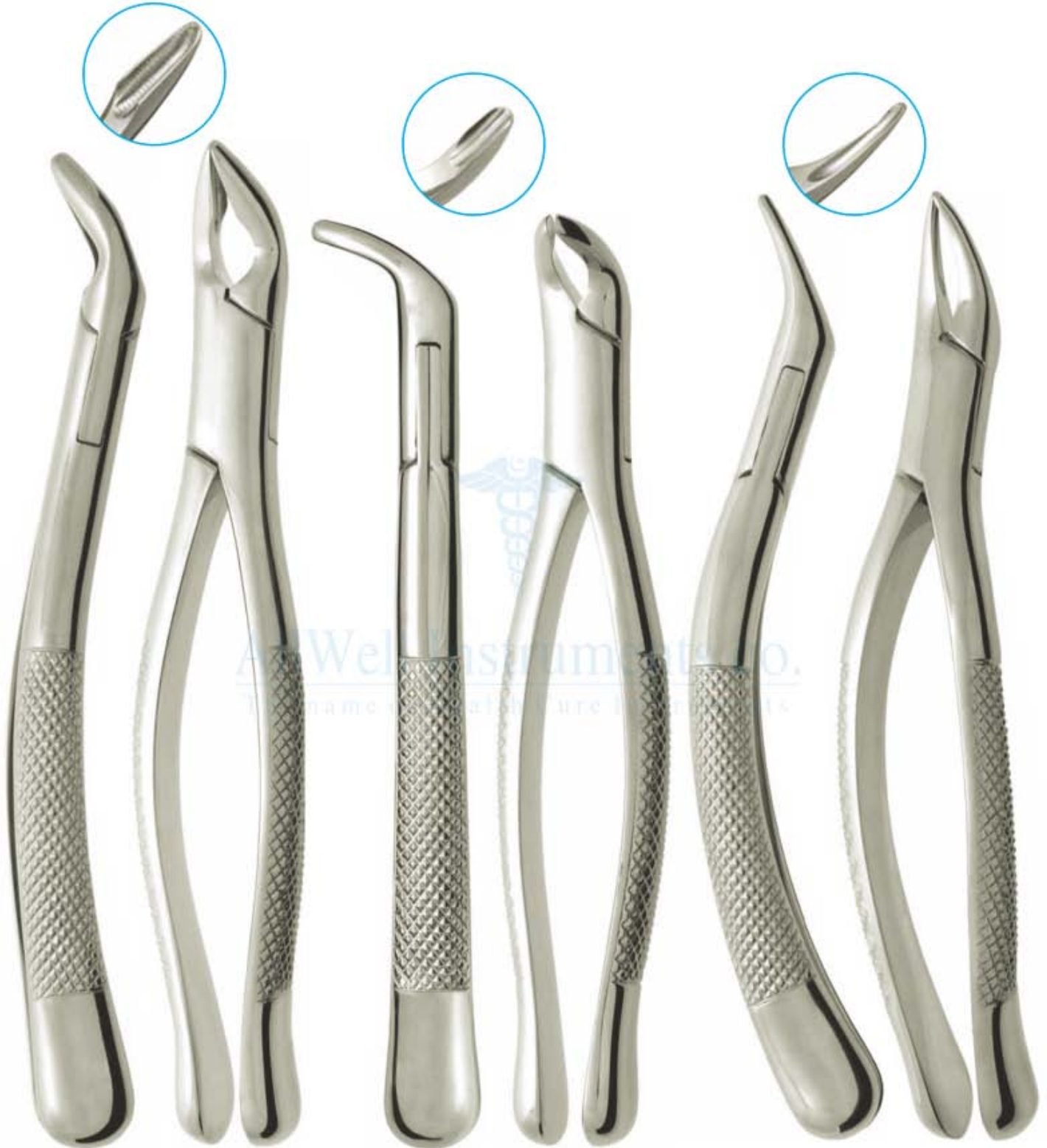

DE-099
COHEN
universal

DE-100
Fig. 203
lower incisors
and roots

DE-101
Tomes Fig. 69
upper and lower
roots



EXTRACTING FORCEPS (American Pattern)

- Щипцы экстракционные (американская форма)
- Daviers - forme américaine
- Fôrceps de extracción - forma americana
- Щипці екстракційні (американська форма)
- Pinzener per estrazione - forma americana
- استخراج المنقط (النمط الأمريكي)



DE-102
Fig. 23
lower molars



DE-103
Fig. 16
lower molars



DE-104
Physic Fig. 5
lower third molars



DE-105
Harris Fig. 15
lower molars



DE-106
Fig. 103



EXTRACTING FORCEPS (American Pattern)

AllWell Instruments co.
The name of Health Care Instruments



- Щипцы экстракционные (американская форма)
- Daviers - forme américaine
- Férceps de extracción - forma americana
- Щипці екстракційні (американська форма)
- Pinzere per estrazione - forma americana
- استخراج الملقط (النمط الأمريكي)



DE-107
Hull
Fig. 101
Deciduous teeth

DE-108
Cryer
Fig. 150S
upper teeth,
for children

DE-109
Fig. 150 AS



EXTRACTING FORCEPS (American Pattern)

- Щипцы экстракционные (американская форма)
- Daviers - forme américaine
- Fôrceps de extracción - forma americana
- Щипці екстракційні (американська форма)
- Pinzaper per estrazione - forma americana
- استخراج المنقط (النمط الأمريكي)

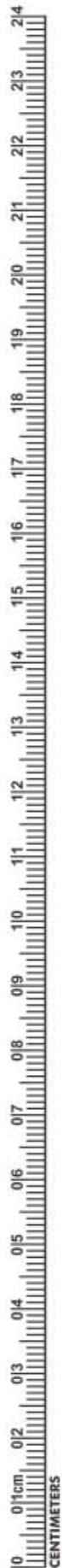

DE-110
Cryer
Fig. 151
lower teeth,
for children

DE-111
Fig. 151 S
lower incisors,
premolars, roots

DE-112
Fig. 151 AS

EXTRACTING FORCEPS (American Pattern)

AllWell Instruments co.
The name of Health Care Instruments



- Щипцы экстракционные (американская форма)
- Давиеры - forme americane
- Férceps de extracción - forma americana
- Щипці екстракційні (американська форма)
- Pinzere per estrazione - forma americana
- استخراج المنقط (النمط الأمريكي)



DE-113
16S
lower molars for children



DE-114
17S
lower molars



DE-115
23 S
Lower molars

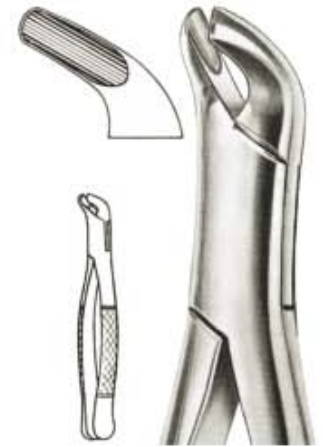

DE-116
27
lower molars



DE-117
18LS
upper molars left



DE-118
18RS
upper molars right



DE-119
85 Tomas
lower canines, premolars and molars



DE-120
85A Tomas
lower canines, premolars and molars



DE-121
69S
upper and lower roots



DE-122
99A Kells
upper incisors, canines, premolars



DE-123
217
lower molars





EXTRACTING FORCEPS (American Pattern)

- Щипцы экстракционные (американская форма)
- Daviers - forme américaine
- Fórceps de extracción - forma americana
- Щипці екстракційні (американська форма)
- Pinzaper per estrazione - forma americana
- استخراج المنقط (النمط الأمريكي)



DE-124
#10 SK
Upper Molars Sup



DE-125
#17 SK Universal
Lower Molars



DE-126
#23 SK Universal
Upper Molars



DE-127
#69 SK Tomas
upper and lower roots



DE-128
#99 SK
upper incisors,
canines, premolars



DE-129
#150 SK
upper incisors,
premolars, roots



DE-130
#151 SK
lower incisors,
premolars, roots



DE-131
#222 SK
lower third molars



EXTRACTING FORCEPS (American Pattern)

AllWell Instruments co.
The name of Health Care Instruments



- Щипцы экстракционные (американская форма)
- Dáviers - forme américaine
- Fórceps de extracción - forma americana
- Щипці екстракційні (американська форма)
- Pinzere per estrazione - forma americana
- استخراج المنقط (النمط الأمريكي)



DE-132
Fig. 1
Upper Anterior

DE-133
Lower Molar
Fig. 23 Cow Horn



DE-134
Fig. 74
Lower Anterior



DE-135
Fig. 88L
Upper Molar Left



DE-136
Fig. 88R
Upper Molar Right



DE-137
Fig. 74
Lower Anterior



DE-138
Fig. 106
Lower Incisors



DE-139
Fig. 174
Extra Narrow
Lower Anterior
Apical Retention
Forceps



DE-140
Fig. 859
Lower Molars
Roots





- Шприцы стоматологические карпульные
- Seringues à usage dentaire
- Dentsal spritzen
- Шприці стоматологічні карпульні
- Jeringas dentales
- المحاقن الأسنان



DE-141 1.8ML
DE-142 2.2ML



DE-143 1.8ML
DE-144 2.2ML



DE-145 1.8ML
DE-146 2.2ML



DE-147 1.8ML
DE-148 2.2ML



DE-149 1.8ML
DE-149A 2.2ML



DE-149B 1.8ML
DE-149C 2.2ML



DE-149D
1001
Intraligamental
Anesthesia Syringe
in Black Colour



DE-149E 1.8ML
DE-149F 2.2ML
Angled



DE-149G
Aluminium - Dark 1.8 ml



DE-149H
Aluminium - Silver 1.8 ml



DE-149I
Aluminium - Orange 1.8 ml



DE-149J
Aluminium - Green 1.8 ml



DE-149K
Aluminium - Blue 1.8 ml

BONE ROUNGER



- Костные кусачки
- Hohlmeißelzangen
- Pincers-gouges
- Кусачки для кісток
- Pinzas-gubias
- روتجیورس العظام



DE-149L
Blumenthal
15cm



DE-149M
Blumenthal
15cm



DE-149N
Blumenthal
15cm



DE-149O
Friedman
14cm



DE-149P
Friedman
14.5cm



DE-149Q
Micro-Friedman
14cm



DE-149R
Micro-Friedman
15cm



DE-149S
Micro-Friedman
16cm



DE-149T
Kleinert-Kutz
18.5cm



DE-149U
Beyer
18.5cm



DE-149V
Mead 1A
18.5cm



DE-149W
Luer
18.5cm



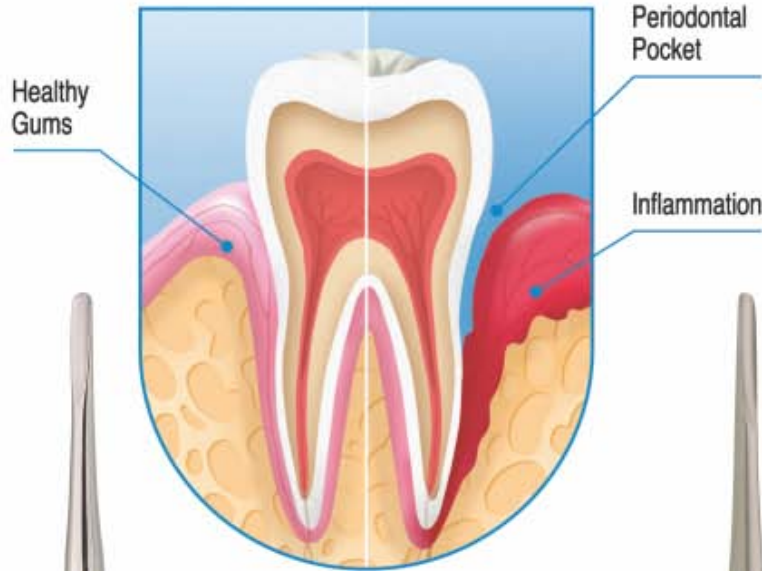

**HANDLES FOR ROOT ELEVATORS POINTS
A, B, C, D**

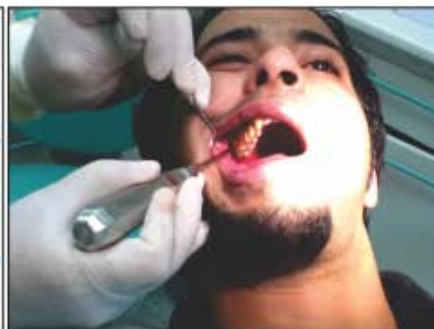
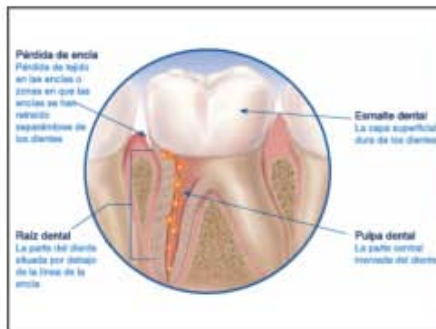

ROOT ELEVATOR



- Элеватор корневой экстракционный
- Elévateurs à racines
- Wurzelheber
- Слеватор корневий екстракційний
- Elevadores para raices
- المصاعد الجذر

Apexo Root Elevators



Apexo



DE-150
Apexo
2.5x9mm
Straight



DE-151
Apexo
2.7x9mm
Straight



DE-152
Apexo
3.0x9mm
Straight



DE-153
Apexo
2.5x9mm
Curved



DE-154
Apexo
3.0x9mm
Curved



DE-155
Seldin
3.0x14mm
Straight

Luxator Root Elevators



Luxator



DE-156
Luxator
3mm
straight



DE-157
Luxator
3mm
curved



DE-158
Luxator
4mm
straight



DE-159
Luxator
4mm
curved



DE-160
Luxator
5mm
straight



DE-161
Luxator
5mm
curved

Bein Root Elevators



Bein



DE-162
Bein 2mm



DE-163
Bein 3mm



DE-164
Bein 4mm

Seldin Root Elevators



Seldin



DE-165
Flohr 1



DE-166
Seldin 34S



DE-167
Seldin 34





- Элеватор корневой экстракционный
- Elévateurs à racines
- Wurzelheber
- Слеватор корневий екстракційний
- Elevadores para raices
- المصاعد الجذر

Apexo Root Elevators



Apexo



DE-168
Apexo
2.5x9mm
Straight



DE-169
Apexo
2.7x9mm
Straight



DE-170
Apexo
3.0x9mm
Straight



DE-171
Apexo
2.5x9mm
Curved



DE-172
Apexo
3.0x9mm
Curved



DE-173
Seldin
3.0x14mm
Straight

Luxator Root Elevators



Luxator



DE-174
Luxator
3mm
straight



DE-175
Luxator
3mm
curved



DE-176
Luxator
4mm
straight



DE-177
Luxator
4mm
curved



DE-178
Luxator
5mm
straight



DE-179
Luxator
5mm
curved

Bein Root Elevators



Bein



DE-180
Bein 2mm



DE-181
Bein 3mm



DE-182
Bein 4mm

Seldin Root Elevators



Seldin



DE-183
Flohr 1



DE-184
Seldin 34S



DE-185
Seldin 34



ROOT ELEVATOR



- Элеватор корневой экстракционный
- Elévateurs à racines
- Wurzelheber
- Слеватор корневий экстракційний
- Elevadores para raices
- المعساعد الجذر

Apical Root Elevators

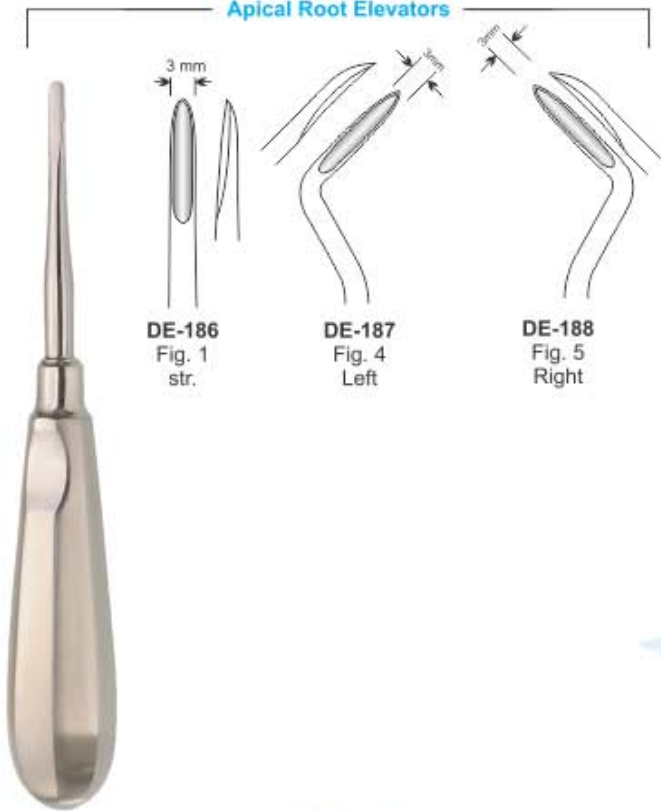

Apical Root Elevators

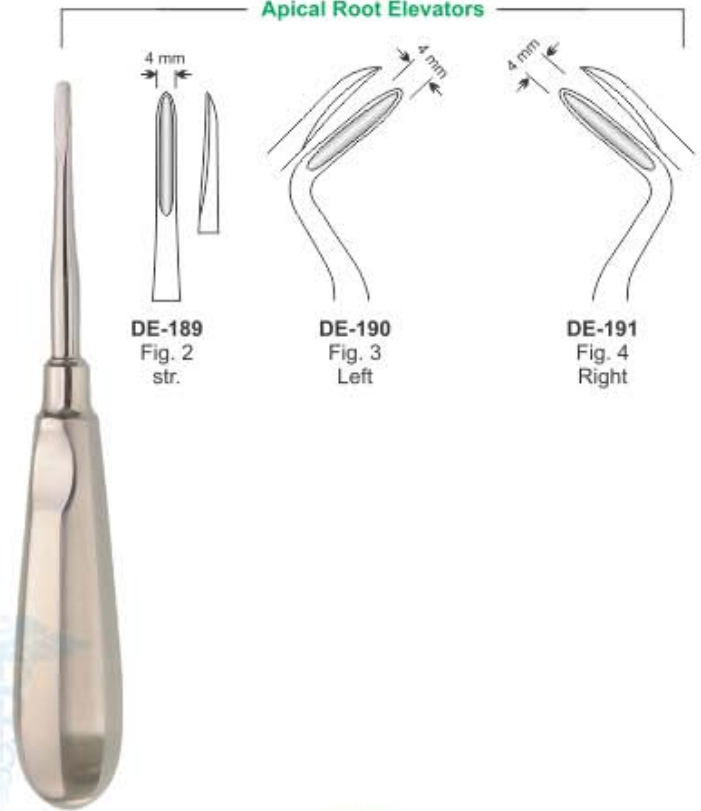

Coupland Root Elevators

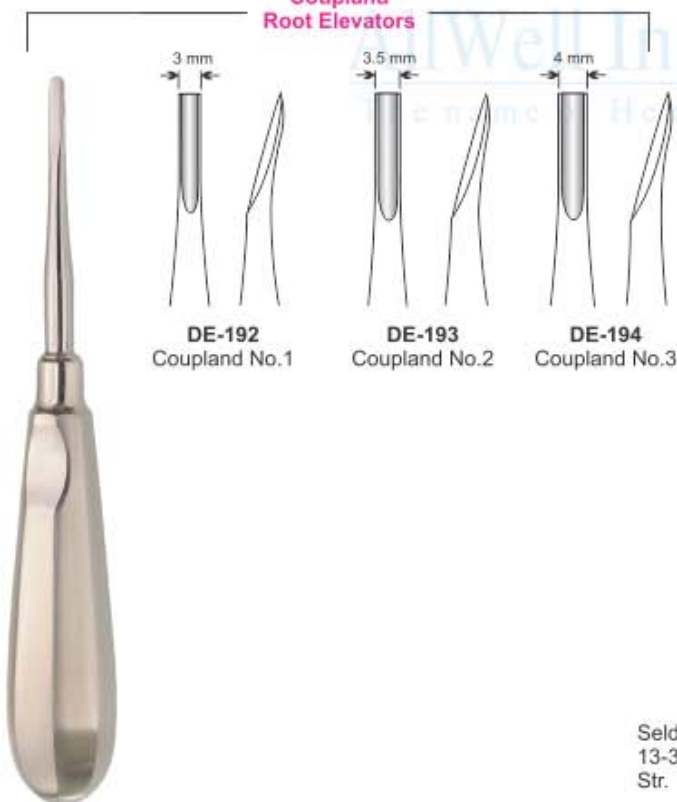

Seldin Root Elevators

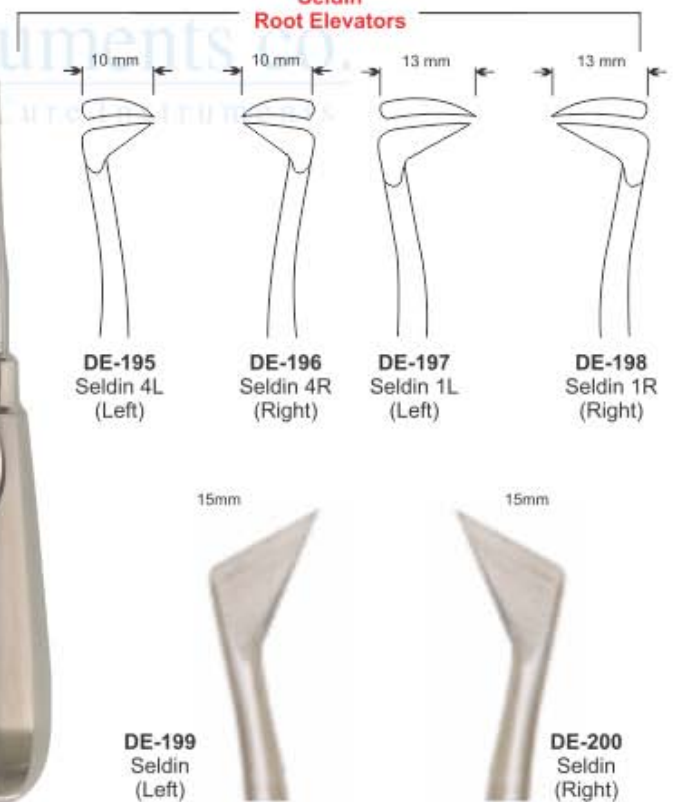



- Элеватор корневой экстракционный
- Elévateurs à racines
- Wurzelheber

- Слеватор корневий екстракційний
- Elevadores para raices
- المصاعد الجذر

Apical Root Elevators

Apical Root Elevators

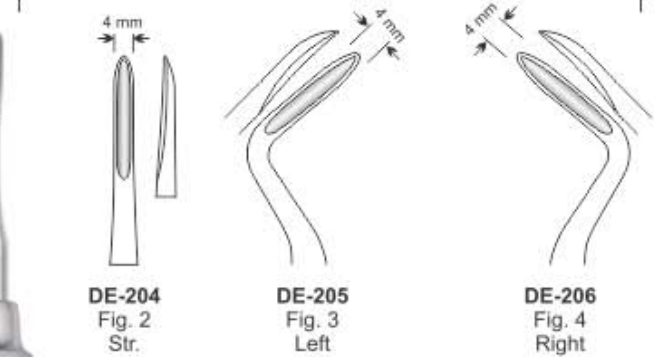
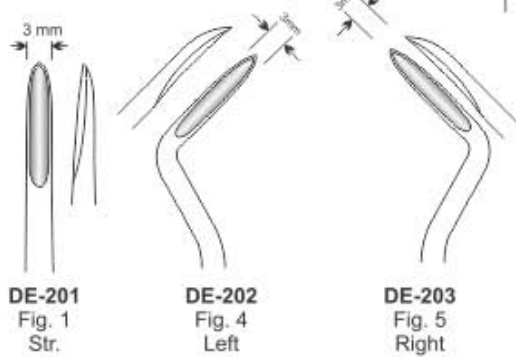

DE-201
Fig. 1
Str.

DE-202
Fig. 4
Left

DE-203
Fig. 5
Right

DE-204
Fig. 2
Str.

DE-205
Fig. 3
Left

DE-206
Fig. 4
Right

Coupland
Root Elevators

Seldin
Root Elevators

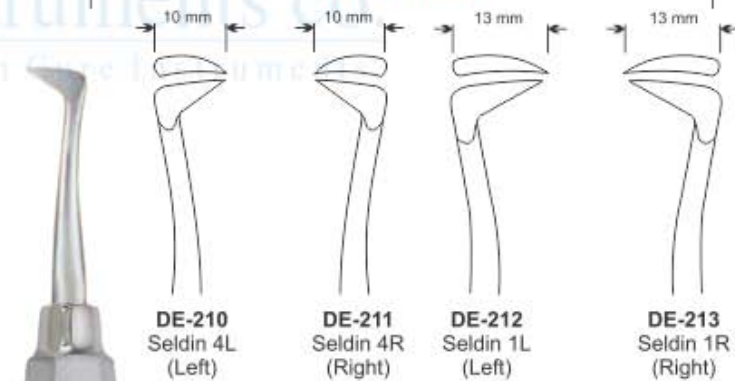
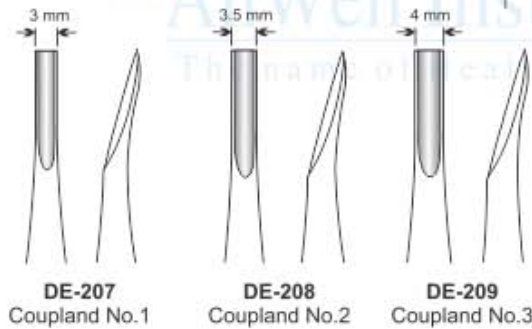

DE-207
Coupland No.1

DE-208
Coupland No.2

DE-209
Coupland No.3

DE-210
Seldin 4L
(Left)

DE-211
Seldin 4R
(Right)

DE-212
Seldin 1L
(Left)

DE-213
Seldin 1R
(Right)

Coupland

Seldin
13-3
Str.



DE-215
Seldin
(Left)

DE-215
Seldin
(Right)



ROOT ELEVATOR



- Элеватор корневой экстракционный
- Elévateurs à racines
- Wurzelheber
- Слеватор корневий екстракційний
- Elevadores para raices
- المعاعد الجذر

Apical Root Elevators

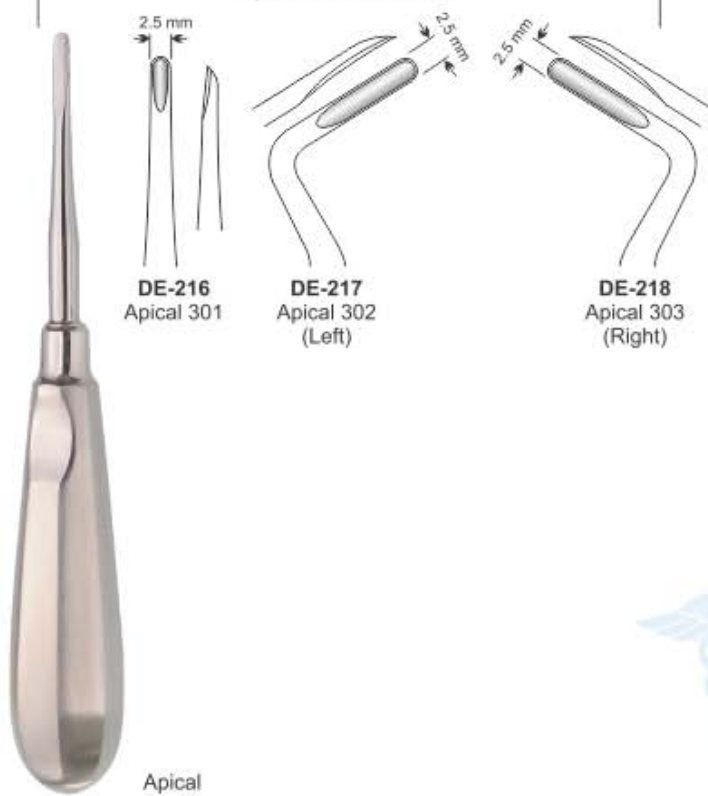

Apical Root Elevators

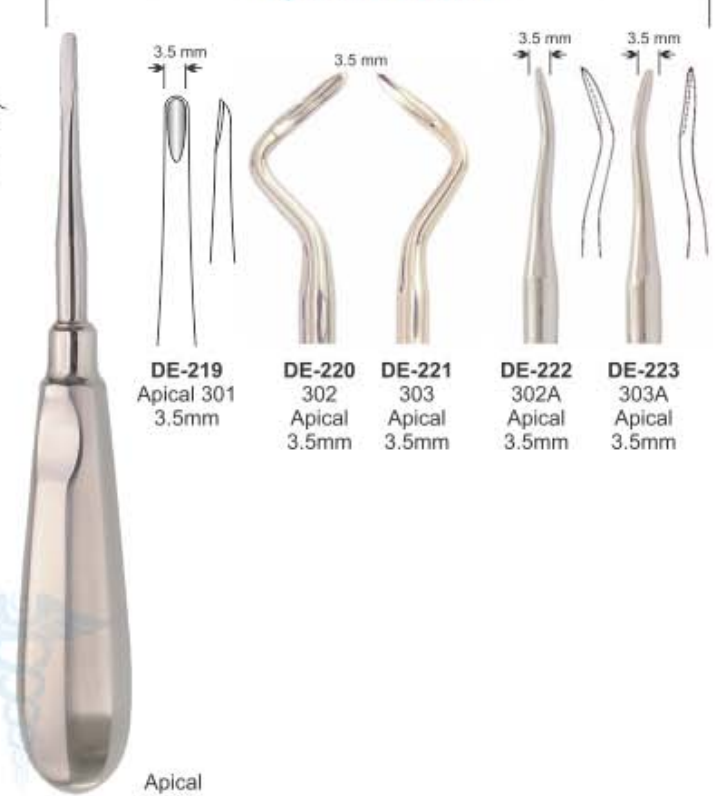

Apical Root Elevators



Laxutor Root Elevators





- Элеватор корневой экстракционный
- Elévateurs à racines
- Wurzelheber

- Elevator corneviu extracționiu
- Elevadores para raices
- المصاعد الجذر

Lindo Levian Root Elevators

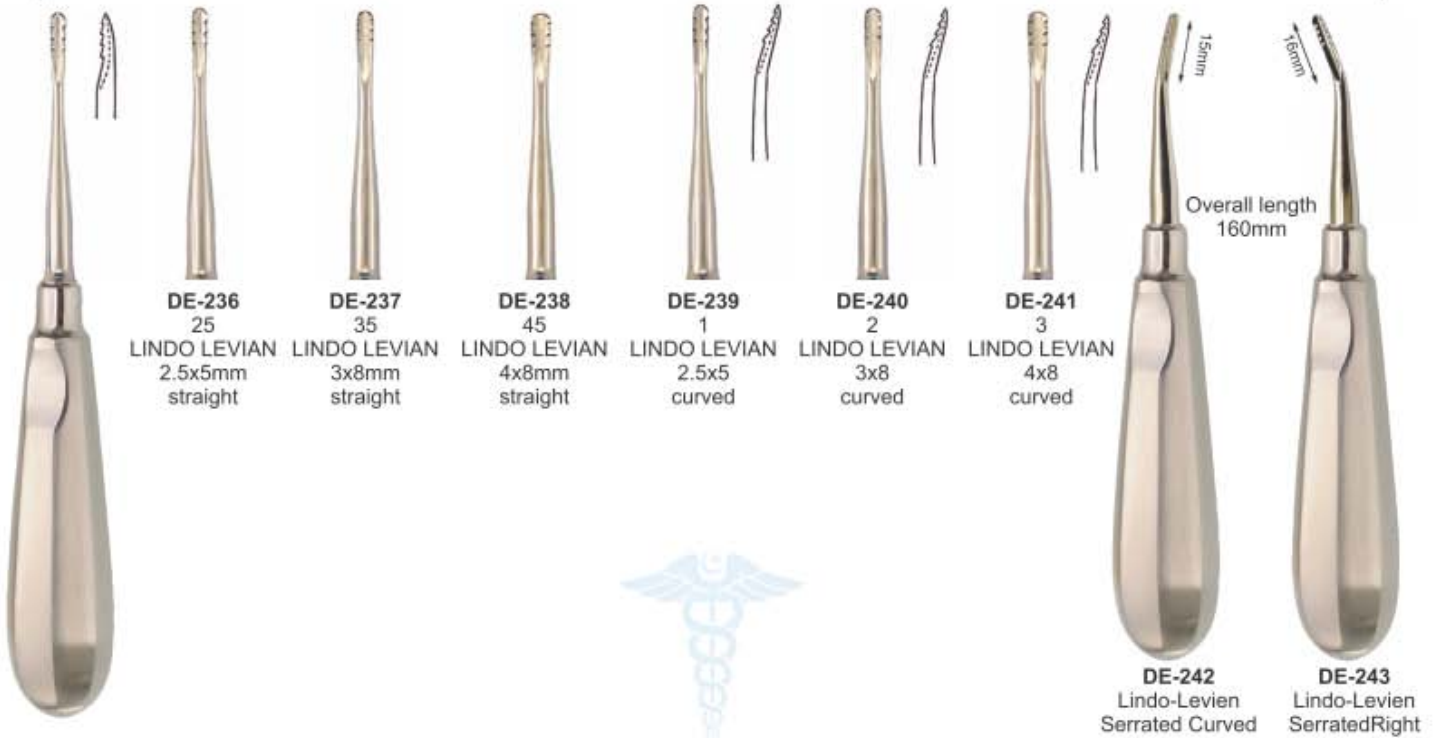

Flohr Root Elevators

Heidbrink Root Elevators

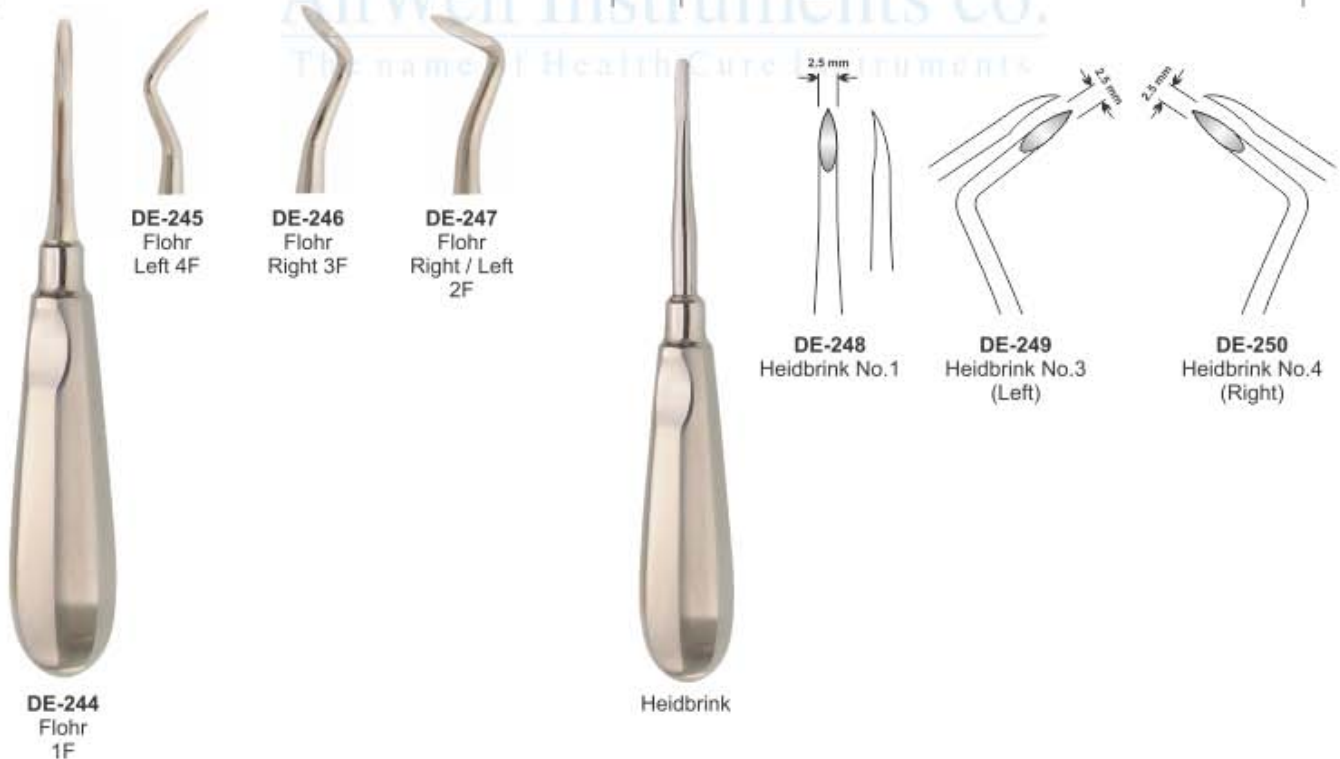

ROOT ELEVATOR



- Элеватор корневой экстракционный
- Elévateurs à racines
- Wurzelheber
- Слеватор корневий екстракційний
- Elevadores para raices
- المصاعد الجذر

Friedmann Roots Elevator



DE-251 Friedmann 4F Str.
DE-252 Friedmann 5F Left
DE-253 Friedmann 6F Right

Heidbrink Roots Elevator



DE-254 Heidbrink Straight
DE-255 Heidbrink Left
DE-256 Heidbrink Right

Wisdom Roots Elevator



DE-257 Wisdom for 18 and 38
DE-258 Wisdom for 28 and 48

Bayonet Roots Elevator Set



DE-259 Left
DE-260 Right
DE-261 bayonet
DE-262 Curved
DE-263 Straight

Luxator Roots Elevator



DE-264 Luxator Straight
DE-265 Luxator Curved





- Элеватор корневой экстракционный
- Elévateurs à racines
- Wurzelheber
- Слеватор корневий екстракційний
- Elevadores para raices
- المصاعد الجذر

Roots Elevator

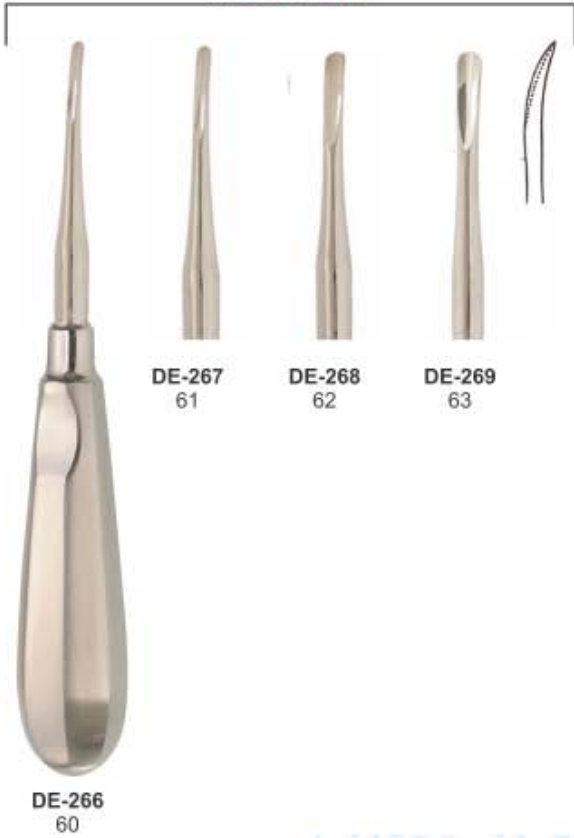

Luxier Roots Elevator



Luxier Roots Elevator

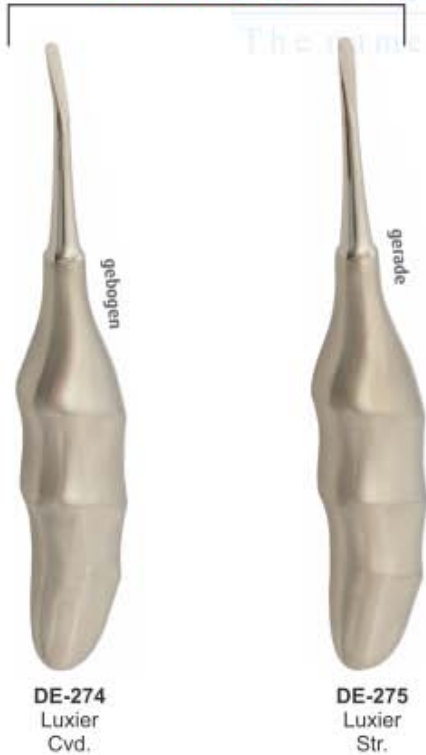

Claw-Lift Roots Elevator



ROOT ELEVATOR



- Элеватор корневой экстракционный
- Elévateurs à racines
- Wurzelheber
- Слеватор корневий экстракційний
- Elevadores para raices
- المصاعد الجذر

Hyllin Roots Elevator

Cryer Roots Elevator



Kopp Roots Elevator

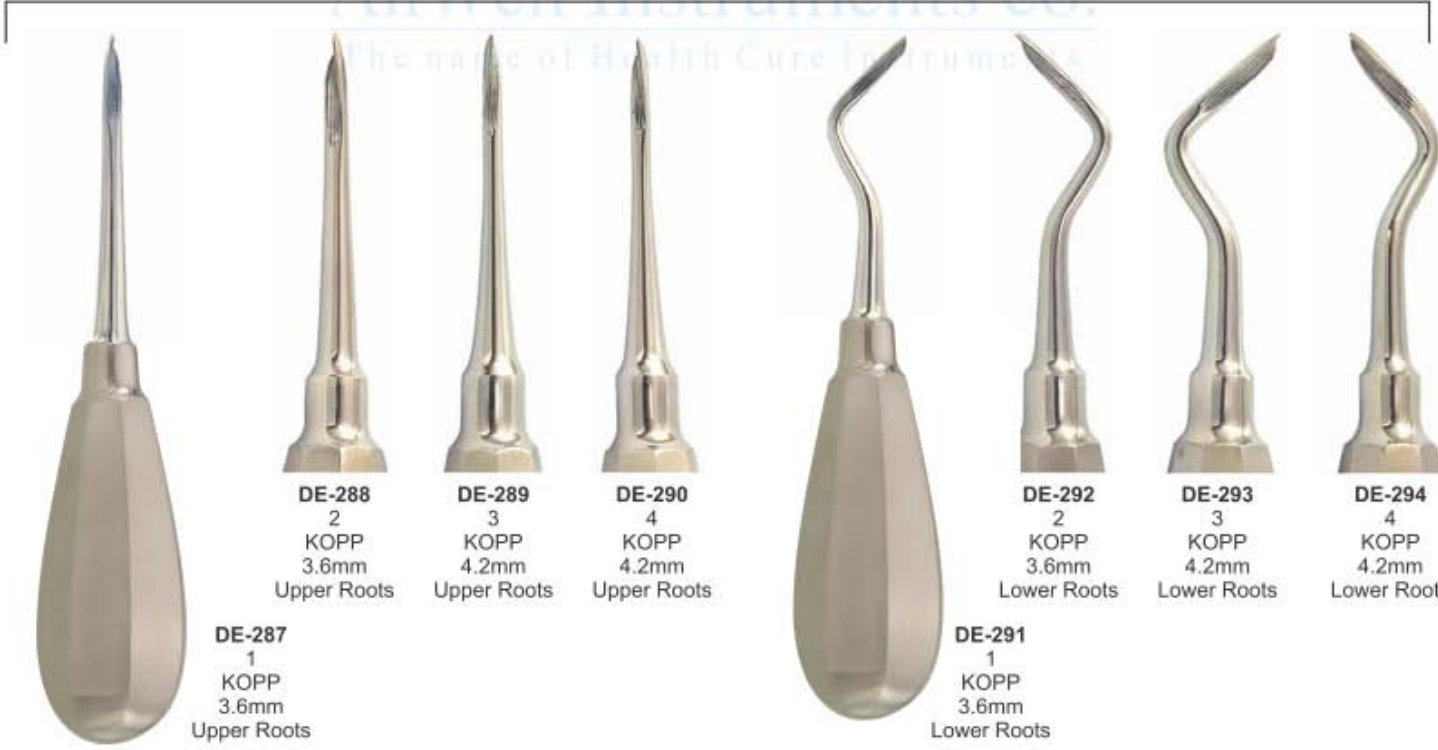



- Элеватор корневой экстракционный
- Élévateurs à racines
- Wurzelheber

- Слеватор корневий екстракційний
- Elevadores para raices
- المعصاع الجذر

Kopp Roots Elevator



DE-295
Kopp
Right

DE-296
Kopp
Left

Heber Roots Elevator



DE-297
Heber
Bayonet

DE-298
Heber
Bayonet

Bein Roots Elevator



DE-299
Bein,
3mm

DE-300
Bein,
4mm

Bein Roots Elevator



DE-302
2mm
straight
serrated

DE-303
3mm
straight

DE-304
4mm
Curved

DE-306
2mm
straight
serrated

DE-307
3mm
straight

DE-308
4mm
Curved

DE-310
2mm
straight
serrated

DE-311
3mm
straight

DE-312
4mm
Curved

DE-301
Bein
2mm, curved
serrated

DE-305
Bein
2mm, curved
serrated

DE-309
Bein
2mm, curved
serrated



ROOT ELEVATOR



- Элеватор корневой экстракционный
- Слеватор корневий екстракційний
- Elévateurs à racines
- Elevadores para raices
- Wurzelheber
- المصاعد الجذر

Seldin Roots Elevator



W. Barry Roots Elevator



Winter Roots Elevator



Pott Roots Elevator





- Элеватор корневой экстракционный
- Elévateurs à racines
- Wurzelheber

- Elevator cornevia extraccionnyy
- Elevadores para raices
- المصاعد الجذر

Heidbrink Roots Elevator



DE-338
Heidbrink
Straight

DE-339
Heidbrink
Left

DE-340
Heidbrink
Right

DE-341
Heidbrink
Straight

DE-342
Heidbrink
Left

DE-343
Heidbrink
Right

Syndesmotomes Roots Elevator



DE-344
Straight

DE-345
Left

DE-346
Right

Periotome Roots Elevator

Syndesmotomes



DE-347
Periotome
2.1mm
Straight

DE-348
Periotome
2.6mm
Straight

DE-349
Periotome
2.1mm
Angular

DE-350
Periotome
2mm
Curved

DE-351
Periotome
2.0mm

DE-352
Periotome
2.5mm

DE-353
Periotome
3.0mm

DE-354
Periotome
4.0mm



ROOT ELEVATOR



- Элеватор корневой экстракционный
- Elévateurs à racines
- Wurzelheber
- Слеватор корневий екстракційний
- Elevadores para raices
- المصاعد الجذر



DE-355
1S
(Straight 1mm)



DE-356
2S
(Straight 2mm)



DE-357
3S
(Straight 3mm)



DE-358
5S
(Straight 5mm)



DE-359
3C
(Curved 3mm)



DE-360
5C
(Curved 5mm)



DE-361
3CA
(Curved Angle 3mm)



DE-362
3IC
(Inverted Curved 3mm)



DE-363
DE 3
(Dual Edge 3mm / 1.5mm)



DE-364
DE 5
(Dual Edge 5mm / 3mm)





- Элеватор корневой экстракционный
 - **Élévateurs à racines**
 - Wurzelheber
- PDL ELEVATORS**

- Слеватор корневий екстракційний
- Elevadores para raices
- المصاعد الجذر

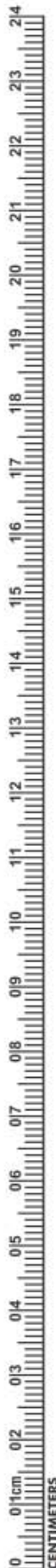

DE-365
PDL Elevators
Set of 7 Pcs

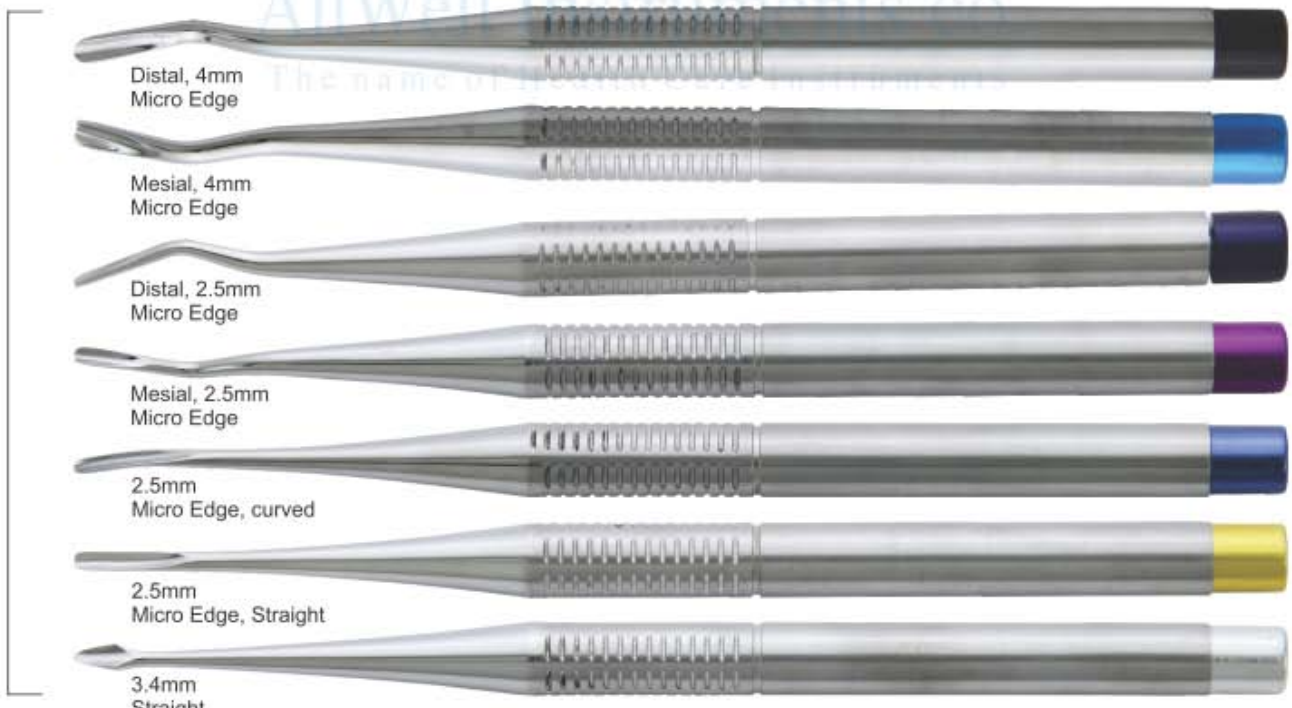

DE-366
PDL Elevators
Set of 7 Pcs

ROOT ELEVATOR

- Элеватор корневой экстракционный
- Elévateurs à racines
- Wurzelheber
- Слеватор корневий екстракційний
- Elevadores para raices
- المصاعد الجذر

AllWell Instruments co.
The name of Health Care Instruments



PDL ELEVATORS

Delicate Arrow tip



4,0mm straight
4,0mm curved

Luxivators straight
atraumatic luxation of the tooth



2,5mm straight
3,5mm straight
4,5mm straight

Luxivators curved
atraumatic luxation of the tooth



2,5mm curved
3,5mm curved
4,5mm curved



DE-367
PDL Elevators
Set of 8 Pcs





Our Scalers

Compare our scalers and curettes with the best in the industry and you will immediately recognize we are equal in every way but one... price. Note the deep precision knurling for better tactile feel. The same high-grade stainless steel tips, the same light weight (under 18 grams) for less hand fatigue, the same professional craftsmanship, and surpassing the highest industry standards. of course, any manufacturer can make these claims, but we guarantee and certify ours.

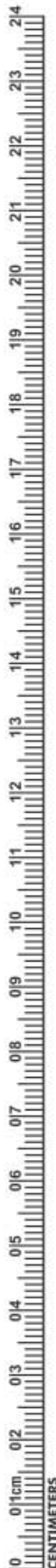

Healthy

Healthy Gums

Healthy Attachment and Bone Levels

Periodontal Disease

Periodontal Prob

Plaque Bacteria Biofilm

Calculus / Tartar

Periodontal Pocke

Reduced Attachmen and Bone Level

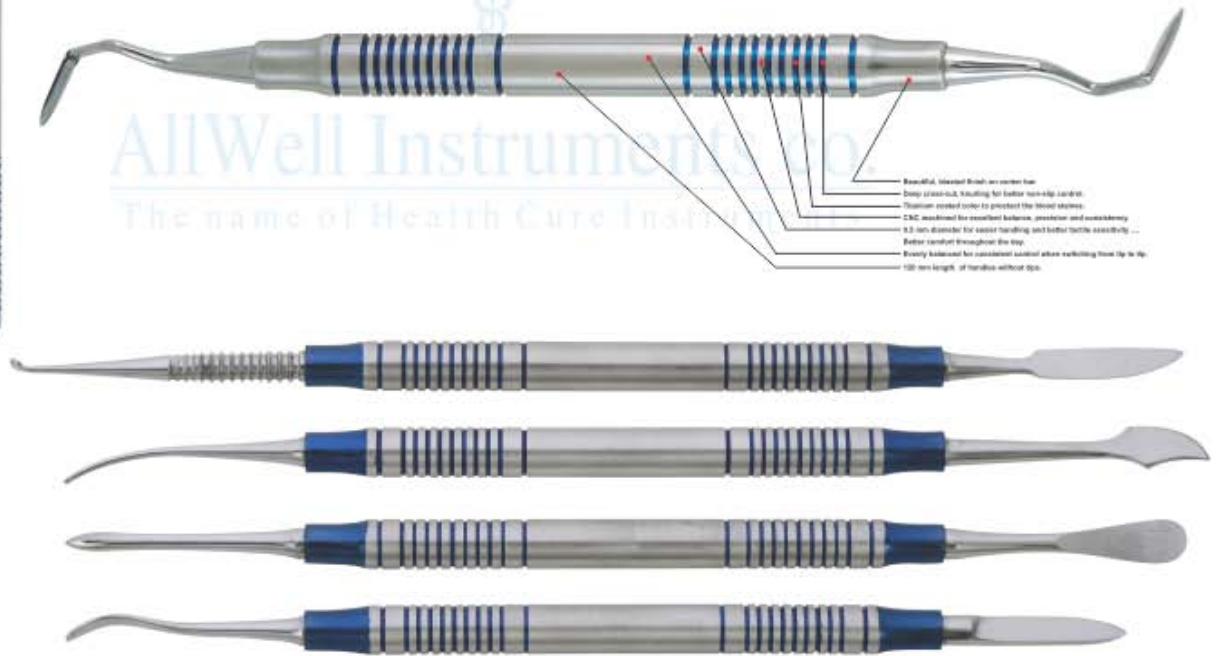
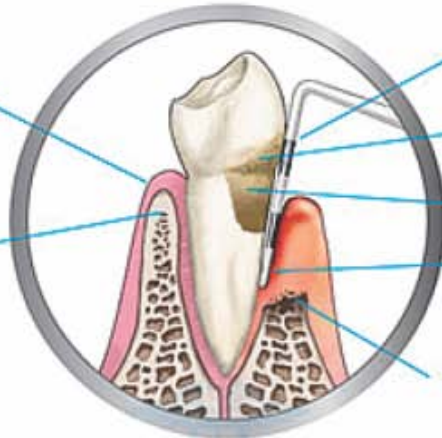

- Beautiful, blended finish on entire tool
- Deep groove-knurling for better non-slip control
- Titanium coated body to protect the blood stream
- CNC machined for excellent balance, precision and consistency
- 2.0 mm diameter for easier handling and better tactile sensitivity ...
- Better comfort throughout the tip
- Every balanced for consistent control when working from tip to tip
- 100 mm length of handle without tips

- High-polish mirror finish tips.
- Manufactured within the guidelines of the FDA quality assurance system for good manufacturing practices.
- Highest grade German stainless steel, razor sharp, durable tips. Rockwell hardened to 60 RHc.
- 27 of the most popular designs from graceys to McCalls to columbias, and many european patterns.
- All instruments are guaranteed against defects in material and workmanship.

- All instruments bear the ce mark, emblematic of the european community's highest standards.
- Customer satisfaction guarantee, tool
- Less than 20 grams ... Lightweight for less hand fatigue.
- Manufactured to the most exacting standards so the 50th instrument you buy is exactly like your first.
- You decide ... Why pay more for the same high-quality instruments?

HANDLES FOR MOUTH MIRRORS



- Ручки для зеркал
- Manches pour miroirs à bouche
- Mundspiegelgriffe
- Ручки для дзеркал
- Mangos para espejos de boca
- مقابض لمرآيا الفم



Magnifying

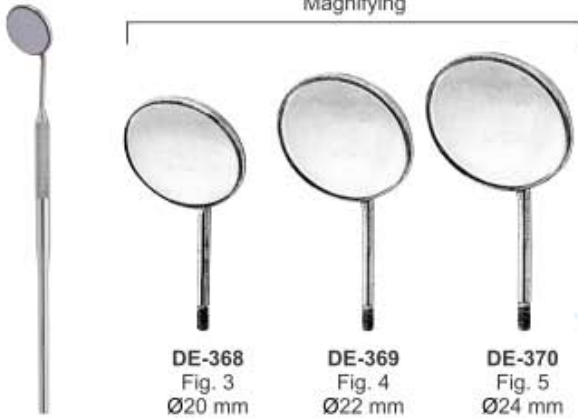

Plain

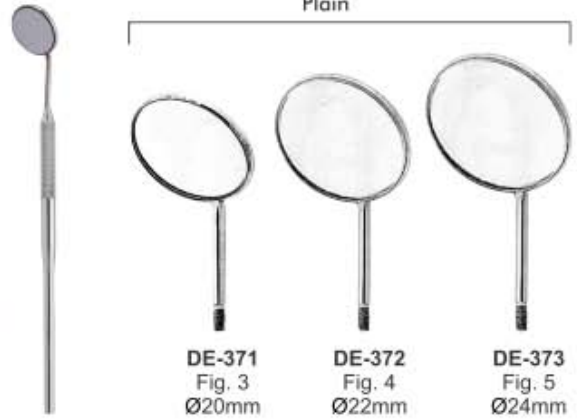

Rhodium

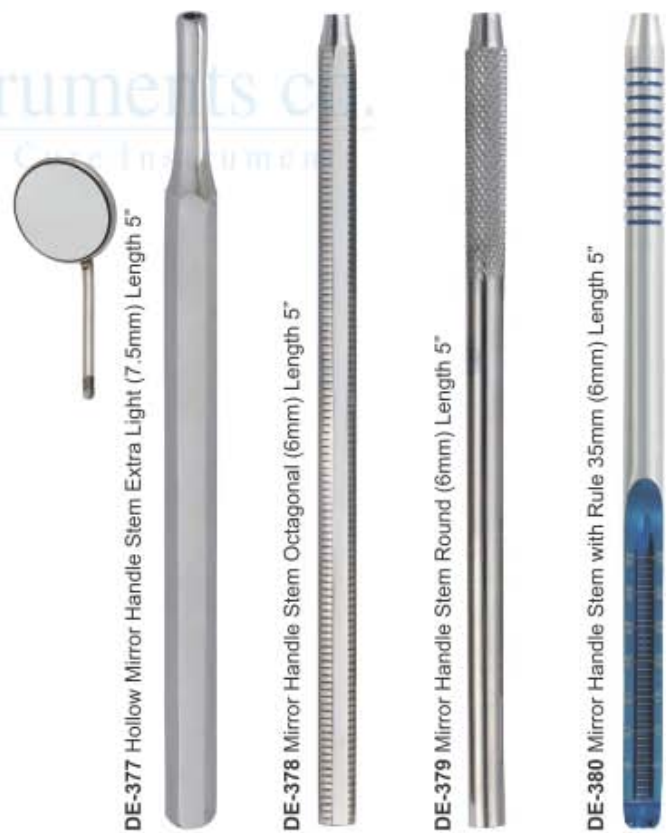
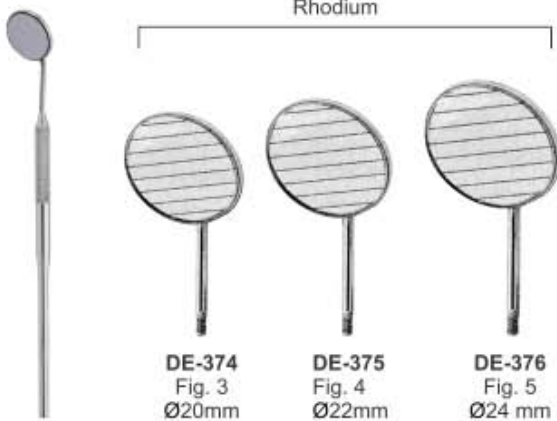



- Пинцеты
- Pinceltes - Brucelles
- Zahnpinzetten

- Пинцети
- Pinzas para algodón
- ملاقط



DE-381
Surgical
11.5cm



DE-382
London College
15cm



DE-383
Semken Taylor
Str.



DE-384
Semken Taylor
Cvd.



DE-385
Meriam
16cm



DE-386
Dressing
14cm



DE-387
Semken Taylor
1x2 Straight



DE-388
Semken Taylor
1x2 Curved



DE-389
Gilles
15cm 1x2



DE-390
14cm 1x2



DE-391
Perry
13cm



DE-392
Atraumatic
15cm Cvd



DE-393
Atraumatic
15cm Str.



DE-394
College with Lock
15cm Cvd.



DE-395
Gerald
17.5cm



DE-396
with lock
15cm



DE-397
Atraumatic
17.5cm



TWEEZERS



- Пинцеты
- Pincettes - Brucelles
- Zahnpinzetten

- Пинцети
- Pinzas para algodón
- ملاقط



DE-398
Adson-TC
12cm



DE-399
Adson-TC
12cm 1x2



DE-400
Adson-TC
15cm 1x2



DE-401
Adson
12cm



DE-402
Adson
12cm 1x2



DE-403
Adson
15cm 1x2



DE-404
Adson Brown
12cm



DE-405
Crane Kaplan
15cm



DE-406
Crane Kaplan
15cm



DE-407
Crane Kaplan
15cm



DE-408
Hemingway
15cm



DE-409
Miller
15cm Str.



DE-410
Miller
15cm Cvd.



DE-411
Dressing
Tweezer
14.5cm



DE-412
College
Curved
Tip 15cm



DE-413
Maryam
Tweezers
15cm



DE-414
College
Tweezer
15cm



DE-415
Perry
Tweezer
12.5cm



DE-416
Self-locking
Tweezer
15cm





- Зонды
- Sondes
- Zahnsonden
- Зонди
- Sondas
- المستكشفين

Single Ended Probe Solid Handle 4.5mm Length 150mm



Fig. 2
Normal Handle

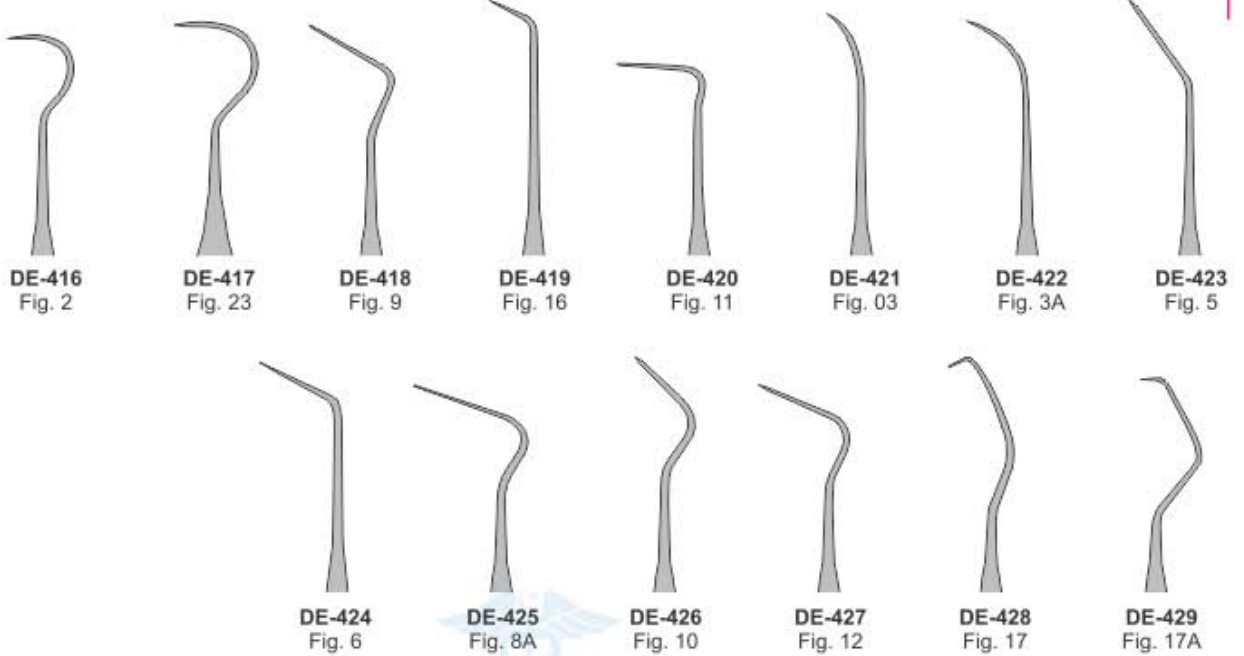

Single Ended Probe Hollow Handle 8.5mm Length 150mm



Fig. 2
Anatomic Handle

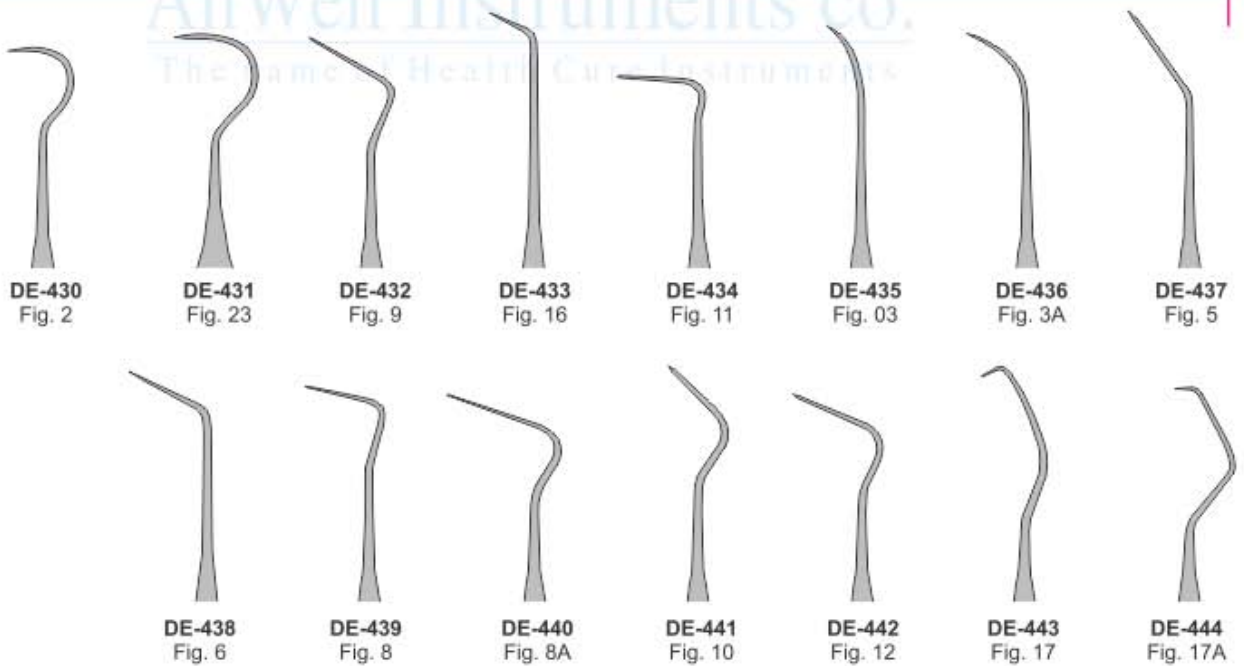

EXPLORERS



- Зонды
- Sondes
- Zahnsonden
- Зонди
- Sondas
- المستكشفين

Probes Single End Solid Handle 6mm, length 150mm



DE-445 Fig. 6 DE-446 Fig. 8 DE-447 Fig. 9 DE-448 Fig. 16 DE-449 Fig. 23

Probes Single Ended 6mm, length 150mm

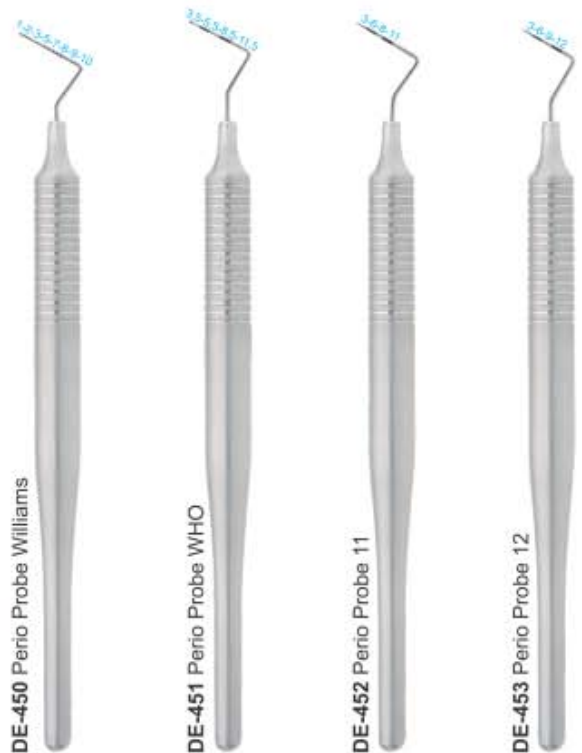

DE-450 Perio Probe Williams DE-451 Perio Probe WHO DE-452 Perio Probe 11 DE-453 Perio Probe 12

Examination kit Set of 3 Pieces



DE-454 Probe DE-455 Mirror DE-456 College Forcep 15cm

Examination Set of 4 Pieces



Examination Set of 4 Pieces



DE-457 Exp,23/17-A DE-458 Exavators DE-459 Tweezers DE-460 Mouth Mirror





- Зонды
 - Sondes
 - Zahnsonden
- Зонди
 - Sondas
 - المستكشفين

**EXPLORERS INSTRUMENTS
SOLID HANDLE 6MM, LENGTH 170MM**

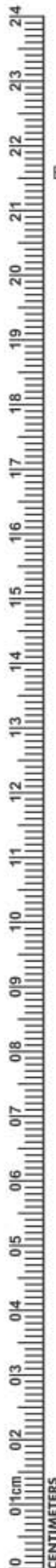

Explorers-Single-End



DE-461
23
Shepherd's
Hook
Explorer
#30, #6, #7, #8

Double-Ended Explorers



Tip Size: 1/1
Solid Handle Size 4.25"

DE-462
#5, #6
Explorer

EXPLORERS

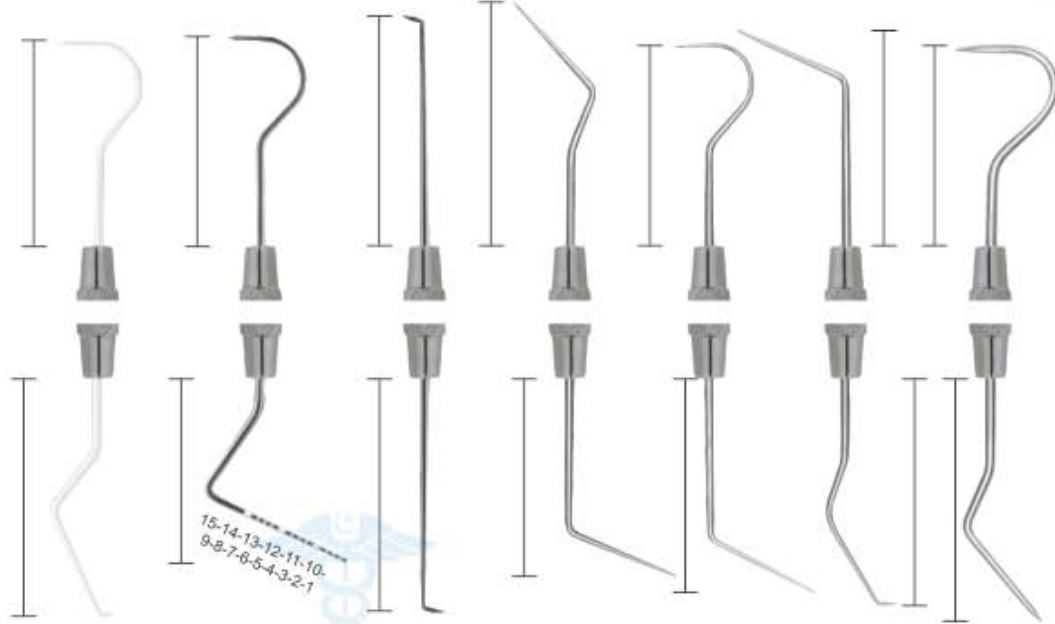

15-14-13-12-11-10
9-8-7-6-5-4-3-2-1

DE-463
TU 17/23
Wilkins/Tufts
Explorer
#6

DE-464
23/UNC1
university of north
carolina
Explorer #31, #6, #7, #8

DE-465
1
#31, #6

DE-466
DG 16
#31, #6, #7
Thick, #6

DE-467
DG 16/23

DE-468
DG 16/17

DE-469
1
Abou-Rass
Explorers

Probes Double Ended 6mm, length 170mm



DE-470
Goldman Fox
Fig.17

DE-471
University
of Michigan
Fig.17

DE-472
Williams
Fig.17

DE-473
Goldman Fox
Fig.16

DE-474
University
of Michigan
Fig.16

DE-475
Williams
Fig.16

EXPLORERS



- Зонды
- Sondes
- Zahnsonden
- Зонди
- Sondas
- المستكشفين

Pointed Probes Single Ended Handle 6mm, length 150mm

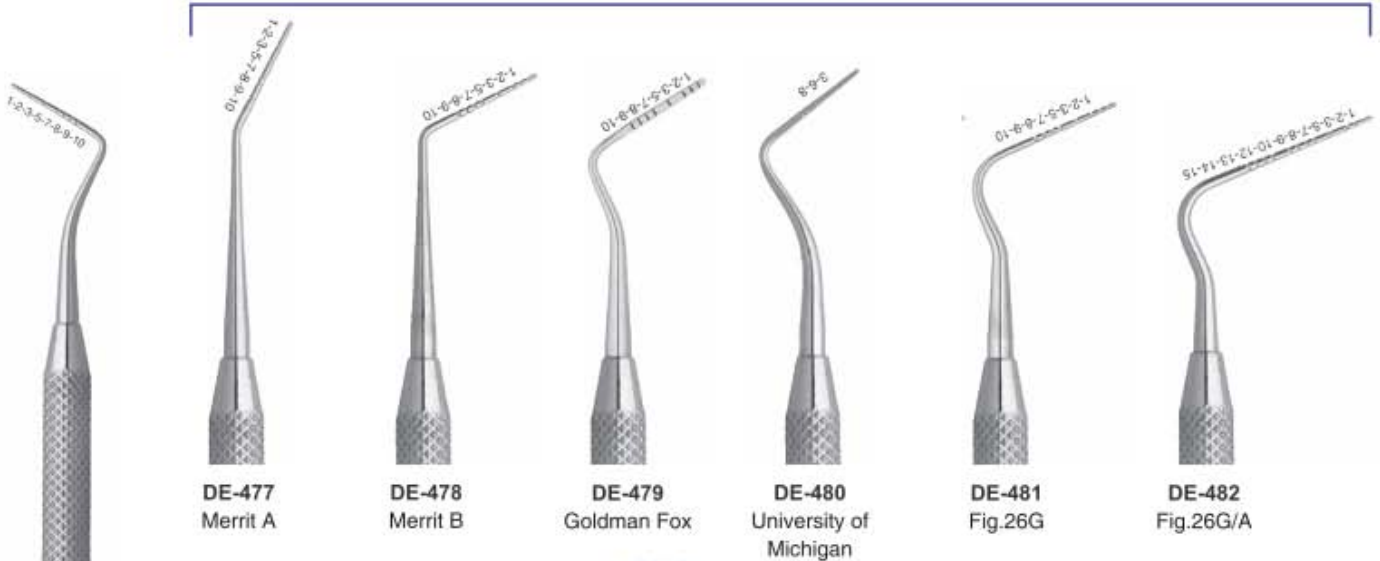

Pointed Probes Double Ended Handle 6mm, length 170mm





- Инструменты пародонтологические
- Instruments pour la parodontologie
- Instrumente für die Parodontologie

- Інструменти пародонтологічні
- Instrumentos para periodoncia
- الصكوك اللثة

PERIODONTAL SET OF 10 PIECES SOLID HANDLE 6MM LENGTH 170MM



EXPLORERS

- Зонды
- Sondes
- Zahnsonden
- Зонди
- Sondas
- المستكشفين



WILLIAM PROBE SET DOUBLE ENDED WITH HOLLOW HANDLE 9.5MM, LENGTH 170MM
CERAMIC COATED HANDLE

Proper care must be given during cleaning, sharpening and sterilization to preserve design and integrity and to prolong usefulness. Do not expose instruments to sterilization temperatures above 350 F/177 C or to higher than recommended chemical concentrations.

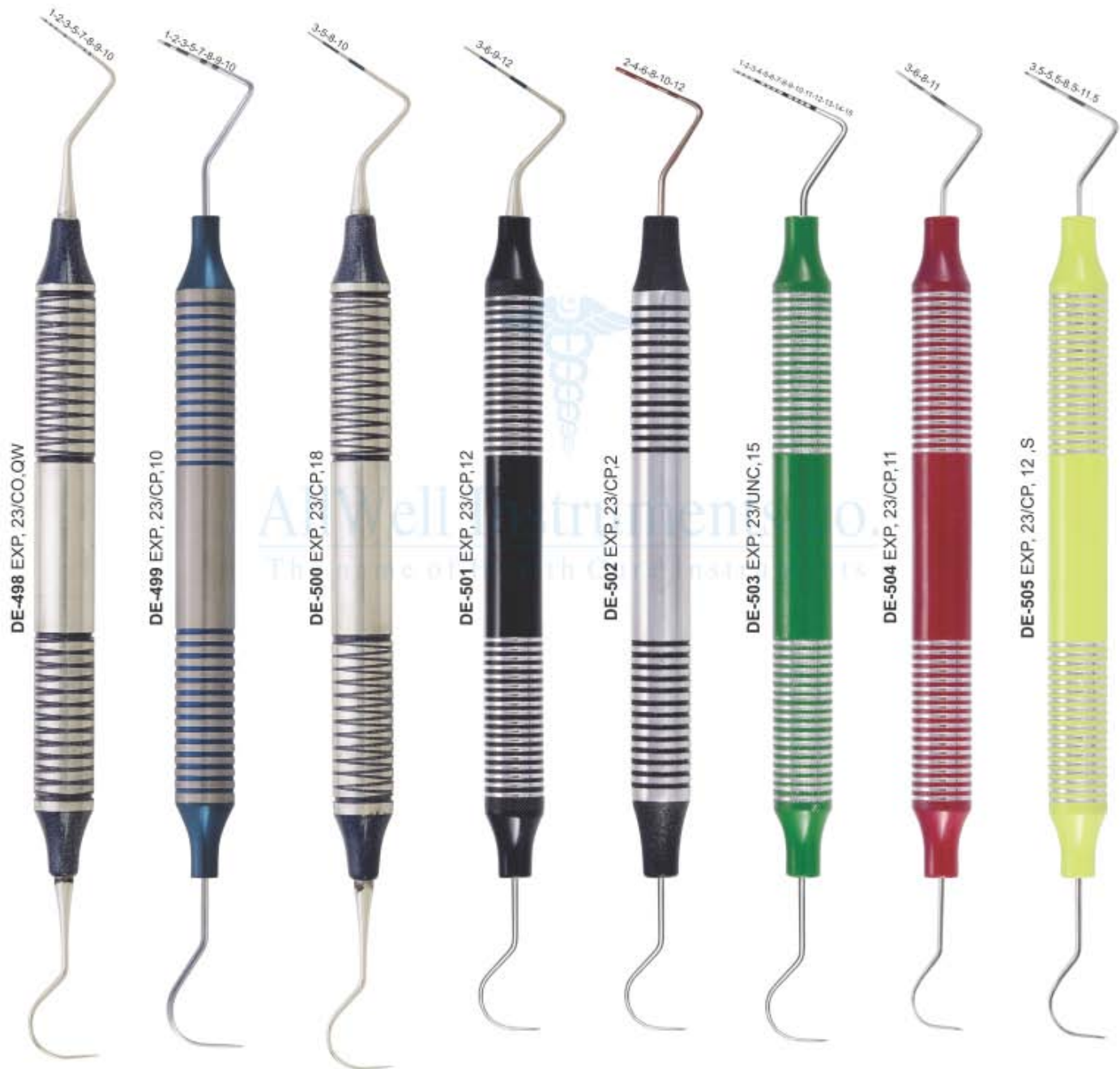

DE-498 EXP, 23/CO,QW

DE-499 EXP, 23/CP,10

DE-500 EXP, 23/CP,18

DE-501 EXP, 23/CP,12

DE-502 EXP, 23/CP,2

DE-503 EXP, 23/JNC,15

DE-504 EXP, 23/CP,11

DE-505 EXP, 23/CP, 12 ,S



- Инструменты пародонтологические
- Instruments pour la parodontologie
- Instrumente für die Parodontologie

- Інструменти пародонтологічні
- Instrumentos para periodoncia
- الصكوك اللثة

**PERIODONTAL INSTRUMENTS SET OF 11 PCS
SOLID HANDLE 6MM, LENGTH 170MM**



DE-506 Tweezer 125mm

125MM



DE-507 Dental Mirror



DE-508 Excavator



DE-509 Heidmann



DE-510 Gracey



DE-511 Filling Ins



DE-512 Hollanback



DE-513 Plugger



DE-514 Sickle



DE-515 Explorer



DE-516 Cutting Ins

CURETTES



- Кюрети
- Curetas
- Küretten
- Кюрети
- Curette
- كرتس

GRACEY SET OF 7 PCS HOLLOW HANDLE 9.5MM, LENGTH 170MM

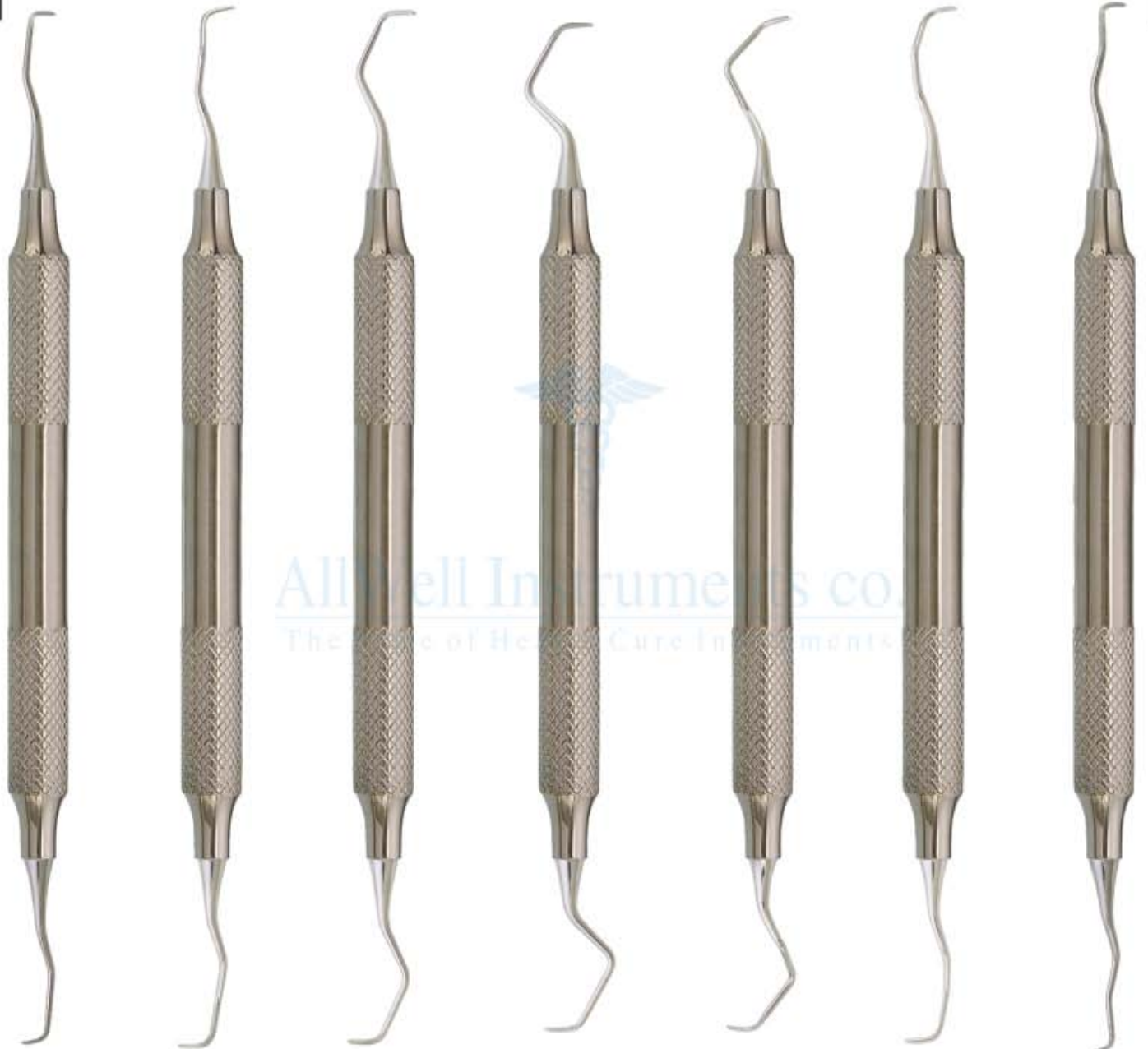

DE-517
GRACEY
1/2

DE-518
GRACEY
3/4

DE-519
GRACEY
5/6

DE-520
GRACEY
7/8

DE-521
GRACEY
9/10

DE-522
GRACEY
11/12

DE-523
GRACEY
13/14



- Кюрети
- Curetas
- Küretten
- Кюрети
- Curette
- کرتس

GRACEY SET OF 7 PCS
HOLLOW HANDLE 9.5MM, LENGTH 170MM WITH SILICON GRIP

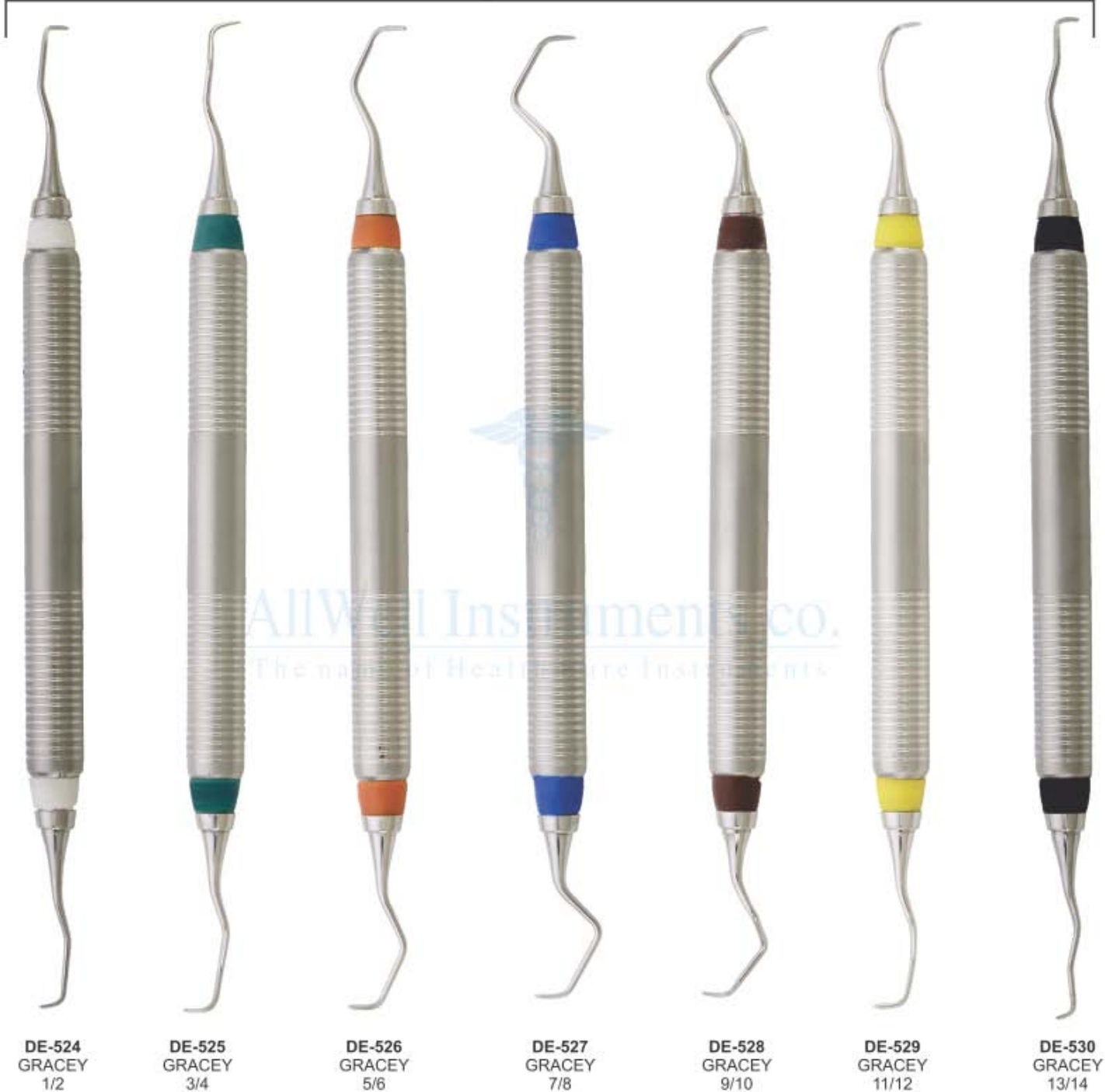
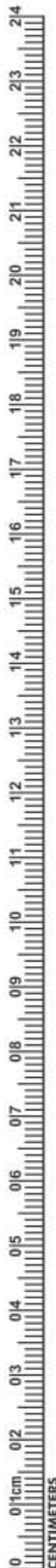

CURETTES



- Кюрети
- Curetas
- Küretten
- Кюрети
- Curette
- كرتس

GRACEY MINI FIVE

HOLLOW HANDLE 9.5MM, LENGTH 170MM
CERAMIC COATED HANDLE



DE-531	DE-532	DE-533	DE-534	DE-535	DE-536
Gracey	Gracey	Gracey	Gracey	Gracey	Gracey
1/2	3/4	5/6	7/8	11/12	13/14

GRACEY AFTER FIVE

HOLLOW HANDLE 9.5MM, LENGTH 170MM
CERAMIC COATED HANDLE



DE-537	DE-538	DE-539	DE-540	DE-541	DE-542
Gracey	Gracey	Gracey	Gracey	Gracey	Gracey
1/2 AF	3/4 AF	5/6 AF	7/8 AF	11/12 AF	13/14 AF

Proper care must be given during cleaning, sharpening and sterilization to preserve design and integrity and to prolong usefulness. Do not expose instruments to sterilization temperatures above 350 F/177 C or to higher than recommended chemical concentrations.





- Кюрети
- Curetas
- Kuretten
- Кюрети
- Curette
- كرتس

GRACEY CURETTE
HOLLOW HANDLE 10MM, LENGTH 170MM

Curetters Set of 8 Pieces



DE-543
Curette
Columbia
2L-2R

DE-544
Curette
Columbia
4L-4R

DE-545
Curette
McCall
13S-14S

DE-546
H6-H7
Scaler
Sickle

DE-547
H5-U15
Scaler
Sickle

DE-548
H5-13
Scaler
Sickle

DE-549
U15-30
Scaler
Sickle

DE-550
U15-33
Scaler
Sickle

FILLING INSTRUMENTS



- Инструменты для реставрации
- Instruments pour plombage
- Füllungsinstrumente (mit Kontrawinkel)
- Инструменти для реставрації
- Instrumentos para obturaciones
- ملء الصكوك

FILLING INSTRUMENTS (Gold Pointed)
SOLID HANDLE 6MM, LENGTH 170MM





**EXPLORERS INSTRUMENTS
SOLID HANDLE 6MM, LENGTH 170MM**

- Зонды
 - Sondes
 - Zahnsonden
- Зонди
 - Sondas
 - المستكشفين

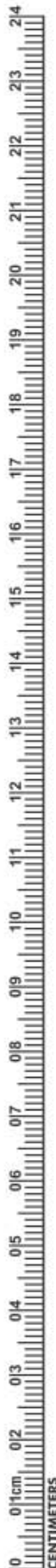

PLUGGERS

 .50 DE-562 5/7 21mm	 1.00 DE-563 9/11 21mm	 .50 DE-564 1/2 Root Canal Plugger	 .80 DE-565 3/4 Root Canal Plugger
 .45 DE-561 1/3 21mm	 .75 DE-566 MA57 27mm	 1.15 DE-567 GP3 30mm	 .20 DE-568 ISO Size 30 24mm
 .30 DE-569 ISO Size 40 24mm	 .40 DE-570 ISO Size 50 24mm	 .50 DE-571 ISO Size 60 24mm	 .25 DE-572 GP3 30mm
 .60 DE-573 ISO Size 60 24mm			

PERIODONTAL PROBES



- Зонды пародонтологические
- Sondes parodontales
- sonda parodontali
- зонди пародонтологічні
- Sondas parodontales
- المسابر اللثة

SPREADERS

HEAT CARRIERS

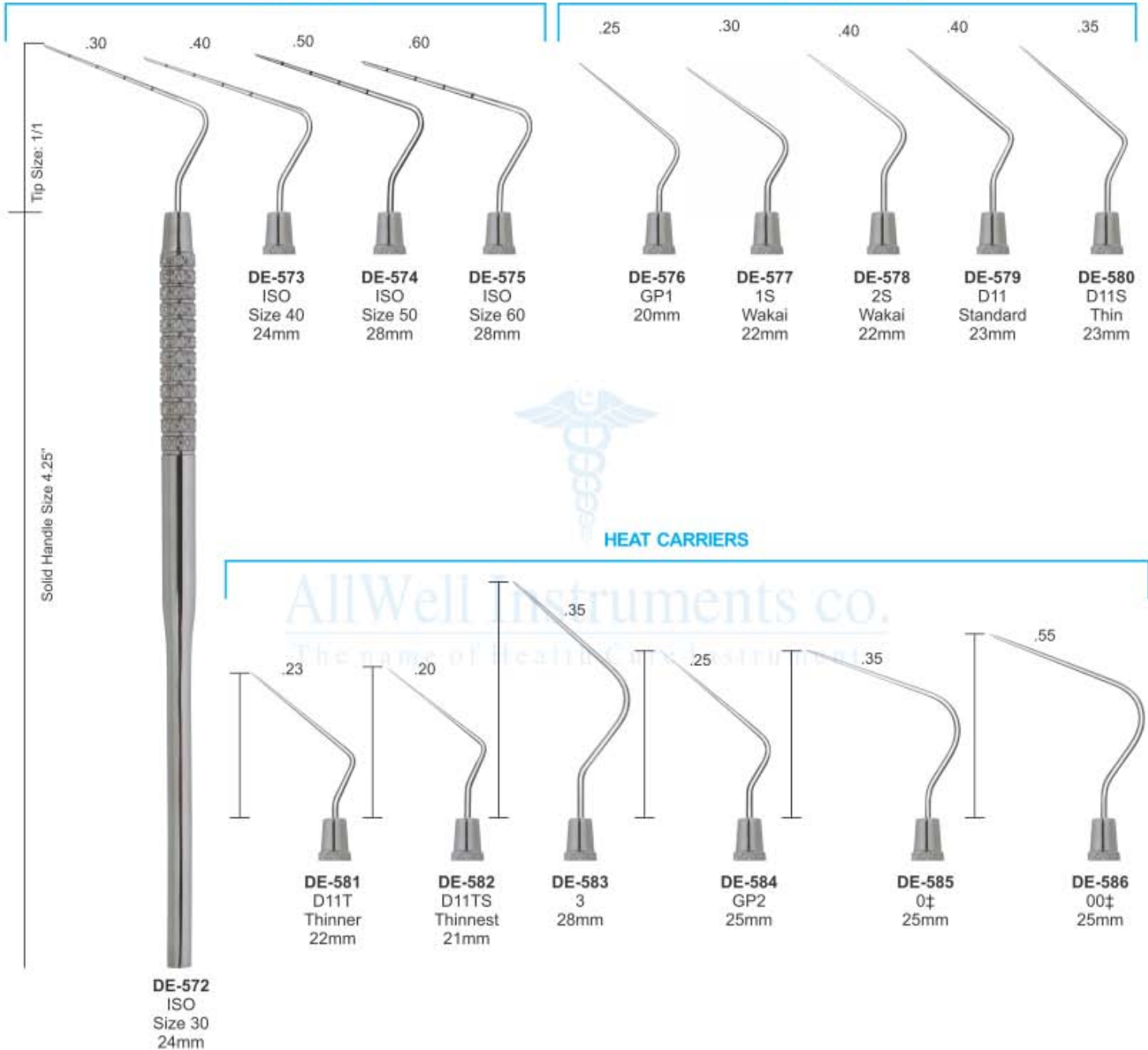

HEAT CARRIERS



- Зонды пародонтологические
 - Sondes paradontales
 - sonda parodontali
- зонди пародонтологічні
 - Sondas paradontales
 - المسابر اللثة

ENDODONTICS INSTRUMENTS

ANTERIOR



LUKS



PERIODONTAL PROBES



- Зонды пародонтологические
- Sondes parodontales
- sonda parodontali
- зонди пародонтологічні
- Sondas parodontales
- المسابر اللثة

ENDODONTICS INSTRUMENTS SOLID HANDLE 6MM, LENGTH 170MM

POSTERIOR

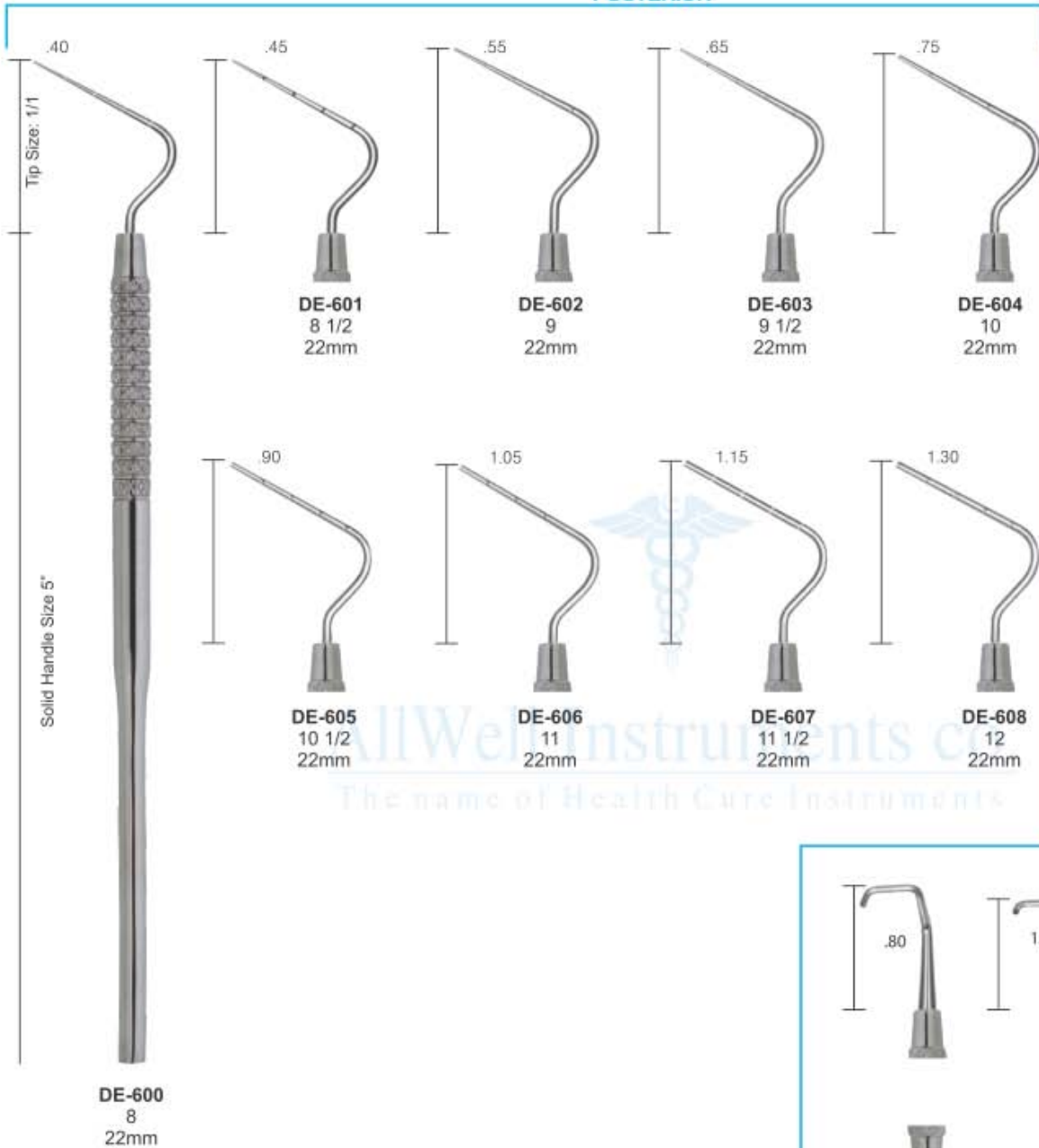

RETRO FILLING PLUGGERS

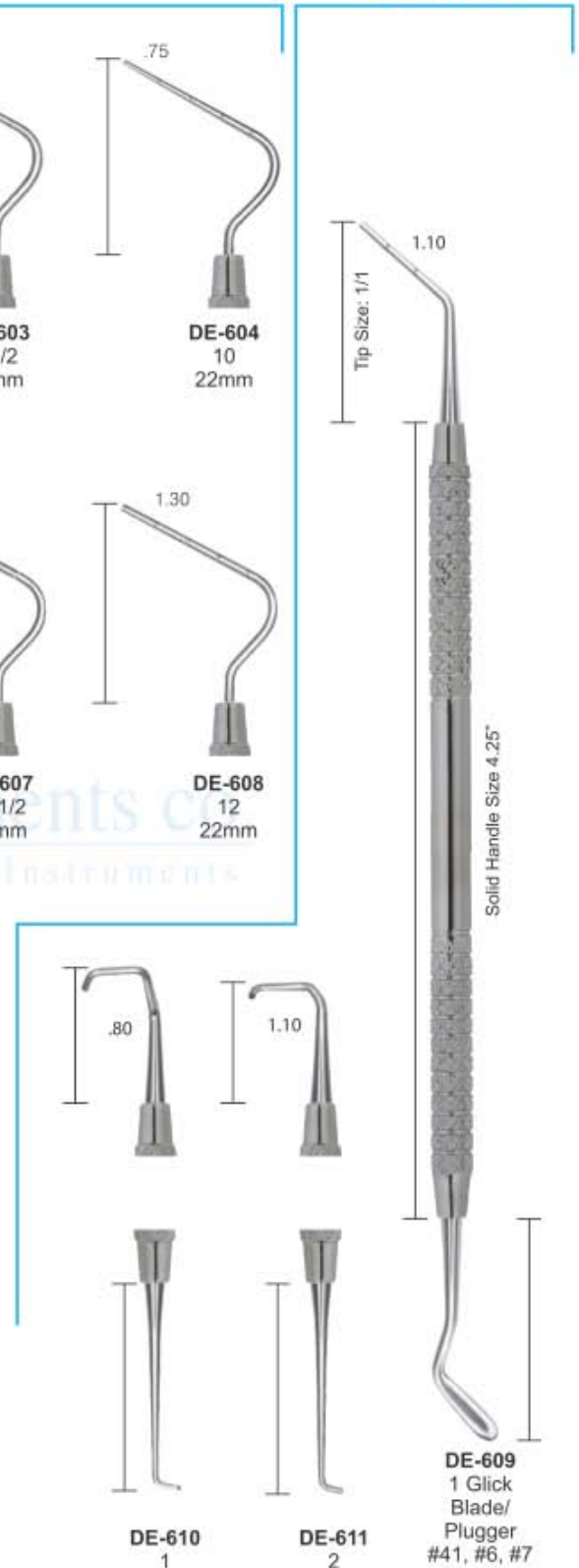



- Инструменты для реставрации
- Instruments pour plombage
- Füllungsinstrumente (mit Kontrawinkel)

- Инструменти для реставрації
- Instrumentos para obturaciones
- ملء الصكوك

COMPOSITE/PLASTIC FILLING INSTRUMENTS SOLID HANDLE 6MM, LENGTH 170MM

POSTERIOR

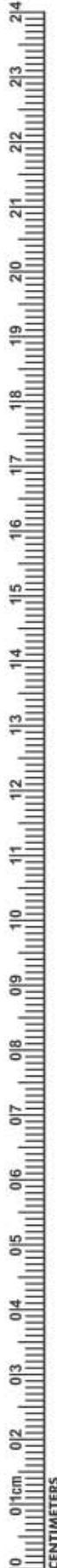

Tip Size: 1/1

Solid Handle Size 4.25"



DE-613
Interproximal
Off-angle



DE-614
2
HF



DE-615
49
Baldwin



DE-616
21
Burnisher
#41, #6



DE-617
21B
Burnisher
#41, #6



DE-618
PKT-3R
Rounded-
cone
#41, #6

UNIVERSAL FILLING INSTRUMENTS



DE-619
W3
#41, #6



DE-620
1



DE-621
BEQ1
Quélin
#41, #7



DE-622
1
HF



DE-623
3T
Tufts



DE-624
2
Woodson
#41, #6

DE-612
AB2
Boghosian

FILLING INSTRUMENTS



- Инструменты для реставрации
 - Instruments pour plombage
 - Füllungsinstrumente (mit Kontrawinkel)
- Инструменти для реставрації
 - Instrumentos para obturaciones
 - ملء الصكوك

COMPOSITE/PLASTIC FILLING INSTRUMENTS SOLID HANDLE 6MM, LENGTH 170MM

BLACK

PLUGGERS/CONDENSERS

Hollenback

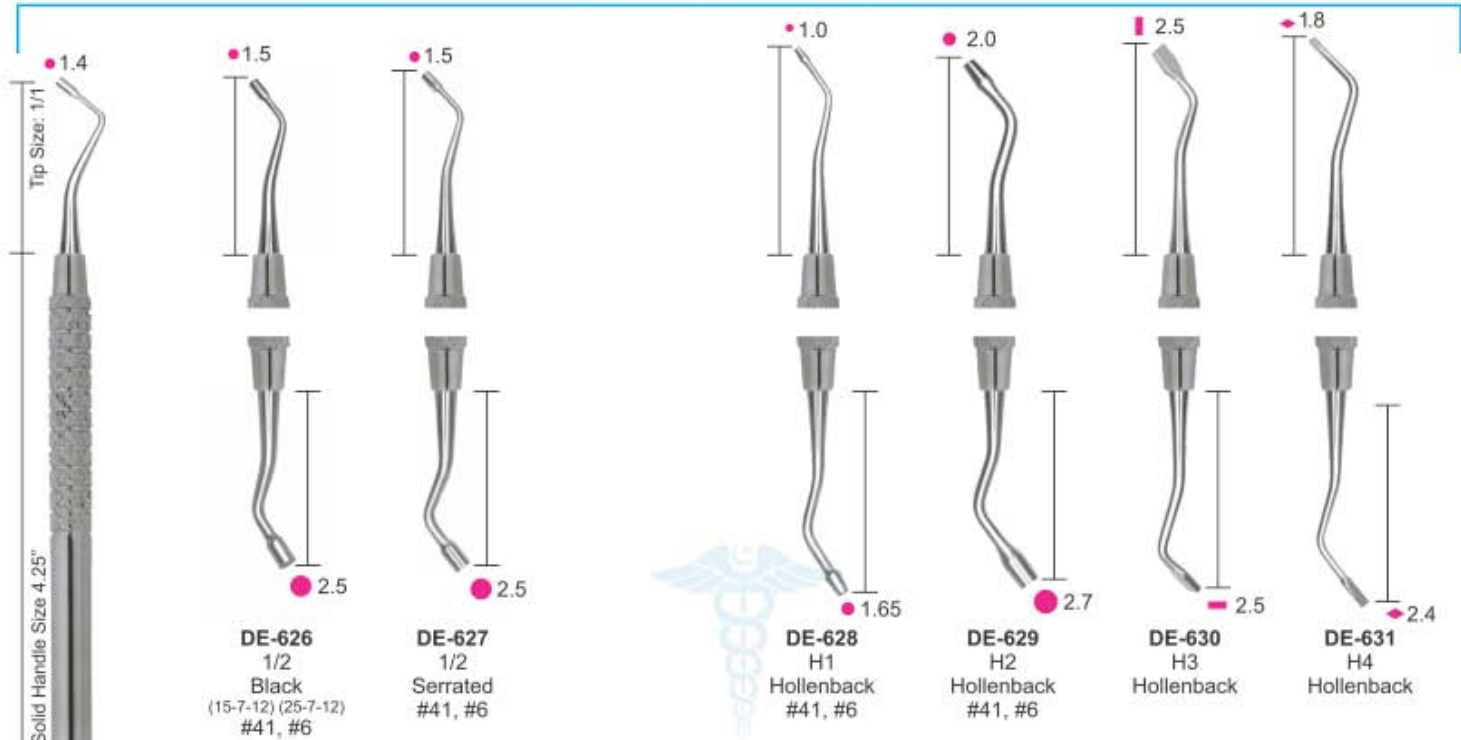

DE-626
1/2
Black
(15-7-12) (25-7-12)
#41, #6

DE-627
1/2
Serrated
#41, #6

DE-628
H1
Hollenback
#41, #6

DE-629
H2
Hollenback
#41, #6

DE-630
H3
Hollenback

DE-631
H4
Hollenback

MARQUETTE CONDENSER

MORTONSON

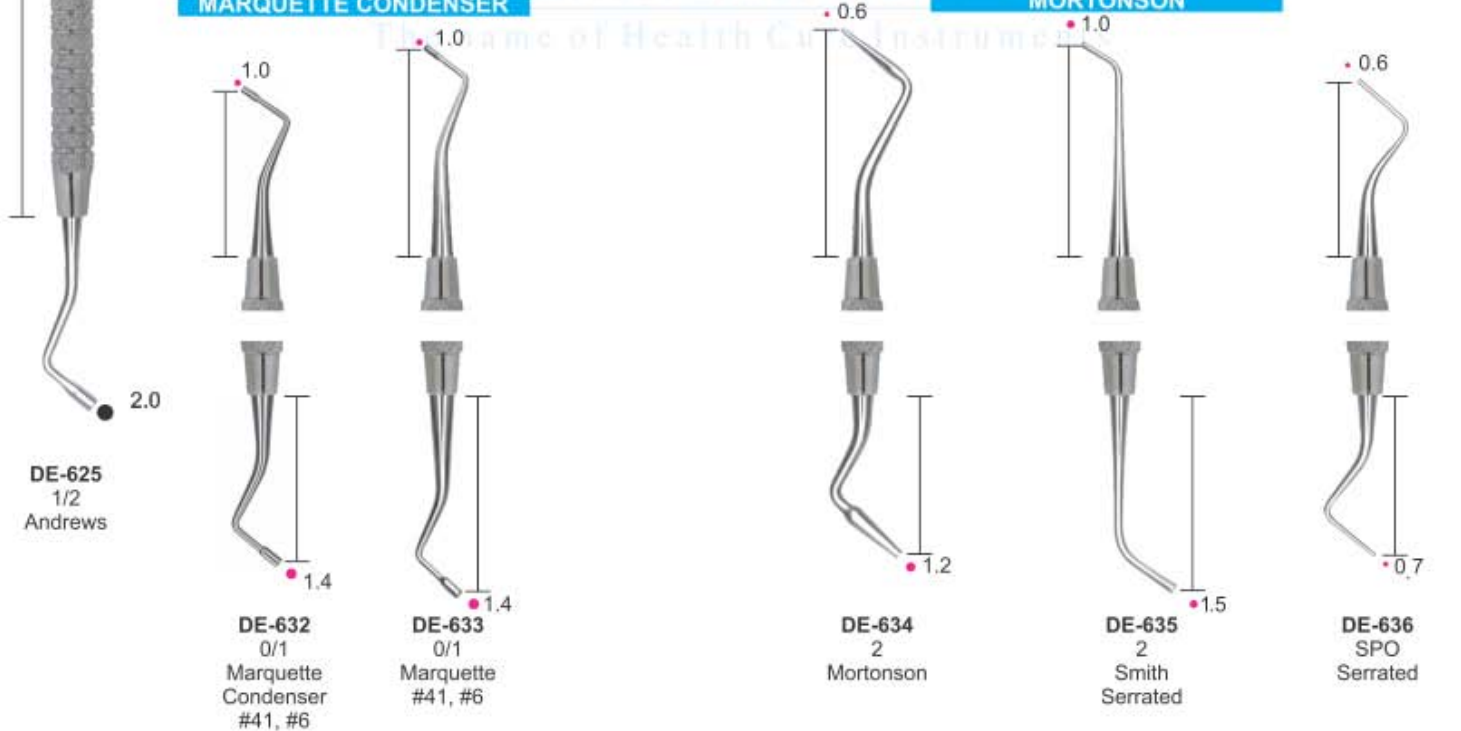

DE-625
1/2
Andrews

DE-632
0/1
Marquette
Condenser
#41, #6

DE-633
0/1
Marquette
#41, #6

DE-634
2
Mortonson

DE-635
2
Smith
Serrated

DE-636
SPO
Serrated



- Инструменты для реставрации
- Instruments pour plombage
- Füllungsinstrumente (mit Kontrawinkel)

- Инструменти для реставрації
- Instrumentos para obturaciones
- ملء الصكوك

PLUGGERS/CONDENSERS

RESTORATIVE INSTRUMENTS SOLID HANDLE 6MM, LENGTH 170MM

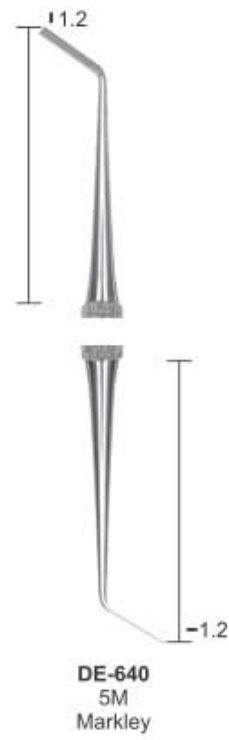
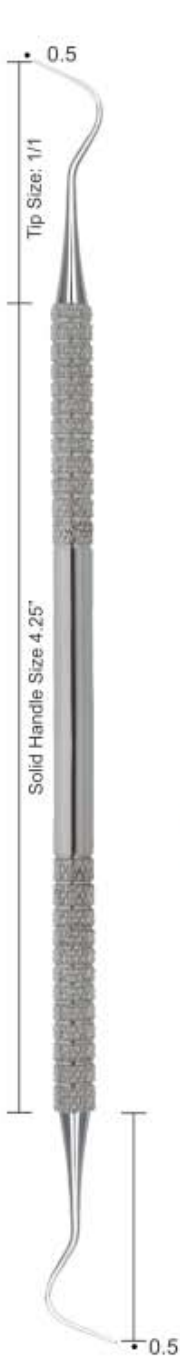

PLUGGERS/CONDENSERS



FILLING INSTRUMENTS



- Инструменты для реставрации
- Instruments pour plombage
- Füllungsinstrumente (mit Kontrawinkel)
- Инструменти для реставрації
- Instrumentos para obturaciones
- ملء الصكوك

RESTORATIVE INSTRUMENTS SOLID HANDLE 6MM, LENGTH 170MM Back Action Filling Instruments

Tanner Filling Instruments

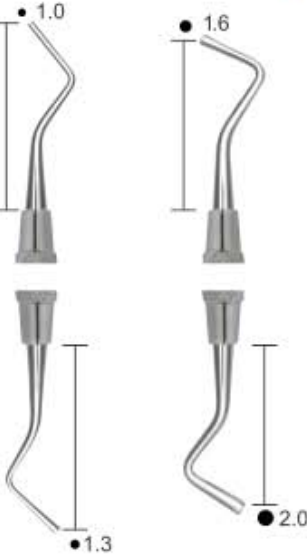
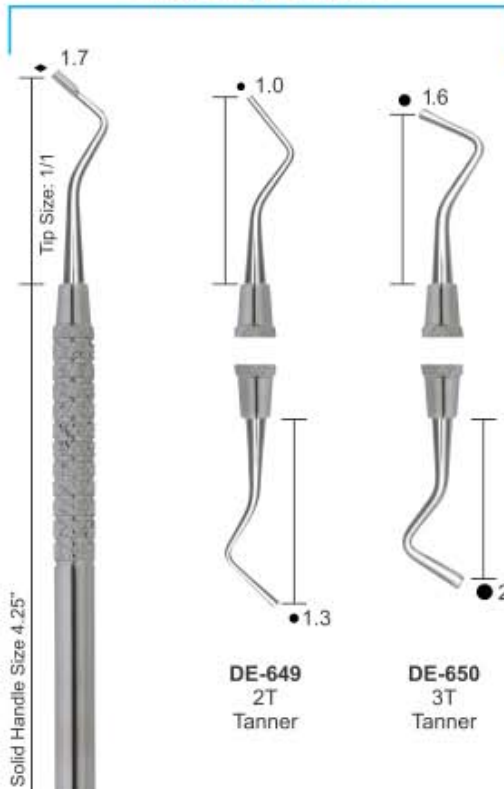

DE-649
2T
Tanner

DE-650
3T
Tanner



DE-651
9/10
Back Action



DE-652
11/12
Back Action



DE-653
153
English Pattern
Serrated



DE-654
153
English Pattern
Serrated

BURNISHERS

BALL



DE-655
18
#41, #6



DE-656
26/27S
#41, #6



DE-657
27/29
#41, #6, #7, #8



DE-658
2



DE-659
2
Double-End



DE-660
21
#41, #6



DE-661
21B
#41, #6, #8



DE-662
2
Ladmore

BEAVERTAIL

ACORN

LADMORE





- Инструменты для реставрации
- Instruments pour plombage
- Füllungsinstrumente (mit Kontrawinkel)

- Інструменти для реставрації
- Instrumentos para obturaciones
- ملء الصكوك

RESTORATIVE INSTRUMENTS SOLID HANDLE 6MM, LENGTH 170MM

BURNISHERS

PERIODONTAL FILES

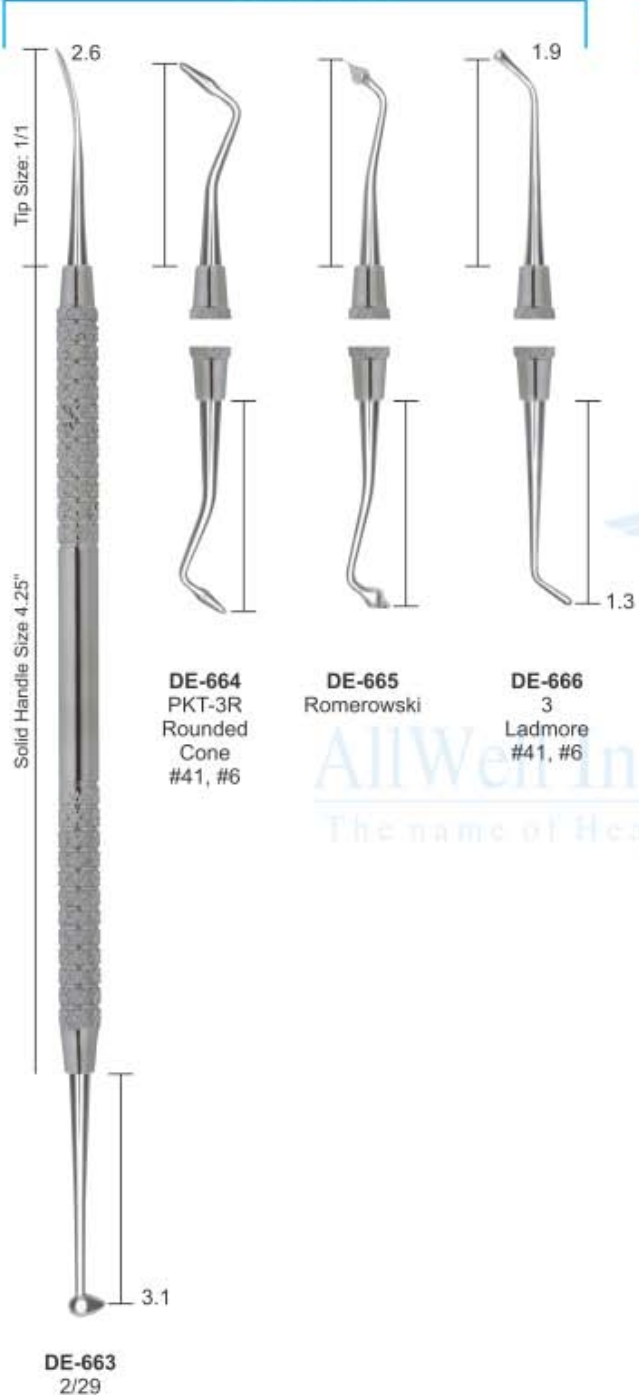

FILLING INSTRUMENTS



- Инструменты для реставрации
- Instruments pour plombage
- Füllungsinstrumente (mit Kontrawinkel)
- Инструменти для реставрації
- Instrumentos para obturaciones
- ملء التصكوك

COMPOSITE/PLASTIC FILLING INSTRUMENTS SOLID HANDLE 6MM, LENGTH 170MM

BURNISHER FILLING INSTRUMENTS

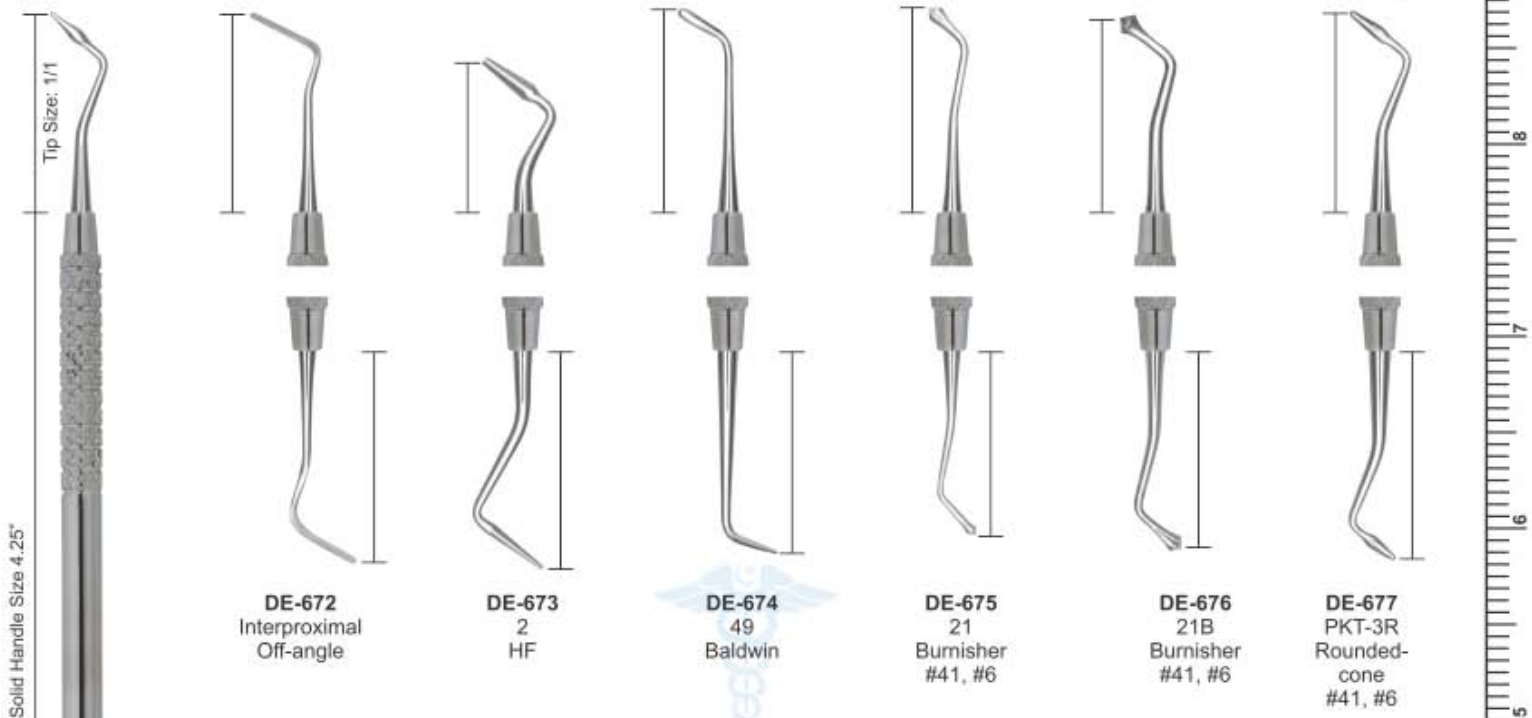

DE-672
Interproximal
Off-angle

DE-673
2
HF

DE-674
49
Baldwin

DE-675
21
Burnisher
#41, #6

DE-676
21B
Burnisher
#41, #6

DE-677
PKT-3R
Rounded-
cone
#41, #6

UNIVERSAL FILLING INSTRUMENTS

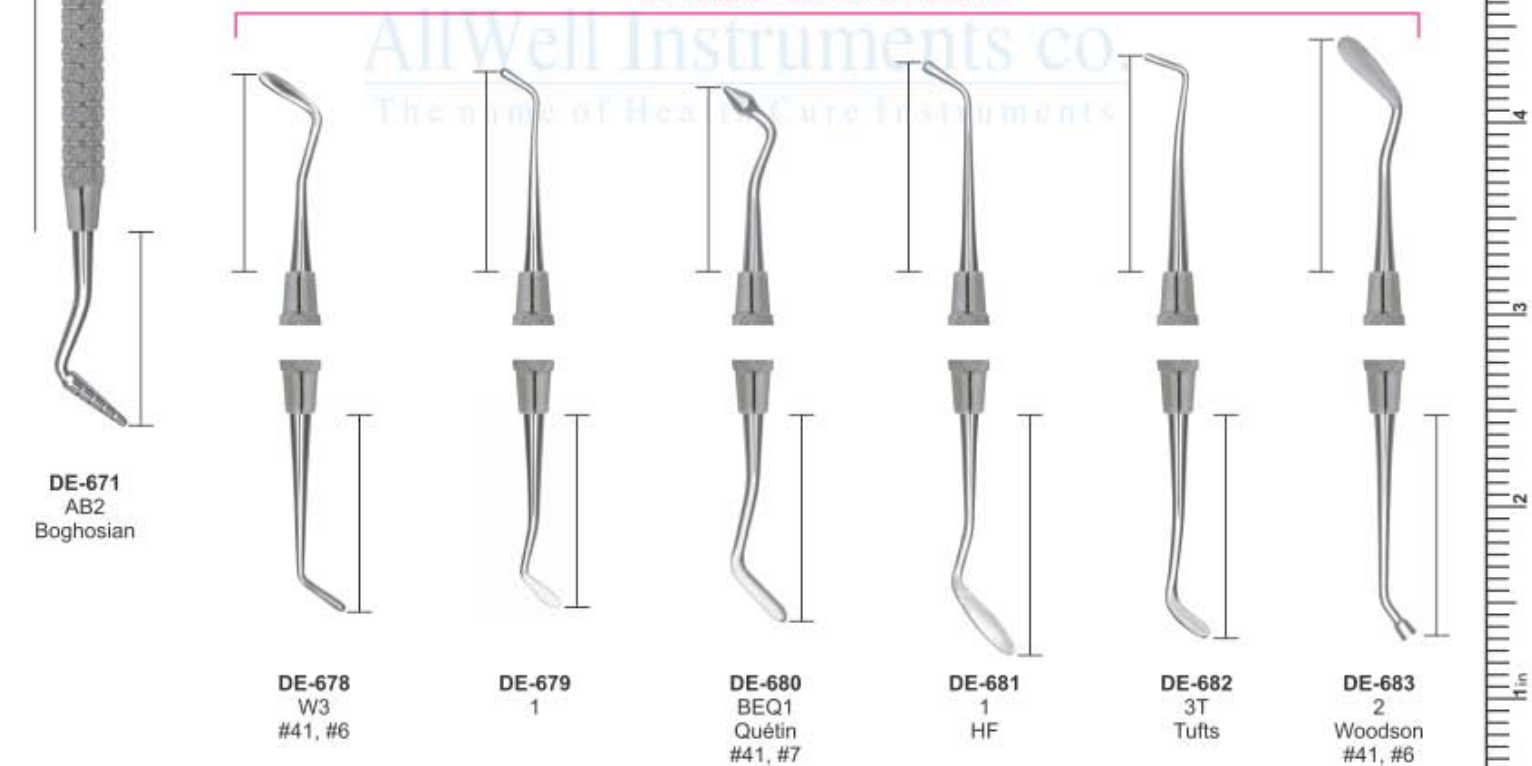

DE-671
AB2
Boghosian

DE-678
W3
#41, #6

DE-679
1

DE-680
BEQ1
Quétin
#41, #7

DE-681
1
HF

DE-682
3T
Tufts

DE-683
2
Woodson
#41, #6



- Инструменты для реставрации
- Instruments pour plombage
- Füllungsinstrumente (mit Kontrawinkel)

- Инструменти для реставрації
- Instrumentos para obturaciones
- ملء الصكوك

FILLING INSTRUMENTS
SOLID HANDLE 6MM, LENGTH 170MM



AMALGAM CARVERS



- Инструменты для реставрации
- Instruments pour amalgame
- Amalgampistolen
- Инструменти для реставрації
- Instrumentos para amalgama
- تطعيم الملعف

AMALGAM INSTRUMENTS SOLID HANDLE 6MM, LENGTH 170MM





- Инструменты для реставрации
- Instruments pour amalgame
- Amalgampistolen

- Инструменти для реставрації
- instrumentos para amalgama
- تطعيم المنعم

AMALGAM INSTRUMENTS
SOLID HANDLE 6MM, LENGTH 170MM

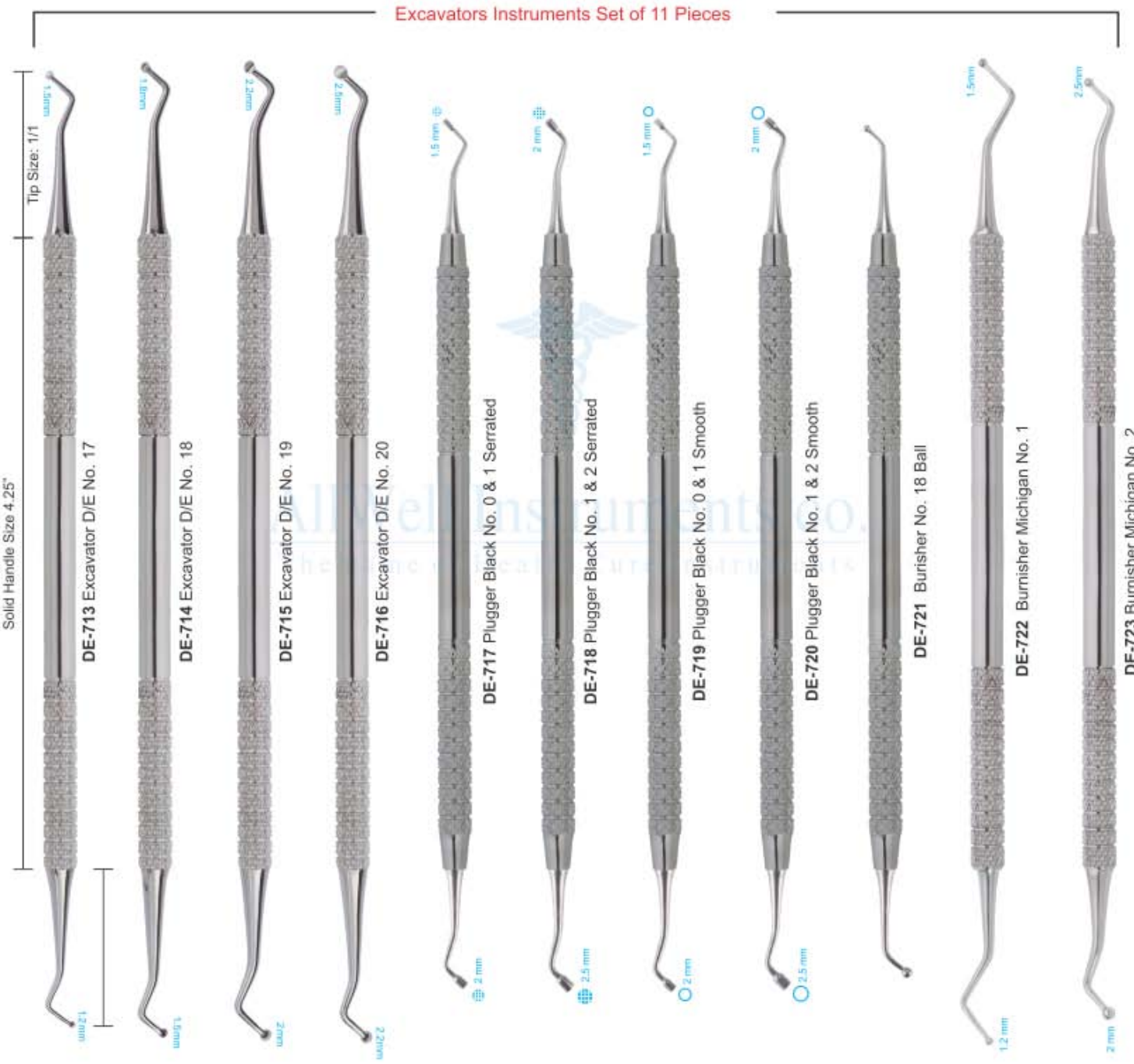

PERIODONTAL INSTRUMENTS



- Инструменты пародонтологические
- Instruments pour la parodontologie
- Instrumente für die Parodontologie
- Инструменти пародонтологічні
- Instrumentos para periodoncia
- المسكوك اللثة

SICKLE SCALERS INSTRUMENTS SOLID HANDLE 6MM, LENGTH 170MM

SICKLE SCALERS





- Инструменты пародонтологические
- Instruments pour la parodontologie
- Instrumente für die Parodontologie

- Інструменти пародонтологічні
- Instrumentos para periodoncia
- الصكوك اللثة

PERIODONTAL INSTRUMENTS SOLID HANDLE 6MM, LENGTH 170MM

JACQUETTE SCALERS

CRANE-KAPLAN

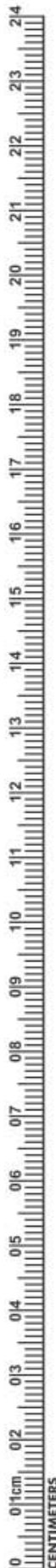

DE-731
30/33
Hygienist
Jacquette
#2, #4, #6,
#7, #8, #9

DE-732
31/32
Jacquette
#2, #4, #6,
#7, #8, #9

DE-733
34/35
Jacquette
#2, #4, #6,
#7, #8, #9

DE-734
H3/H4
Jacquette
#2, #4, #6,

DE-735
14/15
Posterior
Jacquette
#2, #4, #6,

DE-736
CK-6
#2, #4, #6,

PERIODONTAL INSTRUMENTS

AllWell Instruments co.
The name of Health Care Instruments



- Инструменты пародонтологические
- Instruments pour la parodontologie
- Instrumente für die Parodontologie
- Инструменти пародонтологічні
- Intrumentos para periodoncia
- الصكوك اللثة

PERIODONTAL INSTRUMENTS SOLID HANDLE 6MM, LENGTH 170MM SCALER/CURETTE SETS



DE-737
11/12
Scaler
#2, #6,
#7, #8

DE-738
11A/12A
Scaler
#2, #4, #6,

DE-739
11/12S
Modied
McCall
#4, #6

DE-740
13S/14S
Pointed
Curette
#2, #4, #6
#7, #8, #9

DE-741
MTC 13/14
Pointed
Curette
#4, #6

DE-742
17S/18S
Curette
#2, #4, #6
#7, #8, #9

DE-743
19/20
Curette
#2



- Кюрети
- Curetas
- Kuretten
- Кюрети
- Curette
- کرتس

SCALER/CURETTE SETS

GOLDMAN-FOX SET



- | | | | | | | | |
|---|---|---|---|---|---|--|--|
| DE-744
103/106
#4, #6 | DE-744A
104/105
Hoe/Chisel
#4, #6 | DE-745
107/108
#2, #4, #6
#7, #8 | DE-746
107/108S
Modied
#2, #4 | DE-747
1/2
(shown)
#2, #4, #6
#7, #8, #9 | DE-749
3/4†
(shown)
#2, #4, #6
#7, #8, #9 | DE-751
5/6†
(shown)
#2, #4, #6
#7, #8, #9 | DE-754
7/8†
(shown)
#2, #4, #6
#7, #8, #9 |
| DE-748
1/2
Rigid
#2, #4, #6
#7, #8, #9 | DE-750
3/4
Rigid
#2, #4, #6
#7, #8, #9 | DE-752
5/6
Rigid
#2, #4, #6
#7, #8, #9 | DE-753
5/6
Extra Rigid
#4, #6 #7,
#8 | DE-755
7/8
Rigid
#2, #4, #6
#7, #8, #9 | DE-756
7/8
Extra Rigid
#2, #4, #6
#7, #8, #9 | | |

SCALER/CURETTE SETS INSTRUMENTS
SOLID HANDLE 6MM, LENGTH 170MM

CURETTES



- Кюрети
- Curetas
- Küretten
- Кюрети
- Curette
- كرتس

GRACEY CURETTE INSTRUMENTS SOLID HANDLE 6MM, LENGTH 170MM
GRACEY CURETTES



DE-757
9/10†
(shown)
#2, #4, #6
#7, #8, #9

DE-759
11/12†
(shown)
#2, #4, #6
#7, #8, #9

DE-792
13/14†
(shown)
#2, #4, #6
#7, #8, #9

DE-765
15/16†
(shown)
#2, #4, #6
#7, #8, #9

DE-767
17/18
#2, #4, #6
#7, #8, #9

DE-758
9/10
Rigid
#2, #4, #6
#7, #8

DE-760 11/12 Rigid #2, #4, #6 #7, #8, #9	DE-761 11/12 Extra Rigid #4, #6 #7, #8
---	---

DE-793 13/14 Rigid #2, #4, #6 #7, #8, #9	DE-764 13/14 Extra Rigid #4, #6 #7, #8
---	---

DE-766
15/16
Rigid
#2, #4, #6
#7, #8, #9

DE-768
17/18
Rigid
#2, #4, #6
#7, #8, #9





- Кюрети
- Curetas
- Küretten
- Кюрети
- Curette
- كرتس



**CURETTE INSTRUMENTS
HOLLOW HANDLE 8.5MM, LENGTH 170MM**

**CURETTE INSTRUMENTS
SOLID HANDLE 6MM, LENGTH 170MM**

**CURETTE INSTRUMENTS
SOLID HANDLE 6MM, LENGTH 170MM**



DE-769
Hemingway
2mm, 2mm

DE-770
Hemingway
3mm, 3mm

DE-771
Hemingway
4mm, 4mm

DE-772
Hemingway
2mm, 2mm

DE-773
Hemingway
3mm, 3mm

DE-774
Hemingway
4mm, 4mm

DE-775
Hemingway
2mm, 2mm

DE-776
Hemingway
3mm, 3mm

DE-777
Hemingway
4mm, 4mm

EXCAVATORS

- Экскаваторы
- Excavateurs
- Excavatoren
- Excavatori
- Excavadores
- حفارات



EXCAVATORS INSTRUMENTS SOLID HANDLE 6MM, LENGTH 170MM SPOONS





- Экскаваторы
 - Excavateurs
 - Excavatoren
- Экскаватори
 - Excavadores
 - حفارات

OVAL SPOONS/DARBY-PERRY

EXCAVATORS INSTRUMENTS
SOLID HANDLE 6MM, LENGTH 170MM

EXCAVATORS

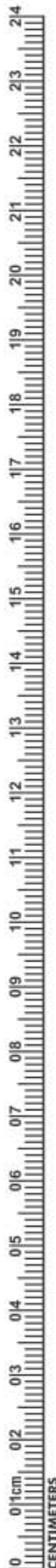

EXCAVATORS



- Экскаваторы
- Excavateurs
- Excavatoren
- Экскаватори
- Excavadores
- حفارات

**EXCAVATORS INSTRUMENTS
SOLID HANDLE 6MM, LENGTH 170MM**

BLADES

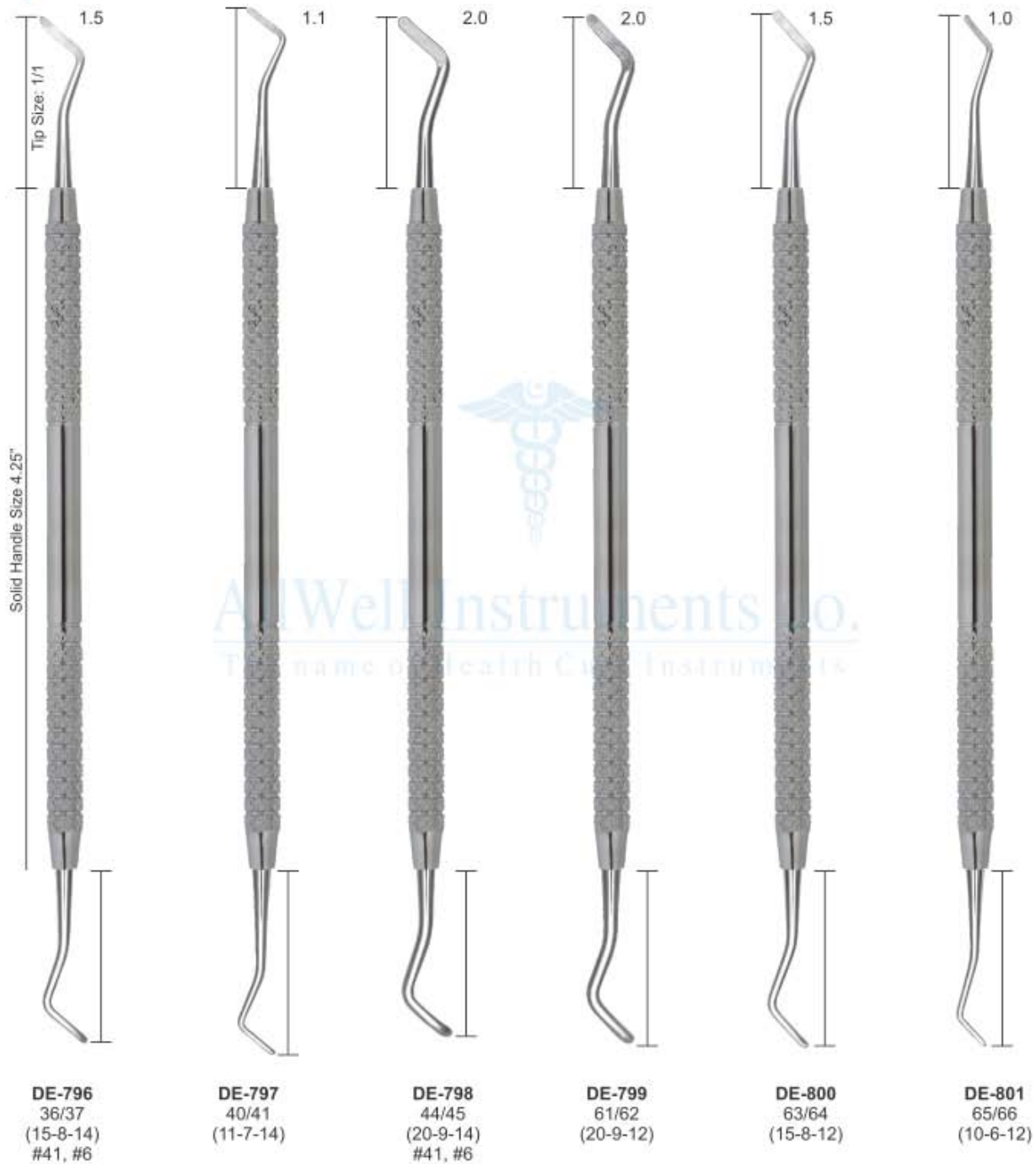



- Экскаваторы
- Excavateurs
- Excavatoren
- Экскаватори
- Excavadores
- حفارات

EXCAVATORS INSTRUMENTS SOLID HANDLE 6MM, LENGTH 170MM

ENGLISH PATTERNS



DE-802 Goldstein Interproximal Excavator	DE-803 243	DE-804 244	DE-805 245	DE-806 246	DE-807 125/126 #41, #6	DE-808 127/128 #41, #6	DE-809 129/130 #41, #6	DE-810 131/132 #41, #6	DE-811 153/154
--	----------------------	----------------------	----------------------	----------------------	-------------------------------------	-------------------------------------	-------------------------------------	-------------------------------------	--------------------------

FILLING INSTRUMENTS



- Инструменты для реставрации
 - Instruments pour plombage
 - Füllungsinstrumente (mit Kontrawinkel)
- Инструменти для реставрації
 - Instrumentos para obturaciones
 - ملء الصكوك

HATCHETS

RESTORATIVE INSTRUMENTS SOLID HANDLE 6MM, LENGTH 170MM

Tip Size: 1/1
Solid Handle Size 4.25"

Model	Specifications
DE-813	13/14 (20-9-14)
DE-814	15/16 (15-8-14)
DE-815	17/18 (10-6-14) #41, #6
DE-816	51/52 (15-8-12)
DE-817	53/54 (10-6-12) #41, #6
DE-812	8/9H (10-7-14) #41, #6
DE-818	8A #41, #6
DE-819	11 #41, #6
DE-820	179
DE-821	G
DE-822	1/2 Trico
DE-823	DPT6 Darby Perry Trimmer
DE-824	W1
DE-825	1 Woodson #41, #6

ANTERIOR

INCHES



- Инструменты для реставрации
- Instruments pour plombage
- Füllungsinstrumente (mit Kontrawinkel)

- Инструменти для реставрації
- Instrumentos para obturaciones
- ملء الصكوك

CARVERS

RESTORATIVE INSTRUMENTS SOLID HANDLE 6MM, LENGTH 170MM

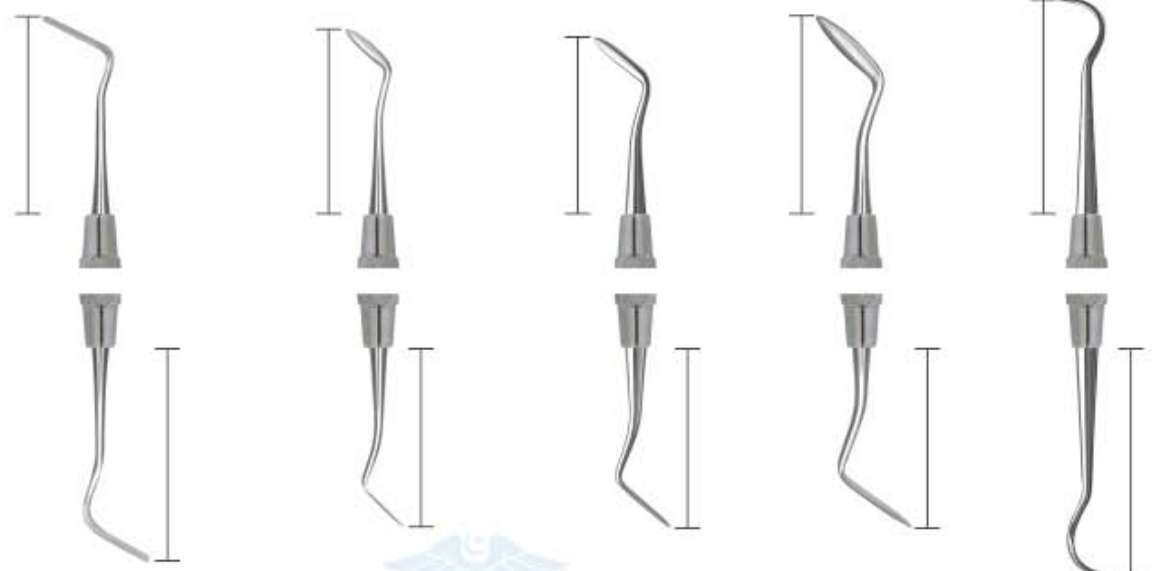

DE-827
Inter-proximal
Off-Angle

DE-828
1/2-3
Hollenback
#41, #6,
#7, #8

DE-829
3S
Hollenback
#41, #6, #7

DE-830
3
Hollenback

DE-831
8
Wiland
Minn.IPC1
#41, #6, #7

TANNER

WALL

WARD

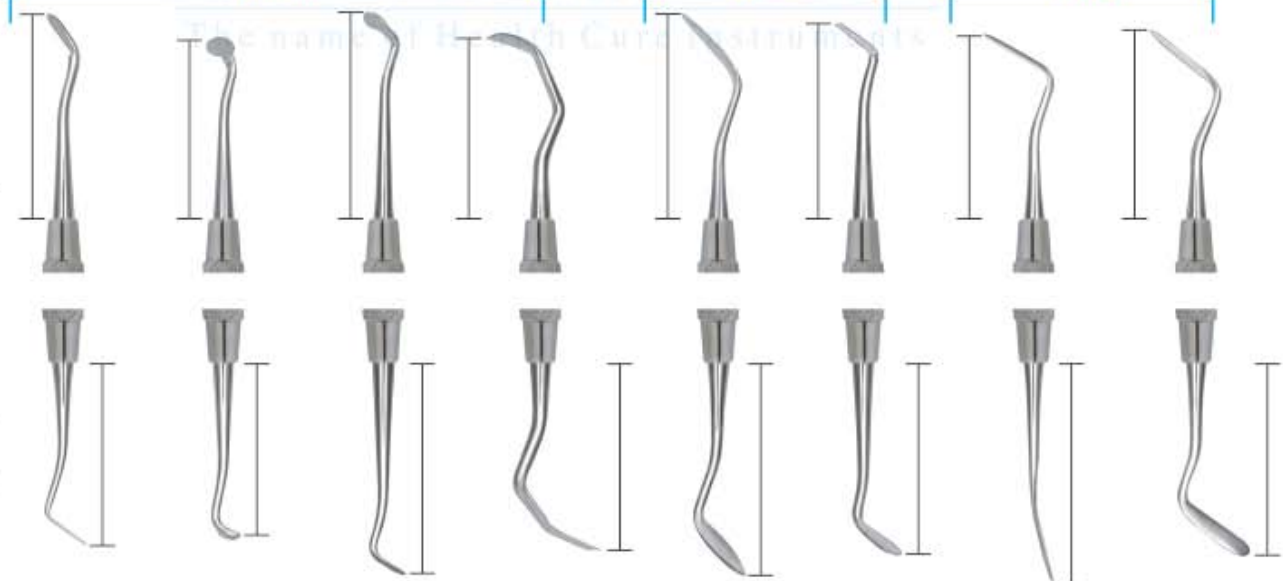

DE-826
Inter-proximal
#41, #6, #7

DE-832
3
Tanner

DE-833
4
Tanner

DE-834
5
Tanner

DE-835
6
Tanner

DE-836
1
Wall

DE-837
3
Wall

DE-838
1
Ward

DE-839
2
Ward

AMALGAM CARVERS



- Инструменты для реставрации
- Instruments pour amalgame
- Amalgampistolen
- Инструменти для реставрації
- Instrumentos para amalgama
- تقطيع الملمف

RESTORATIVE INSTRUMENTS

ANDREW SOLID HANDLE 6MM, LENGTH 170MM CLAPPISON/FRAHAM

HOLLENBACK

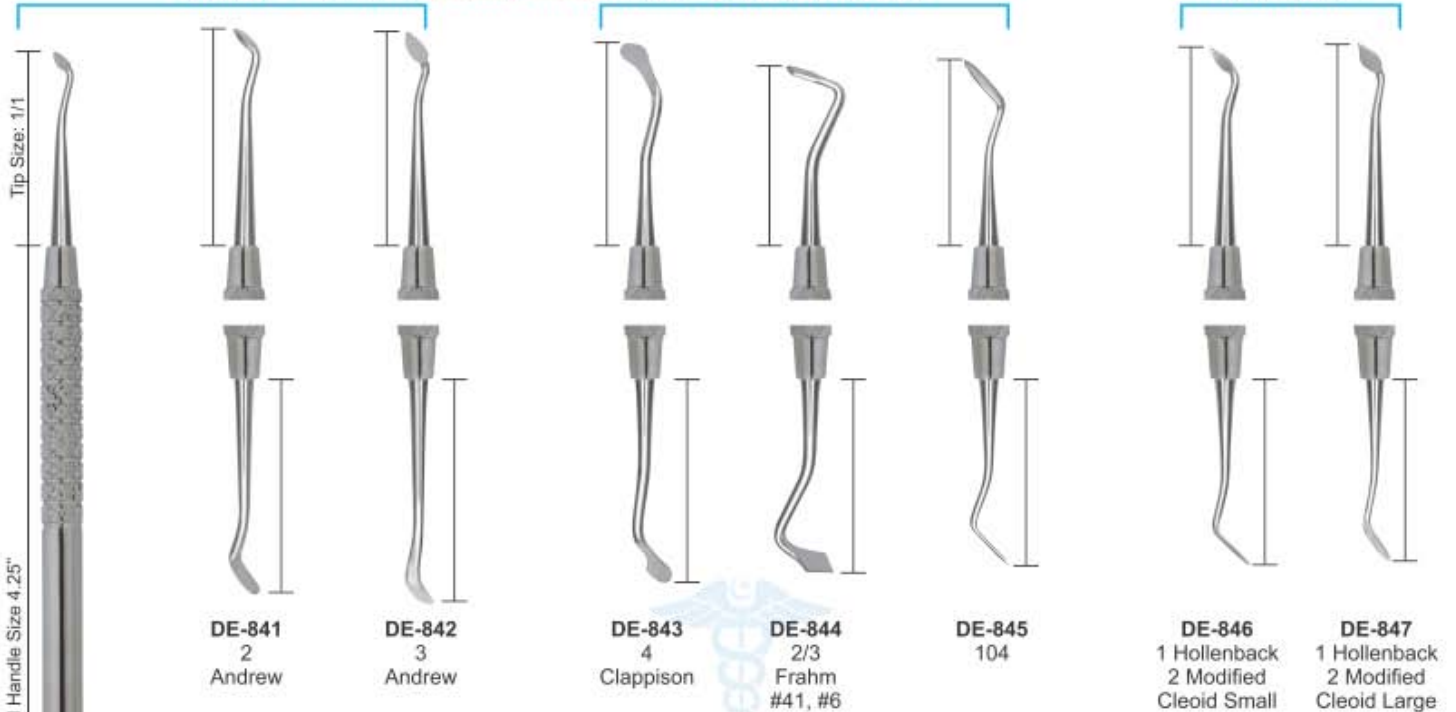

HOLLENBACK

THARP





- Инструменты для реставрации
- Instruments pour amalgame
- Amalgampistolen

- Инструменти для реставрації
- instrumentos para amalgama
- تقطیع المنجم

RESTORATIVE INSTRUMENTS SOLID HANDLE 6MM, LENGTH 170MM

CARVERS

AMALGAM FILES

HOES

Forming Line Angles on Anterior Preparations.



DE-856
Discoid-Cleoid Carver



DE-857
31/32 Rhein



DE-858
1/4 Wedelstaedt

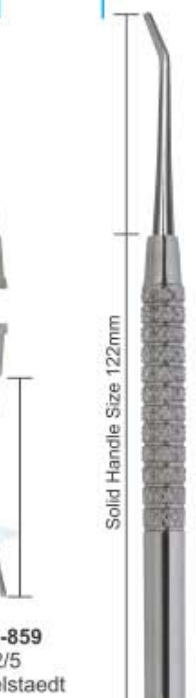

DE-859
2/5 Wedelstaedt

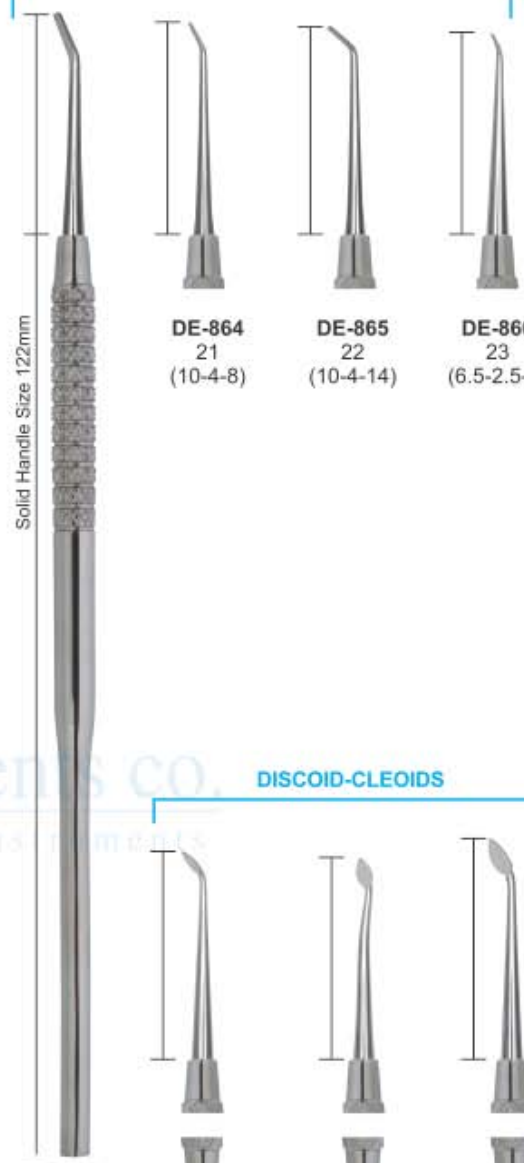

DE-864
21 (10-4-8)

DE-865
22 (10-4-14)

DE-866
23 (6.5-2.5-9)

DE-863
20 (14-6-8)

DISCOID-CLEOIDS

DISCOID-CLEOIDS



DE-860
1/2



DE-861
4/5 #41, #6, #7



DE-862
3/6 #41, #6, #7



DE-867
89/92 #41, #6, #7



DE-868
90B

DE-869
W-A-C-D

FILLING INSTRUMENTS



- Инструменты для реставрации
 - Instruments pour plombage
 - Füllungsinstrumente (mit Kontrawinkel)
- Инструменти для реставрації
 - Instrumentos para obturaciones
 - ملء التصكوك

RESTORATIVE INSTRUMENTS SOLID HANDLE 6MM, LENGTH 170MM

MARGIN TRIMMERS



DE-871
27
(13-80-8-14)
Mesial



DE-872
28
(10-95-7-14)
Distal
#41, #6



DE-873
29
(10-80-7-14)
Mesial
#41, #6



DE-874
77/78
(15-95-8-12)
Distal



DE-875
79/80
(15-80-8-12)
Mesial

DE-870
26
(13-95-8-14)
Distal

ANGLE FORMERS



DE-876
30/31
(12-80-5-8)



DE-877
32/33
(9-80-4-8)



DE-878
34/35
(7-80-2.5-9)





- Инструменты для реставрации
- Instruments a modeler
- Modellierinstrumente

- Інструменти для реставрації
- Instrumentos para modelar
- أدوات تلطيع

P.K. THOMS WAXING INSTRUMENTS SOLID HANDLE 6MM, LENGTH 170MM

P.K. THOMAS WAXING INSTRUMENTS

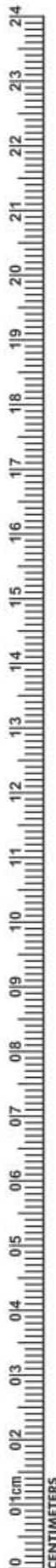

FILLING INSTRUMENTS



- Инструменты для реставрации
- Instruments pour plombage
- Füllungsinstrumente (mit Kontrawinkel)
- Инструменти для реставрації
- Instrumentos para obturaciones
- ملء الصكوك

CHISELS

HOES





- Шпатели для цемента
- Spatules à ciment
- Zementspatel

- Шпатели для цементу
- Espátulas para cemento
- ملاعق الاسمنت



DE-893
00



DE-894
0



DE-895
1



DE-896
2



DE-897
3



DE-898
4



DE-899
3
Weston



DE-900
1
medium cement



DE-901
1



DE-902
Le Cron



DE-903
Le Cron



DE-904
Le Cron



DE-905
MSY



DE-906
MSY



DE-907
Le Cron



DE-908
Hylin



DE-909
Hylin



DE-910
Hylin



DE-911
Zahle



DE-912
Zahle



DE-913
Zahle



DE-914
Gritman

AllWell Instruments co.
The name of Health Cure Instruments

WAX KNIVES



- Ножи для воска
- Couteaux a cire
- Wachsmesser
- Ножи для воску
- Cuchillos para cera
- السكاكين الشمع

ALGINATE, PLASTER SPATULAS, WAX KNIVES PLASTER FOR KNIVES & PLASTER SHEAR



DE-915
Wooden Handle
Fig. 5
21.5 cm



DE-916
Wooden Handle
Fig. 7
19.5 cm curved



DE-917
Wooden Handle
Fig. 8
20 cm curved



DE-918
Wooden Handle
Fig. 9
22.5 cm curved



DE-919
Hook Knives



DE-920
Fig. 1
Lessmann
12.5 cm



DE-921
Fig. 2
Lessmann
17 cm



DE-922
Fig. 1
with small spoon
12.5 cm



DE-923
Fig. 2
with large spoon
17 cm



DE-924
Bacolite Handle
Wax Knives,
Small



DE-925
Bacolite Handle
Wax Knives,
Large



DE-926
Wooden Handle
Wax Knives,
Small



DE-927
Wooden Handle
Wax Knives,
Large



DE-928
Plaster Knife



DE-929
Fig. 1
17 cm



DE-930
Fig. 3
16 cm



DE-931
Fig. 4
16 cm



DE-932
Special Inox
19.5 cm





- Артикуляторы
- Artocilar
- Artikulations

- Артикулятори
- Articuler
- ارتیکولاتورس



DE-933

Technical Datas:

Intercondylar distance	120 mm.
condylar inclination	fixed at 30°
Bennet angle	fixed at 7°
Incisal table inclination	10°
Distance between mounting plates	85 mm.
Weight	400 gr.
Opening (item 5000)	125°
Opening (item 5010)	180°



DE-934

Technical Datas:

Intercondylar distance	110 mm.
condylar inclination	fixed at 30°
Bennet angle	fixed at 7°
Incisal table inclination	flat
Distance between mounting plates	85 mm.
Weight	450 gr.
Opening	180°



DE-935

Stainless Steel Finishing
DE-936
Royal Blue



DE-937



DE-938



DE-939



DE-940



DE-941



DE-942



DE-943



DE-944



DE-945



DE-946
Nakawalni
Dental Laboratory
Instrument

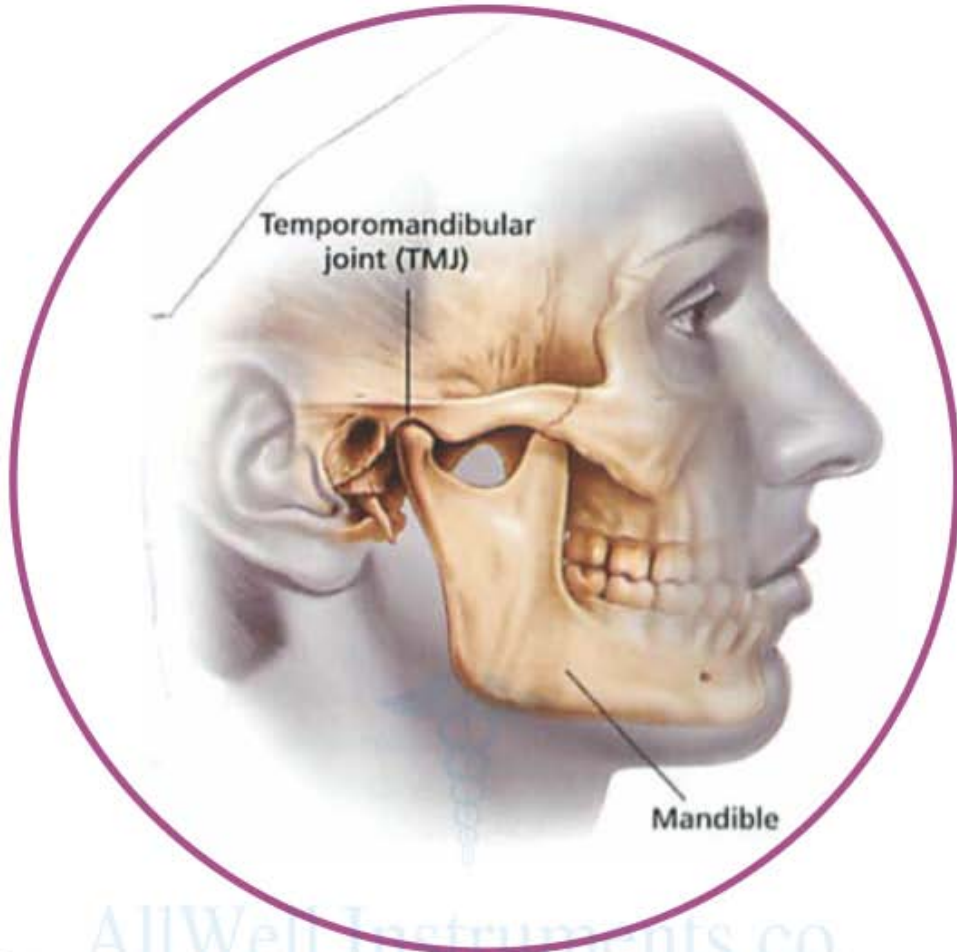

AllWell Instruments co.
The name of Health Cure Instrument





- Роторасширители
- Ecarteurs - Ouvre-bouches
- Vestibulumabhalter / Mundspanner
- Роторозширювачі
- Separadores - Abre-bocas
- الكاشطات-الكمامات الفم



DE-947
Mouth Gag Molt
11 cm for (Children)



DE-948
Mouth Gag Molt
14 cm for (Adults)



Cheek Retractor
DE-949 140 mm
DE-950 180 mm



Cheek Retractor
DE-951 140 mm



DE-952
Wangen Holder,
vestibule
15 cm, with or without
lip protection,



DE-953
Wangen Holder,
vestibule 15 cm, with
or without lip protection,



DE-954
Wangen Holder
Wangen holder with dual
function, 17 cm,



DE-955
140 mm

DE-956
150 mm

Cheek Retractor



RETRACTORS - MOUTH GAGS



- Роторасширители
- Ecarteurs - Ouvre-bouches
- Vestibulumabhalter / Mundspanner
- Роторозширювачі
- Separadores - Abre-bocas
- الكاشطات-الكمامات الفم



DE-957
Fig. 1
Weitlander
10.5cm
13.5cm



DE-958
Fig. 2
Weitlander
10.5cm
13.5cm



DE-959
Stainless Steel
Double
Ended Cheek
Retractors



DE-960
Stainless Steel
Single
Ended Cheek
Retractors



Weitlander
DE-961 11cm
DE-962 13cm
DE-963 15cm



DE-967
Denhard
12 cm



DE-968
Roser-König
16 cm



DE-969
Roser-König
19 cm



Jennings
DE-964 11cm
DE-965 13cm
DE-966 15cm





Wound, Bendable
Retractor, individually or as saving kit!

- Ранорасширители
- Ecarteurs
- Wundhaken

- Ранорозширювачі
- Separadores
- الكاشحات

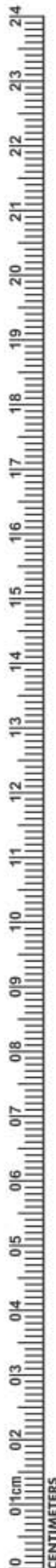

DE-970
Cheek Retractor
Long



DE-971
Cheek Retractor
Long



DE-972
Cheek Retractor
Long



**Retractor with
Ergo Grip
DE-973** 24 cm,
ergonomic handle,



DE-974
Cheek Retractors,
Retractor Ivory
Width adjustable
& fixable, 20 cm,



**Cheek Retractors,
tongue depressors
DE-975** 19 cm



**Cheek Retractors,
Minnesota
DE-976** 16 cm



**Cheek Retractors,
DE-977** 20 cm
easy to bend
by hand,



**Cheek Retractors,
retractor and tongue
pushers BISHOP with
comfortable margin,
DE-978** 16 cm,



**Retractors Cheek
retractor combination
Combination,
DE-979** 25 cm,

RETRACTORS



- Ранорасширители
 - Ecarteurs
 - Wundhaken
- Ранорозширювачі
 - Separadores
 - الكاشحات



DE-982
Retractors, Unique
Length 175 mm,
angled 45°



DE-983
Retractors, Unique
Length 175 mm,
angled 90°



DE-984
Retractors
16cm



DE-985
Retractors
19cm



DE-986
Retractors, Mini-Langenbeck
16 cm, hooks 22 mm,



DE-987
Retractors, Cheek
retractors combination
21 cm, 2



DE-988
Mini Retractor
about 8 cm,



DE-989
Retractors
17 cm, hooks 22 mm





- Ранорасширители
 - Ecarteurs
 - Wundhaken
- Ранорозширювачі
 - Separadores
 - الكاشحات



DE-990
Retractors, surgical-flat
surgically-flat, 21 cm, hook
30x16 mm,



DE-991
Retractors, surgical-flat
surgically-flat, 21 cm, hook
42x11 mm



DE-992
Retractors, surgical-flat
surgically-flat, 21 cm, hook
63x12 mm,



Retractors, surgical-flat
surgically-flat, 21 cm, hook
DE-993 30x16 mm,
DE-994 42x11 mm,
DE-995 63x12 mm,



Retractors, Langenbeck
21 cm, hook
DE-996 30x11 mm
DE-997 30x16 mm,



DE-998
Retractors
21 cm,



DE-999
Farabeuf
(120 X 12mm
Set of 2 pices)



DE-1000
Retractor Seldin



DE-1001
FELDMAN
RETRACTOR
5-1/2", 14cm



GUM SCISSORS



- Ножницы десневые
- Ciseaux a gencives
- Zahnfleischscheren
- Ножиці для ясен
- Tijeras para encias
- مقص صمغ



DE-1002
Iris
115mm
Straight



DE-1003
Iris
115mm
Curved



DE-1004
Goldman-Fox
130mm
Saw edge, straight



DE-1005
Goldman-Fox
130mm
Saw edge, Curved



DE-1006
La Grange
115mm
Saw edge, double Curved



Mayo
DE-1007 140mm
DE-1008 170mm
DE-1009 230mm
Straight



Mayo
DE-1010 140mm
DE-1011 170mm
DE-1012 230mm
Curved



Metzenbaum
DE-1013 145mm
DE-1014 180mm
DE-1015 200mm
Straight



Metzenbaum
DE-1016 145mm
DE-1017 180mm
DE-1018 200mm
Curved



DE-1019
Kelly
160mm
Straight



DE-1020
Kelly
160mm
Curved



DE-1021
Iris
115mm
Straight



DE-1022
Iris
115mm
Curved



DE-1023
La Grange
115mm
Double Curved



DE-1024
Goldman-Fox
130mm, Straight



DE-1025
Goldman-Fox
130mm, Curved



DE-1026
Kelly
160mm, Curved



DE-1027
Iris
115mm, Straight



DE-1028
Iris
115mm, Curved



DE-1029
Micro Iris
90mm, Curved





- Ножницы десневые
- Ciseaux a gencives
- Zahnfleischscheren

- Ножиці для ясен
- Tijeras para encias
- مقص صمغ



DE-1030
Iris
115mm
Angled



DE-1031
Iris
115mm
Curved



DE-1032
Goldman-Fox
130mm
Saw edge,
straight



DE-1033
Goldman-Fox
130mm
Saw edge,
curved



DE-1034
Goldman-Fox
130mm
Saw edge,
double curved



DE-1035
La Grange
115mm
Saw edge,
double curved



DE-1036
Neumann
120mm
Saw edge,
double curved



DE-1037
Kilner (Ragnell)
120mm
Straight



DE-1038
Kilner (Ragnell)
120mm
Curved



DE-1039
Joseph
140mm
Straight



DE-1040
Joseph
140mm
Curved



DE-1041
Kelly
160mm
Straight



DE-1042
Kelly
160mm
Curved



DE-1043
Locklin
160mm
Saw edge,
angular



DE-1044
Locklin
120mm
160mm
Saw edge,
angular



DE-1045
Dean
170mm
Saw edge,
angular



DE-1046
Spencer
90mm



DE-1047
Spencer
130mm



DE-1048
Spencer
115mm



DE-1049
Noyes
110mm, Straight



DE-1050
Noyes
110mm
Curved



DE-1051
Noyes
110mm
Angular



DE-1052
Castroviejo
150mm
Curved

NEEDLE HOLDERS



- Иглодержатели
 - Porte-aiguilles
 - Nadelhalter
- Голкотримачі
 - Porta-agujas
 - أصحاب ابرة



DE-1053
130mm
Straight



DE-1054 Mayo 130mm
DE-1055 Mayo 160mm
DE-1056 Mayo 180mm
Straight Curved



DE-1057 Mayo 140mm
DE-1058 Mayo 200mm
Straight Curved



DE-1059 Metzenbaum 145mm
DE-1060 Metzenbaum 200mm
Straight Curved



DE-1061
Beebee 110mm
Saw edge, straight



DE-1062
Beebee 110mm
Saw edge, curved



DE-1063
Beebee 110mm
Saw edge, straight



DE-1064
Beebee 110mm
Saw edge, curved



DE-1065
Universal 120mm
Saw edge



DE-1066
Universal 120mm



Crile
DE-1067 130mm
DE-1068 150mm
DE-1069 180mm



DE-1070
Halsey 130mm



DE-1071
Baumgartner 130mm



DE-1072
Derf 120mm



DE-1073
Delicate 150mm



Mayo-Hegar
DE-1074 130mm
DE-1075 160mm
DE-1076 180mm
DE-1077 200mm



DE-1078
Crile-Wood 150mm
straight



DE-1079
Crile-Wood 150mm
curved





- Иглодержатели
- Porte-aiguilles
- Nadelhalter

- Голкотримачи
- Porta-agujas
- اصحاب ابرة



Castroviejo
DE-1080 130mm
DE-1081 150mm
DE-1082 180mm



DE-1083
Halsey
130mm



DE-1084
Baumgartner
130mm



DE-1085
Derf
120mm



DE-1086
Delicate
150mm



DE-1087
Adson
170mm



Mayo-Hegar
DE-1088 130mm
DE-1089 160mm
DE-1090 180mm
DE-1091 200mm



DE-1092
Crile-Wood
150mm



Castroviejo
DE-1093 str 140mm cvd
DE-1094 str 180mm cvd



Olsen-Hegar Needle
Holder With Scissors
DE-1095 140mm



Gillies Needle
Holder With Scissors
DE-1096 160mm



Mathieu
DE-1097 140mm
DE-1098 170mm



Castroviejo
DE-1099 str 140mm cvd
DE-1100 str 180mm cvd



Olsen-Hegar Needle
Holder With Scissors
DE-1101 140mm



Gillies Needle
Holder With Scissors
DE-1102 160mm



Hartmann (Baby
Mosquito)
DE-1103 90mm straight



Halstead Mosquito
DE-1105 125mm
Straight

DE-1106
Curved

DE-1104
125mm
Curved

HAEMOSTATIC FORCEPS & TOWEL CLAMPS

AllWell Instruments co.

The name of Health Care Instruments



- Зажимы артериальные, зажимы для салфеток
- Pincas hemostaticas, Pincas a compresas
- Arterienklemmen, Tuschklemmen
- Затискачі артеріальні, затискачі для серветок
- Pinzas hemostaticas, Pincas para compresas
- الملقط هيموستاتيک المشابك متشعبة

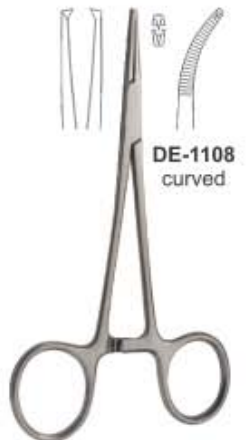

Halstead Mosquito 1x2
DE-1107 125mm
straight



Kelly
DE-1109 140mm
straight



Rochester-Pean
DE-1111 140mm
DE-1112 160mm
DE-1113 180mm
DE-1114 200mm
straight



Rochester-Kocher 1x2
DE-1119 140mm
DE-1120 160mm
DE-1121 180mm
DE-1122 200mm
straight



DE-1127
Kelly-Rankin
160mm
straight



Lorna
DE-1129 100mm
DE-1130 130mm



DE-1131
Allis-Baby 3:4
150mm



DE-1132
Allis 4:5
200mm



DE-1133
Allis 6:7
200mm



Backhaus
DE-1134 140mm
Not-perforating and
not-damaging



DE-1135
Backhaus
130mm



DE-1136
Backhaus
85mm



DE-1137
Jones
90mm



Gross Maier
Dressing Forceps
DE-1138 200mm straight



Foerster
Dressing Forceps
DE-1140 200mm



Young
Tongue Forceps
DE-1141 170mm



Collins
Tongue Forceps
DE-1142 170mm





- Инструменты для системы коффердам
- Pincas porte-crampons a digue
- Kofferdam Klammerzangen
- Инструменты для системи коффердам
- Pinzas de engrapar para dique de caucho
- المد المطاط المنقاط المشابه



DE-1143

On request the Content of the rubber dam kit can be changed with other instruments.

Content:

- | | |
|------------------------------|------------------------------|
| 01 Anisworth | 08 Rubber Dam Clamp Fig. 212 |
| 02 Brewer | 09 Rubber Dam Clamp Fig. 211 |
| 03 Clamps Stand | 10 Rubber Dam Clamp Fig. 8 |
| 04 Denture Plate | 11 Rubber Dam Clamp Fig. 8A |
| 05 Rubber Dam Frame | 12 Rubber Dam Clamp Fig. 14 |
| 06 Rubber Dam Box Lower Case | 13 Rubber Dam Clamp Fig. 14A |
| 07 Rubber Dam Box Upper Case | 14 Rubber Dam Clamp Fig. 0 |
| | 15 Rubber Dam Clamp Fig. 00 |
| | 16 Rubber Dam Clamp Fig. 2 |
| | 17 Rubber Dam Clamp Fig. 2A |
| | 18 Rubber Dam Clamp Fig. 7 |



DE-1144
Anisworth



DE-1145
Brewer



DE-1146
Ivory light weight



DE-1147
Palmer



DE-1148
Separating
Elastic
Plier



RUBBER DAM CLAMPS



- Кламмера для коффердама
- Crampons pour digue
- Kofferdam Klammern
- Кламмера для коффердама
- Grapas para dique de caucho
- المشابك السد المطاط



DE-1149
Fig. 15



DE-1150
Fig. 18



DE-1151
Fig. 24



DE-1152
Fig. 25



DE-1153
Fig. 26



DE-1154
Fig. 28



DE-1155
Fig. 30



DE-1156
Fig. 31



DE-1157
Fig. 51



DE-1158
Fig. 138



DE-1159
Fig. 139



DE-1160
Fig. 200



DE-1161
Fig. 201



DE-1162
Fig. 202



DE-1163
Fig. 203



DE-1164
Fig. 204



DE-1165
Fig. 205



DE-1166
Fig. 3



DE-1167
Fig. W3



DE-1168
Fig. 4



DE-1169
Fig. 56A



DE-1170
Fig. 7



DE-1171
Fig. 7A



DE-1172
Fig. 8



DE-1173
Fig. 8A



DE-1174
Fig. W8A



DE-1175
Fig. 10



DE-1176
Fig. 11



DE-1177
Fig. 12A



DE-1178
Fig. 13A



DE-1179
Fig. 14



DE-1180
Fig. 14A



DE-1181
Fig. 14AN



DE-1182
Fig. 22



DE-1183
Fig. 27



DE-1184
Fig. 207



DE-1185
Fig. 29



DE-1186
Fig. 206



DE-1187
Fig. 208



DE-1188
Fig. 209



DE-1189
Fig. 1



DE-1190
Fig. 1A



DE-1191
Fig. 2



DE-1192
Fig. 2A



DE-1193
Fig. W2A



DE-1194
Fig. 0



DE-1195
Fig. 00



DE-1196
Fig. 210



DE-1197
Fig. 211



DE-1198
Fig. 212



DE-1199
Fig. 6



DE-1199
Fig. 6



DE-1200
Fig. 9



DE-1200
Fig. 9



DE-1201
Fig. N06



DE-1202
Fig. U67



DE-1203
Fig. 214



DE-1204
Fig. P1



DE-1205
Fig. P2



DE-1206
Fig. G-1



DE-1206
Fig. G-1



DE-1207
Fig. G-2



DE-1207
Fig. G-2





- Инструменты для удаления коронок
- Arrache-couronnes
- Teleskopkronenzangen

- Инструменты для видалення коронок
- Arranca-corona
- مزبلات التاج



DE-1210
Crown Spreaders



DE-1211
Mershon
14 cm
Band Pusher



DE-1212
Fig. 0



DE-1213
Manual Crown Remover



DE-1214
Complete with 3 tips
and tightening keys

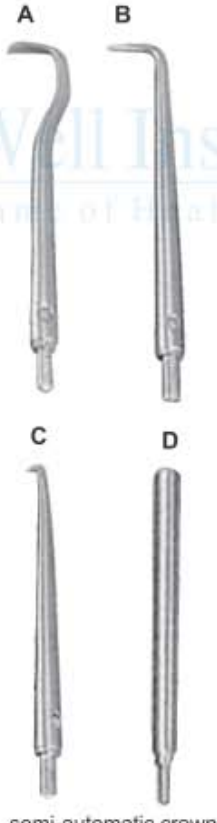

semi-automatic crown
& bridge remover



DE-1215



DE-1216
Manual Crown Remover



MATRIX RETAINERS



- Матрицедержатели
- Porte Matrices
- Matrizenspanner

- Матрицеутримувачи
- Porta Matrices
- مصلولة الخدم



DE-1217
Fig. 5
Ivory 8
5 cm



DE-1218
Fig. 6
Ivory 8
6 cm



DE-1219
Fig. 7
Ivory 8
7 cm



DE-1220
Fig. 1
Tofflemire-Universal



DE-1221
Fig. 2
Tofflemire-Junior



DE-1222
Fig. 3
Tofflemire-Senior



DE-1223
Narrow



DE-1224
Wide

Siqueland Retainers

Amalgam Well



DE-1225
Stainless Steel
Amalgam Well



DE-1226
Ivory 12



DE-1227
Ivory 1



DE-1228
Ivory



DE-1229
Elliot





- Инструменты для амальгамы
- Instruments pour amalgame
- Amalgamis/instrumente

- Инструменты для амальгами
- Instrumentos para amalgama
- الصكوك المنغم

- Ручки для скальпелей
- Manches de bistouris
- Skalpellgriffe

- Ручки для скальпелів
- Mangos de bisturi
- مشرط مقبض



Ø 2mm

DE-1230 Fig. 10 165mm English pattern



Ø 2mm

DE-1231 Fig. 1 185mm German pattern



Ø 2mm

DE-1232 Fig. 1 150mm Swiss pattern



Ø 2mm

DE-1233 Fig. 1 150mm



Ø 2mm

DE-1234 Fig. 2 150mm, 45°



Ø 2mm

DE-1235 Fig. 3 140mm, 90°



DE-1236 Fig.3 5" (12.7cm)



DE-1237 Fig.3G 5" (12.7cm)



DE-1238 Fig.4 5 1/2" (13.7cm)



DE-1239 6 Way Adjustable Angled Scalpel Handle



Locks At 90°, 60°, 30°, Straight, 120°, 150°, 180°, Angles



- Инструменты для амальгамы
- Instruments pour amalgame
- Amalgamisinstrumente
- Инструменти для амальгами
- Instrumentos para amalgama
- الصكوك الملغم

AMALGAM CARRIERS

DE-1240
Distal
Improves visibility and access to posterior regions.

DE-1241
Single-End

DE-1242
Double-End

TIP SIZES FOR DOUBLE-END

Tip Size 1	Tip Size 2	Tip Size 3
1.5 mm	2.8 mm	3.2 mm
2.0 mm	2.0 mm	2.0 mm
DE-1243 Mini/ Regular	DE-1244 Large/ Regular	DE-1245 Jumbo/ Regular

TIP SIZES FOR DISTAL OR SINGLE-END

Tip Size 1	Tip Size 2	Tip Size 3
1.5 mm	2.0 mm	2.8 mm
DE-1246 Mini/ Single-End	DE-1247 Regular Single-End	DE-1248 Large Single-End

DE-1249 Mini Distal	DE-1250 Regular Distal	DE-1251 Amalgam Well





ROOT PLANNING FILES



DE-1252
Kramer-Nevis
Bone Chisel



DE-1253
Kramer-Nevis
Bone Chisel



DE-1254
Molt 18.5cm
Auto Clavable
Plastic Tips.



DE-1255
Mead 18.5cm
Non Auto Clavable
Plastic Tips.



DE-1256
Miller



DE-1257
Miller

BONE FILES



DE-1258
Miller 21



DE-1259
Miller 1X
cross cut



DE-1260
Miller 2X
cross cut



DE-1261
Miller 52



DE-1262
Wahl 1



PERIODONTAL INSTRUMENTS



- Инструменты пародонтологические
- Instruments pour la parodontologie
- Instrumente für die Parodontologie
- Инструменти пародонтологічні
- Instrumentos para periodoncia
- الصكوك اللثة

PERIOSTEEL ELEVATORS

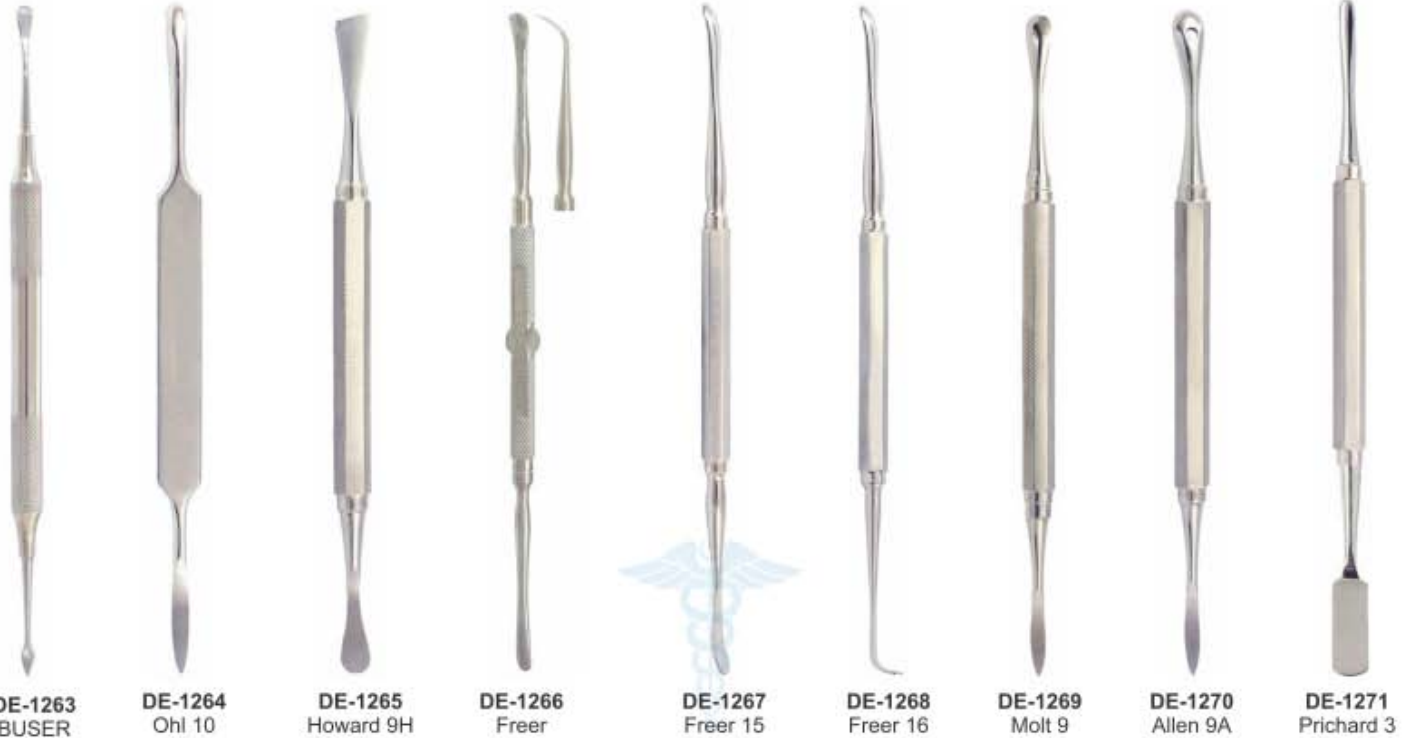

DE-1263
BUSER

DE-1264
Ohl 10

DE-1265
Howard 9H

DE-1266
Freer

DE-1267
Freer 15

DE-1268
Freer 16

DE-1269
Molt 9

DE-1270
Allen 9A

DE-1271
Prichard 3



DE-1272
Seldin 23



DE-1273
Goldman-Fox
14



DE-1274
P 24G



DE-1275



DE-127A



DE-127B

Raspator, Raspatory
Length 175 mm,



DE-1276



DE-1276A



DE-1276B

Raspator, Williger
Length 170 mm, different widths
(4 mm, 5 mm or 7 mm).





Behind Every Smile is a Story

- QUALITY - ЯКІСТЬ
- PRECISION - ТОЧНІСТЬ
- ACCURACY - ПРАВИЛЬНІСТЬ
- DURABILITY - ЗНОСОСТІЙКІСТЬ

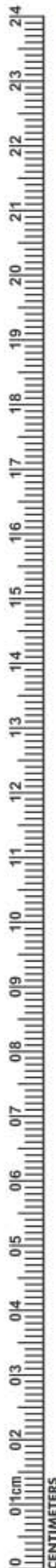

ORTHODONTIC INSTRUMENTS

AllWell Instruments co.
The name of Health Care Instruments



- Инструменты ортодонтические
- Instrumentos Ortodonticos
- Orthodontische Instrumente
- Инструменти ортодонтични
- Instruments Orthodontiques
- ادوات تقويم الاسنان



DE-1277
Aluminum Height Gauge 0.22



DE-1278
Aluminum Height Gauge 0.18



DE-1279
Bone Bracket Gauge



DE-1280
Bone Thickness Gauge
40mm, 180mm



DE-1281 OSTEOMETER
Measuring Forceps For Jaw Ridge Width measurement, scale on both sides, rustfree, autoclavable



DE-1282
Direct bonding bracket holders, 135mm



DE-1283
Deluxe Bracket Holder Tweezers



DE-1284
Direct bonding bracket holders, 136mm



DE-1285
Direct Bond Bracket Holder Tweezers, Small Tip



DE-1286
Direct bonding bracket holders, 140mm



DE-1287
Direct bonding bracket holders, 135mm



DE-1288
Direct Bonding Bracket Holders, 140mm





- Инструменты ортодонтические
- Instrumentos Ortodonticos
- Orthodontische Instrumente
- Инструменти ортодонтични
- Instruments Orthodontiques
- أدوات تقويم الأسنان



DE-1289
Band seater auto cleavable



DE-1290
Ortho light scaler double ended



DE-1291
Ortho light scaler double ended



DE-1292
Ortho light scaler double ended



DE-1293
Twiel-on elastic module instrument



DE-1294
Twiel-on elastic module instrument



DE-1295
Schure Band Seater



DE-1296
Ortho light scaler



DE-1297
Ortho light scaler



DE-1298
Ortho light scaler heavy



DE-1299
Ortho instrument



DE-1300
Ortho instrument



DE-1301
Ortho Light Band Pusher Scaler



ORTHODONTIC INSTRUMENTS

AllWell Instruments co.
The name of Health Care Instruments



- Инструменты ортодонтические
- Instrumentos Ortodonticos
- Orthodontische Instrumente
- Инструменти ортодонтични
- Instruments Orthodontiques
- أدوات تقويم الأسنان



DE-1302
Ortho Light double ended
ligature director



DE-1303
Ortho Light double ended
ligature director scaler



DE-1304
Ortho Light double ended ligature scaler director tivate coil spring
are remove modules with one instruments



DE-1305
Ortho band pusher scaler



DE-1306
Ortho Light Band Pusher Scaler



DE-1307
Ortho ligature director single ended



DE-1308
Ortho Light double ended ligature
director scaler



DE-1309
Ortho Light double ended ligature scaler/director
tivate coil spring are remove modules with one instruments



DE-1310
Ortho Light double ended ligature director



DE-1311
Ortholite Ligature Director Scaler



DE-1312
Ortho light ligature director double ended



DE-1313
Double ended cement spatula



DE-1314
Ortho light scaler single ended





- Щипцы для ортодонтии и протезирования
- Pincers pour l'orthodontie et la prothèse
- Zangen für Kieferorthopädie und Prothetik
- Щипці для ортодонції та протезування
- Alicates para ortodoncia y prótesis
- كمانشة لتقويم الأسنان بروسشيس

BOX JOINT PLIERS



DE-1315
Universal Dolphin Style
Wire Bending & cutting pliers



DE-1316 Band Removing Plier
The curved blade of the band removing plier can strip easily and gently remove directly to the tooth. Length 130mm



DE-1317
Tweed Loop forming Pliers



DE-1318
How Plier curved
Universally usable tool for the multiband technology for wires up to .028". Length 130mm



DE-1319 How Plier
Universally usable tool for the multiband technology for wires up to .028". Length 135mm



DE-1320
Nance Loop forming Pliers



DE-1321
Bracket Removing Plier curved
Bracket Removing Plier curved for easy removal of brackets in the posterior region. Length 130mm



DE-1322
Young Wire Bending & Loop Forming Pliers



DE-1323
Wire Bending & Loop Forming Pliers



DE-1324
Adams, small wire bending and loop forming Pliers



DE-1325
Bracket Removing Plier Round Box
Bracket removing plier for comfortable and quick removal of the brackets. Length 135mm



DE-1326
Weingart Plier medium
Weingart plier that are ideal due to their curved tip for setting sheets and is capable of bending the ends. Length 145mm



PLIERS FOR ORTHODONTICS & PROSTHETICS

AllWell Instruments co.
The name of Health Care Instruments



- Щипцы для ортодонтии и протезирования
- Pincers pour l'orthodontie et la prothèse
- Zangen für Kieferorthopädie und Prothetik
- Щипці для ортодонції та протезування
- Alicates para ortodoncia y prótesis
- كمانشة لتقويم الأسنان بروتستیس

BOX JOINT PLIERS

DE-1327 Adams Plier Round Box

Adams pliers for bending wire arches and bends right angles for wires up to .022", .025 tip to beak. Length 125mm



DE-1333 Adams Plier

Adams pliers for bending wire arches and bends right angles for wires up to .022", .025 tip to beak. Length 125mm



DE-1328

Falcon Beak
Contouring Pliers.



DE-1334

Tweed
Loop Formin Pliers



DE-1329

wires up to 0.020" / 0.7mm.



DE-1335 Bird Beak Plier Standard

Bird Beak Wire bending plier without notches, which is suitable as a universal utility tool. Length 125mm



DE-1330

Johnson Contouring
Pliers



DE-1336

Mini Ligature cutters



DE-1331 Aderer

Large wire bending
and loop forming pliers



DE-1337 Small

Fluch-cut distal and cutting Pliers
with safety hold fitted with
un-breakable, corrosion
resistant and durable
stainless steel tips



DE-1332

Tweed / angle rectangular
arch forming & Torquing pliers



DE-1338 Large

Fluch-cut distal and cutting Pliers
with safety hold fitted with
un-breakable, corrosion
resistant and durable
stainless steel tips





- Щипцы для ортодонтии и протезирования
- Pincers pour l'orthodontie et la prothèse
- Zangen für Kieferorthopädie und Prothetik
- Щипці для ортодонції та протезування
- Alicates para ortodoncia y prótesis
- كمانشة لتقويم الأسنان بروسشيس

BOX JOINT PLIERS

DE-1339
Tweed / Angel
1.78mm (.070") wide tips arch forming and torquing pliers



DE-1345
Contouring Plier



DE-1340
Tweed / Angel
1.78mm (.070") wide tips arch forming and torquing pliers



DE-1346
Bands & Crowns Plier
in order to skirt



DE-1341
Lingual / Palatal arch
forming pliers



DE-1347
Ligature Forming Pliers



DE-1342
Aderer
Facebow loop forming Pliers



DE-1348
for double back and triple back bands in 0.30" / 0.76mm & 0.36" / 0.91mm lingual arch wires



DE-1343
Waldsavs wire bending and cutting pliers



DE-1349
Bird Beak Wire Bending & cutting pliers



DE-1344 Aderer Plier
For the manufacturing of appliances and activation of wires for wires up to .030" .fine tip and up to .036" mean tip. Length 130mm



DE-1350
Weingart Plier medium
Weingart plier that are ideal due to their curved tip for setting sheets and is capable of bending the ends. Length 145mm



PLIERS FOR ORTHODONTICS & PROSTHETICS

AllWell Instruments co.
The name of Health Care Instruments



- Щипцы для ортодонтии и протезирования
- Pincas pour l'orthodontie et la prothèse
- Zangen für Kieferorthopädie und Prothetik
- Щипці для ортодонції та протезування
- Alicates para ortodoncia y prótesis
- كمانشة لتقويم الأسنان بروسٹیٹیس

L-KEY JOINT PLIERS



DE-1351
Distal end cutter with safety hold, mini head, long handles.
fitted with un-breakable, corrosion resistant and durable stainless steel tips

- 0.30 mm to 0.50 mm (.012" to .020")
- Max. 0.46 mm x 0.64 mm (.018" x .025")
- ⊗ 0.38 mm to 0.53 mm (.0155" to .0215")
- ⊗ Max. 0.53 mm x 0.64 mm (.021" x .025")



DE-1352
Flush-cut distal end cutter with safety hold fitted with un-breakable, corrosion resistant and durable stainless steel tips

- 0.30 mm to 0.50 mm (.012" to .020")
- Max. 0.46 mm x 0.64 mm (.018" to .025")



DE-1353
Soft wire and ligature cutter, Mini fitted with un-breakable, corrosion resistant and durable stainless steel tips

- ⊗ .25 mm to .38 mm (.010" to .015")



DE-1354
Soft wire and ligature cutter, standard fitted with un-breakable, corrosion resistant and durable stainless steel tips

- ⊗ .25 mm to .38 mm (.010" to .015")



DE-1355
Soft wire and ligature cutter, 15° angled fitted with un-breakable, corrosion resistant and durable stainless steel tips

- ⊗ .25 mm to .38 mm (.010" to .015")



DE-1356
Soft wire and ligature cutter, 45° angled fitted with un-breakable, corrosion resistant and durable stainless steel tips

- ⊗ .25 mm to .38 mm (.010" to .015")



DE-1357
Hard wire cutter, straight Fitted with un-breakable, corrosion resistant and durable stainless steel tips

- 0.30 mm to 0.50 mm (.012" to .020")
- Max. 0.56 mm x 0.71 mm (.022" x .028")



DE-1358
Hard wire cutter, 15° angled Fitted with un-breakable, corrosion resistant and durable stainless steel tips

- 0.30 mm to 0.50 mm (.012" to .020")
- Max. 0.56 mm x 0.71 mm (.022" x .028")



DE-1359
Hard wire cutter, 15° angled Non-autoclavable

- 0.30 mm to 0.50 mm (.012" to .020")
- Max. 0.56 mm x 0.71 mm (.022" x .028")





- Щипцы для ортодонтии и протезирования
- Pincers pour l'orthodontie et la prothèse
- Zangen für Kieferorthopädie und Prothetik

- Щипці для ортодонції та протезування
- Alicates para ortodoncia y prótesis
- كمانشة لتقويم الأسنان بروسشيس

L-KEY JOINT PLIERS

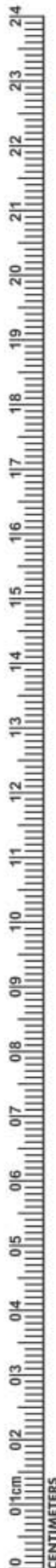

DE-1360
Band removing pliers



DE-1365
Weingart-mini
Utility Pliers

- 0.30 mm to 0.50 mm (.012" to .020")
- Max 0.56 mm x 0.71 mm (.022" x .028")



DE-1361
Bracket removing pliers angled

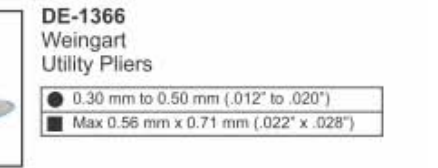

DE-1366
Weingart
Utility Pliers

- 0.30 mm to 0.50 mm (.012" to .020")
- Max 0.56 mm x 0.71 mm (.022" x .028")



DE-1362
Bracket removing pliers straight



DE-1367
How Straight
Utility Pliers

- 0.30 mm to 0.50 mm (.012" to .020")
- Max 0.56 mm x 0.71 mm (.022" x .028")



DE-1363
Bracket removing pliers with plastic tip

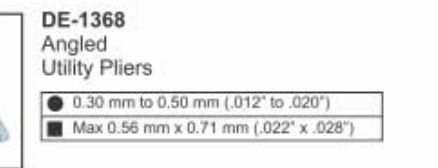

DE-1368
Angled
Utility Pliers

- 0.30 mm to 0.50 mm (.012" to .020")
- Max 0.56 mm x 0.71 mm (.022" x .028")



DE-1364
Adhesive removing pliers



DE-1369
Wire bending and loop forming pliers
Angled (Bird beak)

- 0.30 mm to 0.50 mm (.012" to .020")
- Max 0.56 mm x 0.71 mm (.022" x .028")

PLIERS FOR ORTHODONTICS & PROSTHETICS



- Щипцы для ортодонтии и протезирования
- Pincers pour l'orthodontie et la prothèse
- Zangen für Kieferorthopädie und Prothetik
- Щипці для ортодонції та протезування
- Alicates para ortodoncia y prótesis
- كمشة لتقويم الأسنان بروسيثيس

L-KEY JOINT PLIERS



DE-1370
Multi-purpose pliers, bird beak,
De la rosa and cutter in one

- 0.30 mm to 0.50 mm (.012" to .020")
- Max. 0.46 mm x 0.56 mm (.018" x .022")



DE-1375
Stop pliers V-Bebd - 1mm

- 0.30 mm to 0.50 mm (.012" to .020")
- Max. 0.43 mm x 0.56 mm (.017" x .028")



DE-1371
Cinch Back / tie back
Distal end bending pliers

- 0.30 mm to 0.50 mm (.012" to .020")
- Max. 0.56 mm x 0.71 mm (.022" x .028")



DE-1376
Lingual / palatal arch forming plies

- 0.76 mm (.030") / 0.91 mm (.036")



DE-1372
Hammer head
Distal end bending pliers

- 0.30 mm to 0.50 mm (.012" to .020")
- Max. 0.56 mm x 0.71 mm (.022" x .028")



DE-1377
Torquing pliers set



DE-1373
Nance
Loop forming pliers

- 0.36 mm to 0.71 mm (.014" to .028")
- Max. 0.56 mm x 0.71 mm (.022" x .028")



DE-1378
Tweed / angel
Rectangular arch forming and
torquing pliers

- 0.30 mm to 0.71 mm (.012" to .028")
- Max. 0.56 mm x 0.71 mm (.022" x .028")



DE-1374
Detailing step pliers / Bayonet
bending pliers - 1mm

- 0.30 mm to 0.50 mm (.012" to .020")
- Max. 0.56 mm x 0.71 mm (.022" x .028")



DE-1379
Surgical ball hook crimping pliers,
angled



DE-1380
Surgical ball hook crimping
pliers, straight





- Щипцы для ортодонтии и протезирования
- Pincas pour l'orthodontie et la prothèse
- Zangen für Kieferorthopädie und Prothetik
- Щипці для ортодонції та протезування
- Alicates para ortodoncia y prótesis
- كمانشة لتقويم الأسنان بروسشیشيس

L-KEY JOINT PLIERS



DE-1381
Aderer Clamp three jaw wire bending plier for contouring and bending wire up to .30"/.76mm.



DE-1387
Falcon beak contouring plier.

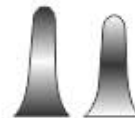

DE-1382
Bird beak plier for bending round, square and rectangle wire up to .30"/.76mm.

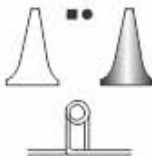

DE-1388
For placement and removal of arch wires, pins and other auxiliaries.



DE-1383
Bird beak plier for light wire bending round, square and rectangular up to .016"/0.41mm.

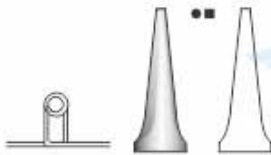

DE-1389
For placement and removal of arch wires, pins and other auxiliaries in angle design



DE-1384
Double Rounded jaw bending pliers, hooks and wire up to .020"/0.51mm.

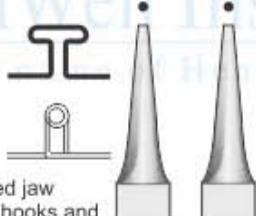

DE-1390
contouring Plier.



DE-1385
Adams pliers for hooks and bending wire up to .030"/0.76mm.



DE-1391
Bending plier. In order to skirt molares bands. With grooved. Recommended wire. 016", 018" and 022" 0.41mm, 0.46mm and 0.56mm



DE-1392
Loop forming in four length 3,4,5 & 6 mm wire capacity 0.22", 56mm.



DE-1386
Johnson pliers for crown band contouring



DE-1393
Arch bending plier design for convenient handling of square or rectangular wire, .020" / 0.51mm.

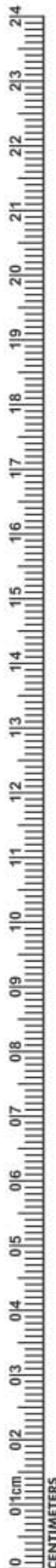

PLIERS FOR ORTHODONTICS & PROSTHETICS

AllWell Instruments co.
The name of Health Care Instruments



- Щипцы для ортодонтии и протезирования
- Pincers pour l'orthodontie et la prothèse
- Zangen für Kieferorthopädie und Prothetik
- Щипці для ортодонції та протезування
- Alicates para ortodoncia y prótesis
- كمانشة لتقويم الأسنان بروتستيتيس

LAP & L-KEY JOINT PLIERS



DE-1394
In order to skirt
bands and crowns.



DE-1395
Wires up to
.020" / 0.7mm.

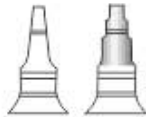

DE-1396
Round and concave plier
for loop forming and banding
wire up to .20" / .051mm.



DE-1397
Bending for round square
or rectangular wire up
to 0.30"/0.76mm



DE-1398
for double back and triple
back bands in 0.30" / .76mm
& 0.36" / .91mm lingual arch wires.



DE-1399
Detailing step plier double-sided
offset beak permits bayonet bends.
Creates right hand or left hand
step-up or stepdown at 1/2, 3/4, or
1mm increments.



DE-1400
"V" bend stop special design makes
1mm "v" bends to shorten archwires
or provide a positive stop. Excellent
for placing stops in nitanium wires.
For round or rectangular wires up to .025"



DE-1401
Angle how plier efficient utility plier
with serrated beaks for a firm grip.
45 angled tips to access hand ro
reach areas.



DE-1402
Weingardt plier serrated tips hold
wires firmly at a convenient working
angle. Tapered beaks fit easily
between brackets and hard to reach
areas. Our most popular utility plier.



DE-1415
Pin & Ligature Cutters
TC.



DE-1416
Mini Pin & Ligature
Cutter TC.



DE-1417
Standard Ligature
Cutter TC.



DE-1418
V Bend Stop Plier
TC.



DE-1419
Angled Direct Bond Bracket
Remover TC.



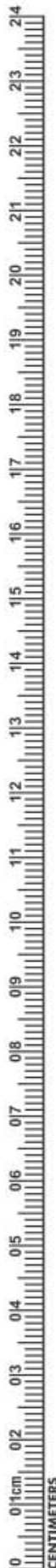

DE-1420
Distal end Cutter, Safety Hold Plier
(Ideal for Cutting Wire) TC.



DE-1421
Hook Crimping Plier Angled
Straight TC.



DE-1422
3 Prong Clasp Adjustable
Plier TC.



DE-1423
Utility Plier Weingart TC.



DE-1424
Direct Bracket Remover
TC.



DE-1425
Straight Direct Bond Bracket
Remover TC.



DE-1426
Pin Holding Plier TC.



DE-1427
Hard wire cutters



DE-1428
Elastic Separating Plier
Round Handle



DE-1429
Elastic
Separating Plier



DE-1430
DE-1431
Smaha
Elastomeric
ligature
placing forceps
140 mm



DE-1432
Elastomeric
ligature placing
forceps with
groove
Falcon 140 mm



DE-1433
Elastomeric
ligature placing
forceps with
groove
Falcon 140 mm





Normal Anatomy – Dental Implants

Bone Level Normal
(No Bone Loss)

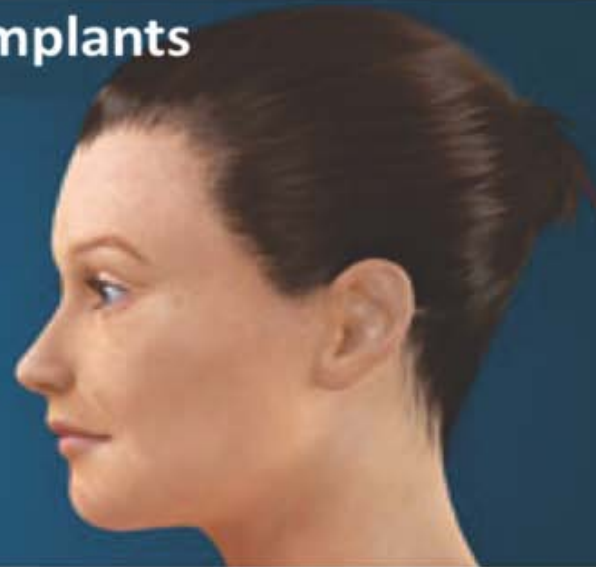
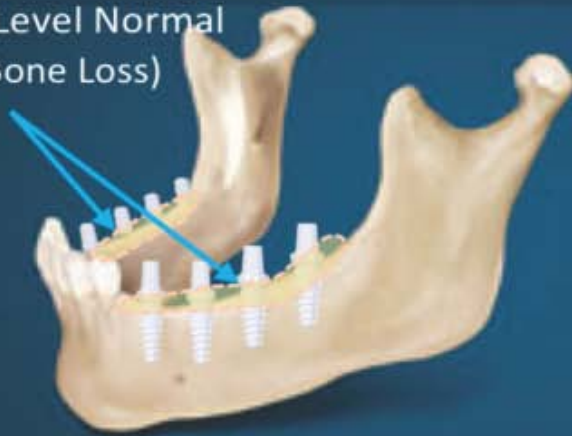

Maxilla
(upper jaw)

Maxilla
(upper jaw)

Nerve (controls
feeling in the chin,
gum, teeth, and lip)

Mandible
(lower jaw)

Impacted
wisdom
teeth





- Инструменты для имплантологии
- Instrumentologie
- Implantsologie
- Инструменти для імплантології
- Implantologia
- زراعة الأسنان

IMPLANT GAGES

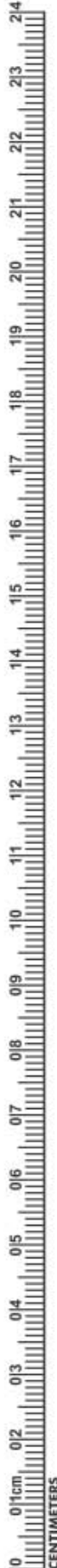

DE-1434 Multifunctional Meter
Length 90 mm, different sizes, 8-10-11mm, corrosion-resistant

DE-1435 Multifunctional Meter
Length 90 mm, different sizes, 5-13-15-17 mm, corrosion-resistant

DE-1436 Measuring Probe
Length 170 mm, hand shape or flexible (6-8-10-14-16 mm), corrosion-resistant

DE-1437

DE-1438

DE-1439

DE-1440

IMPLANT GAGES



DE-1441

DE-1442

DE-1443



- Инструменты для имплантологии
 - Implantologie
 - Implantologie
- Інструменти для імплантології
 - Implantologia
 - زراعة الأسنان



DE-1444
Clamp, Osteometer
Length about 155 mm,
ridge width measurement,
two-sided scale,
measuring
range 0 - 25 mm



DE-1445
Measuring Loop
straight length 90 mm,
measuring range
0 - 40 mm,



DE-1446
Measuring Loop
angled, length 90 mm,
measuring range
0 - 40 mm,



DE-1447
Measuring loop, Castroviejo
angled, length 175 mm,
measuring range 0 - 40 mm,
with window



DE-1448
Boley Gauge
Stainless Steel



DE-1449
Measuring Loop
angled, length
175 mm,
measuring range
0 - 40 mm,



DE-1450
Measuring Loop
straight length
175 mm,
measuring range
0 - 40 mm,



DE-1451
Fig. 1
Iwanson
spring caliper
For metal and
porcelain.



DE-1452
Fig. 2
Iwanson
spring caliper
For wax.



DE-1453
Bone Thickness Gauge
40mm, 180mm



DE-1454
Gauge
for measuring
distances
(0 - 90 mm),



AllWell Instruments co.
The name of Health Care Instruments



- Инструменты для имплантологии
- Implantologie
- Implantologie
- Інструменти для імплантології
- Implantologia
- زراعة الأسنان

BLACK TITANIUM COLOUR COATED INSTRUMENTS

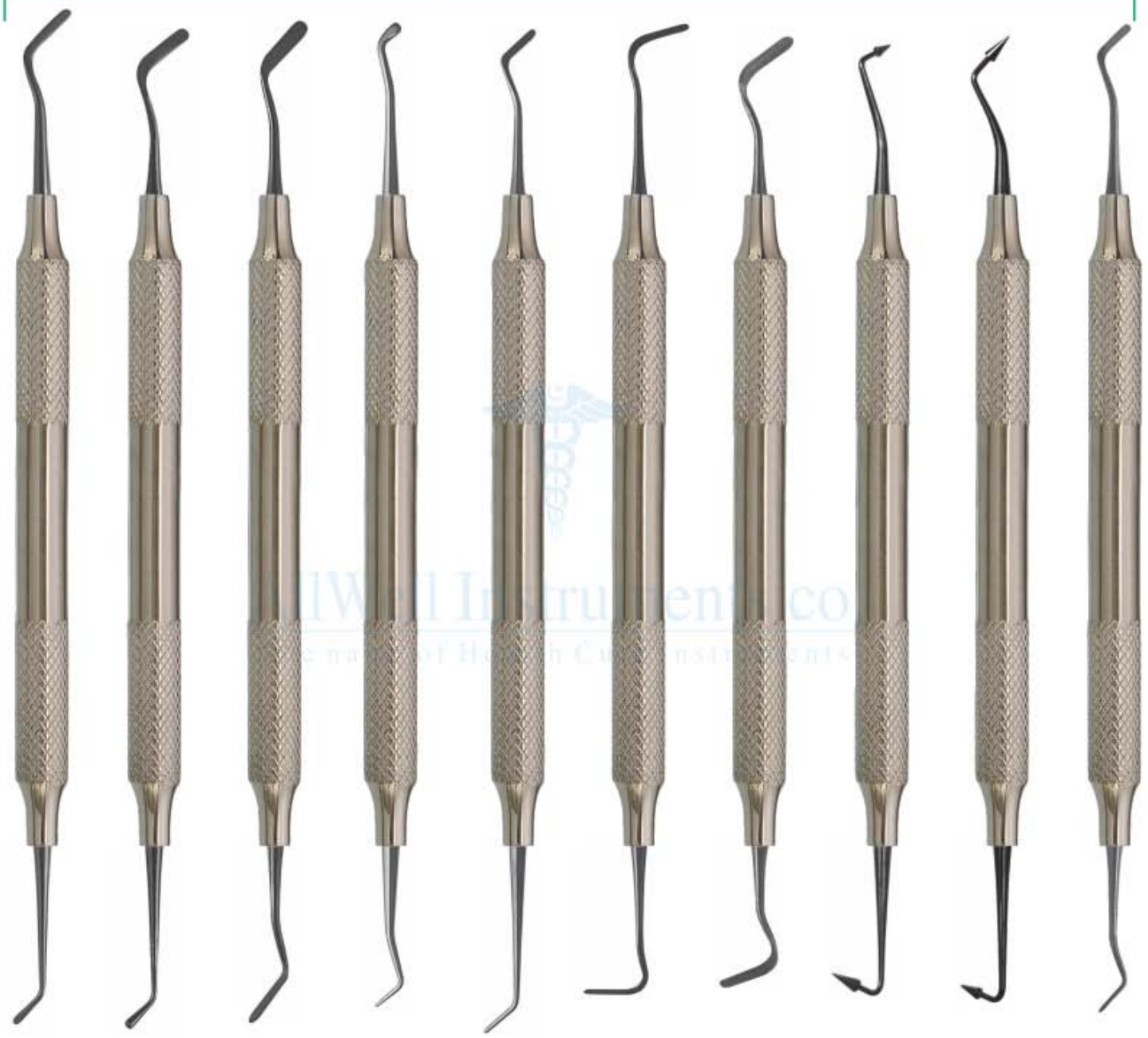
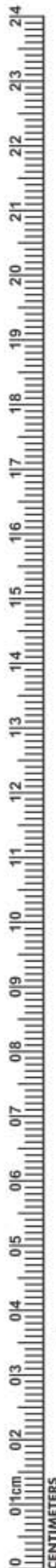

DE-1455 #1 DE-1456 #2 DE-1457 #3 Extra-Flex DE-1458 Micro-Mini DE-1459 Mini 1 DE-1460 Mini 4 Extra-Flex DE-1461 #4 Extra-Flex DE-1462 #5 Flexi-Thin DE-1463 #6 Flexi-Thin DE-1464 Mini 3 Extra-Flex



- Инструменты для имплантологии
 - Implantologie
 - Implantologie
- Інструменти для імплантології
 - Implantologia
 - زراعة الأسنان

BLACK TITANIUM COLOUR COATED INSTRUMENTS

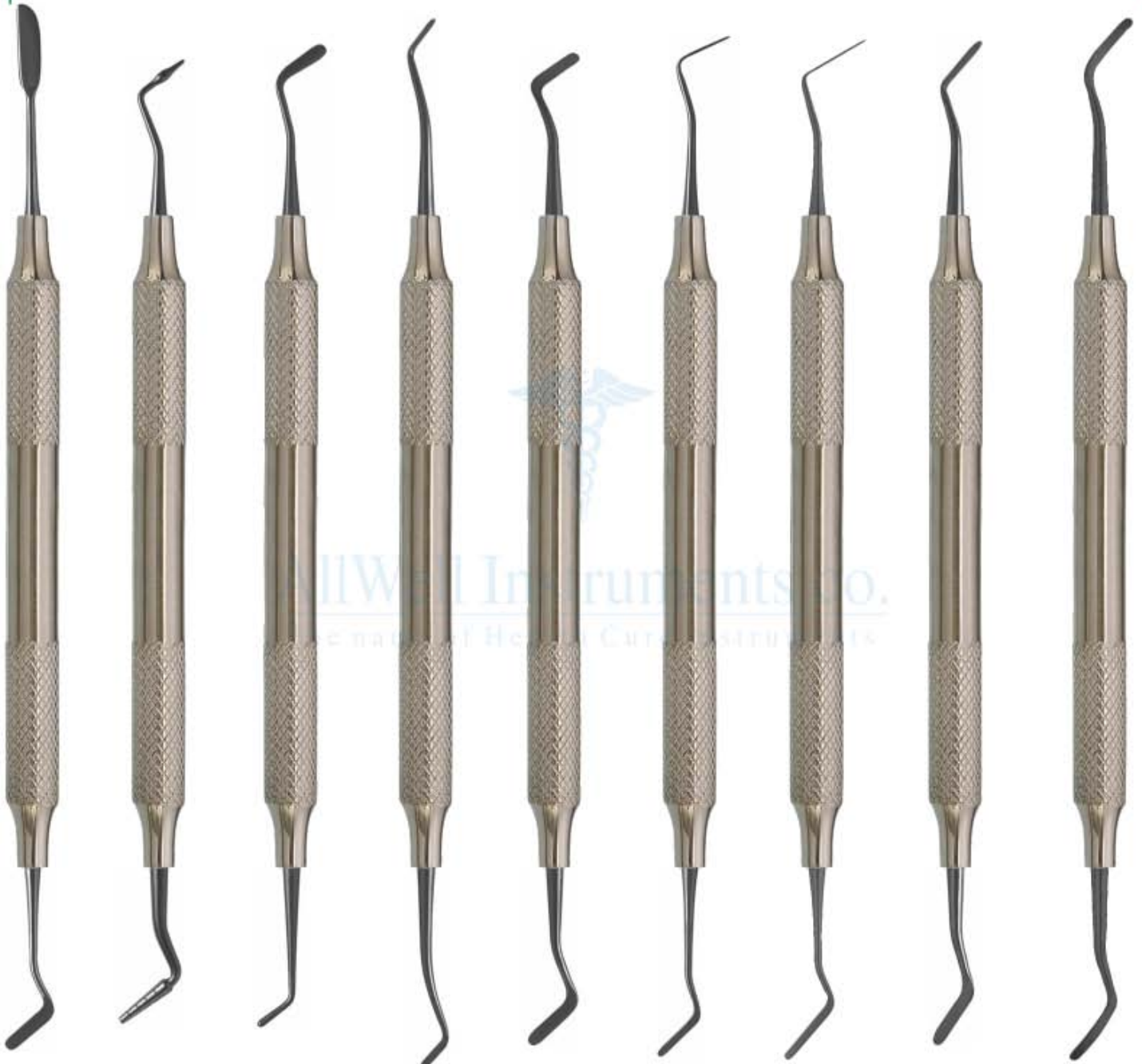

DE-1465
AB1
Boghosian

DE-1466
AB2
Boghosian

DE-1467
W3

DE-1468
8A

DE-1469
4/5
Gregg

DE-1470
Interproximal
Carver

DE-1471
Interproximal
Carver, Long

DE-1472
A6

DE-1473
Contouring
instrument





- Инструменты для имплантологии
- Implantologie
- Implantologie
- Инструменти для імплантології
- Implantologia
- زراعة الأسنان

BLACK TITANIUM COLOUR COATED INSTRUMENTS

BURNISHERS

FREEDMAN BURNISHERS

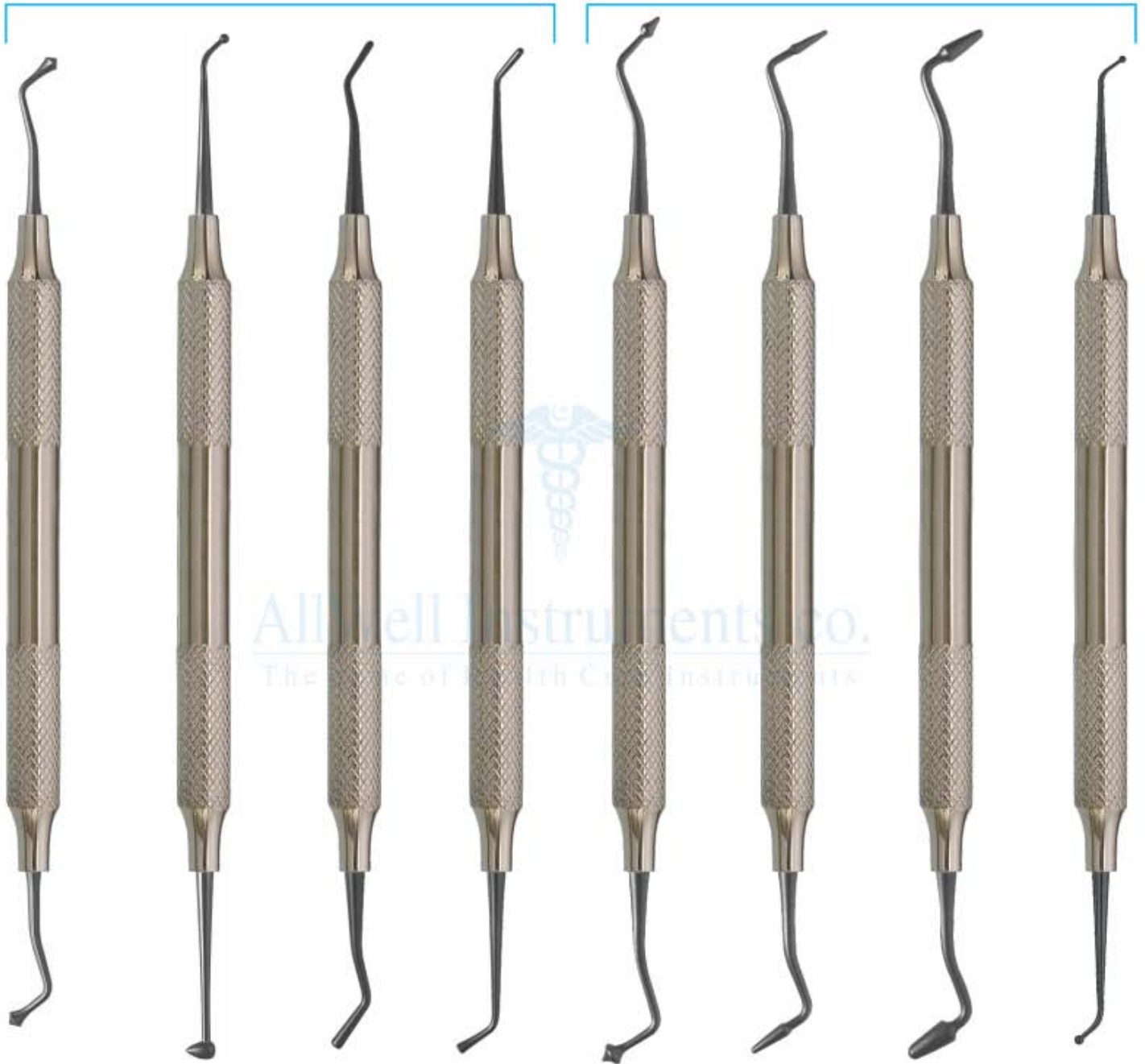

DE-1474
21B

DE-1475
27/29

DE-1476
2
Ladmore

DE-1477
3
Ladmore

DE-1478
Freedman
"Duckhead"

DE-1479
Freedman
Small Contact
Forming

DE-1480
Freedman
Large Contact
Forming

DE-1481
Small/
Medium Ball
Burnisher



- Инструменты для имплантологии
 - Implantologie
 - Implantologie
- Інструменти для імплантології
 - Implantoloia
 - زراعة الأسنان

BLACK TITANIUM COLOUR COATED INSTRUMENTS

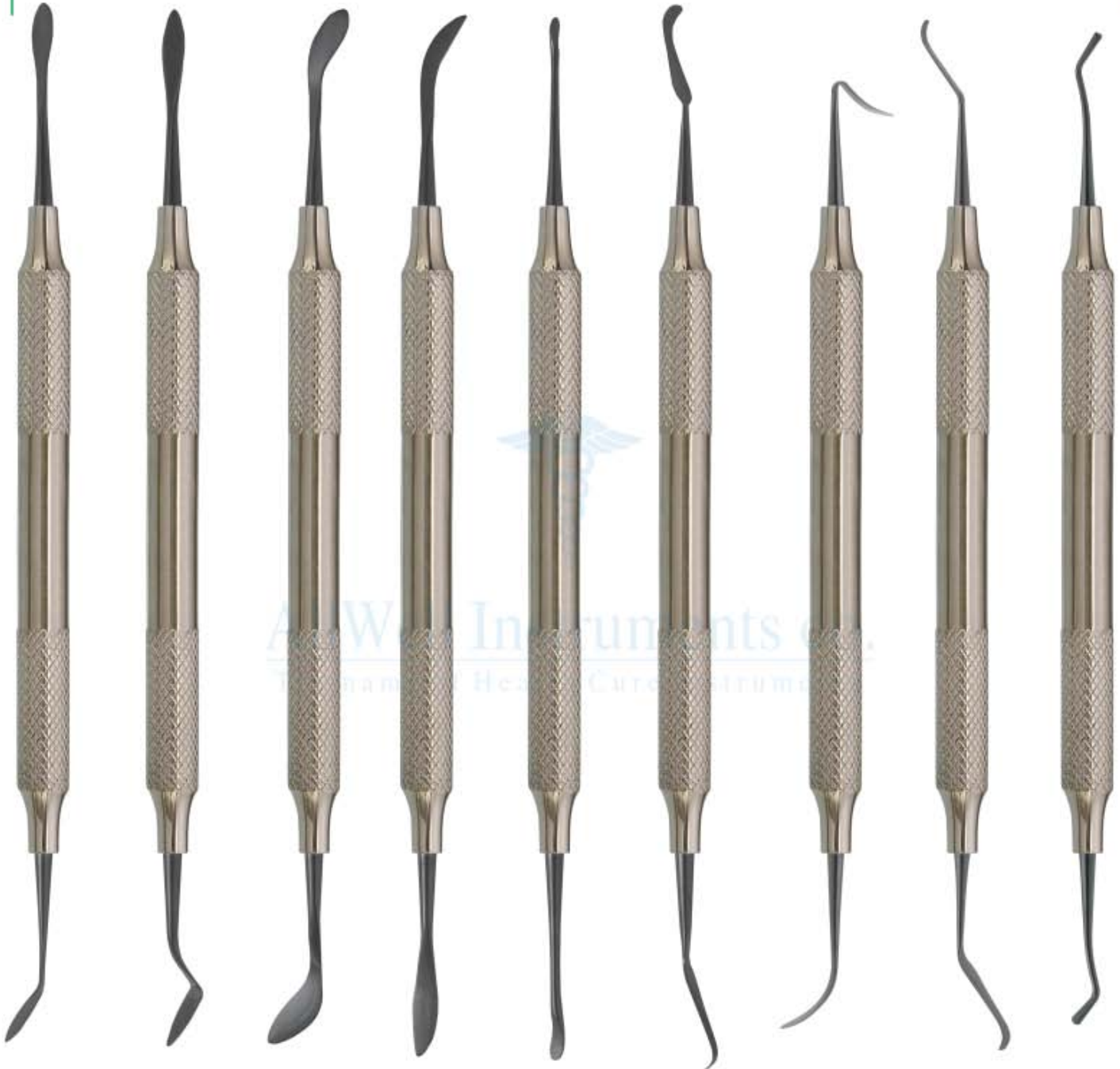

DE-1482
A
Cosmetic
Contouring

DE-1483
B
Cosmetic
Contouring

DE-1484
C
Cosmetic
Contouring

DE-1485
D
Cosmetic
Contouring

DE-1486
E
Cosmetic
Contouring

DE-1487
F
Cosmetic
Contouring

DE-1488
Marginal Ridge
& Embrasure
Shaping Instrument

DE-1489
Occlusal
Anatomy
Instrument

DE-1490
Composite
Packing
Instrument





- Инструменты для имплантологии
- Implantologie
- Implantsologie
- Инструменти для імплантології
- Implantologia
- زراعة الأسنان

BLACK TITANIUM COLOUR COATED INSTRUMENTS

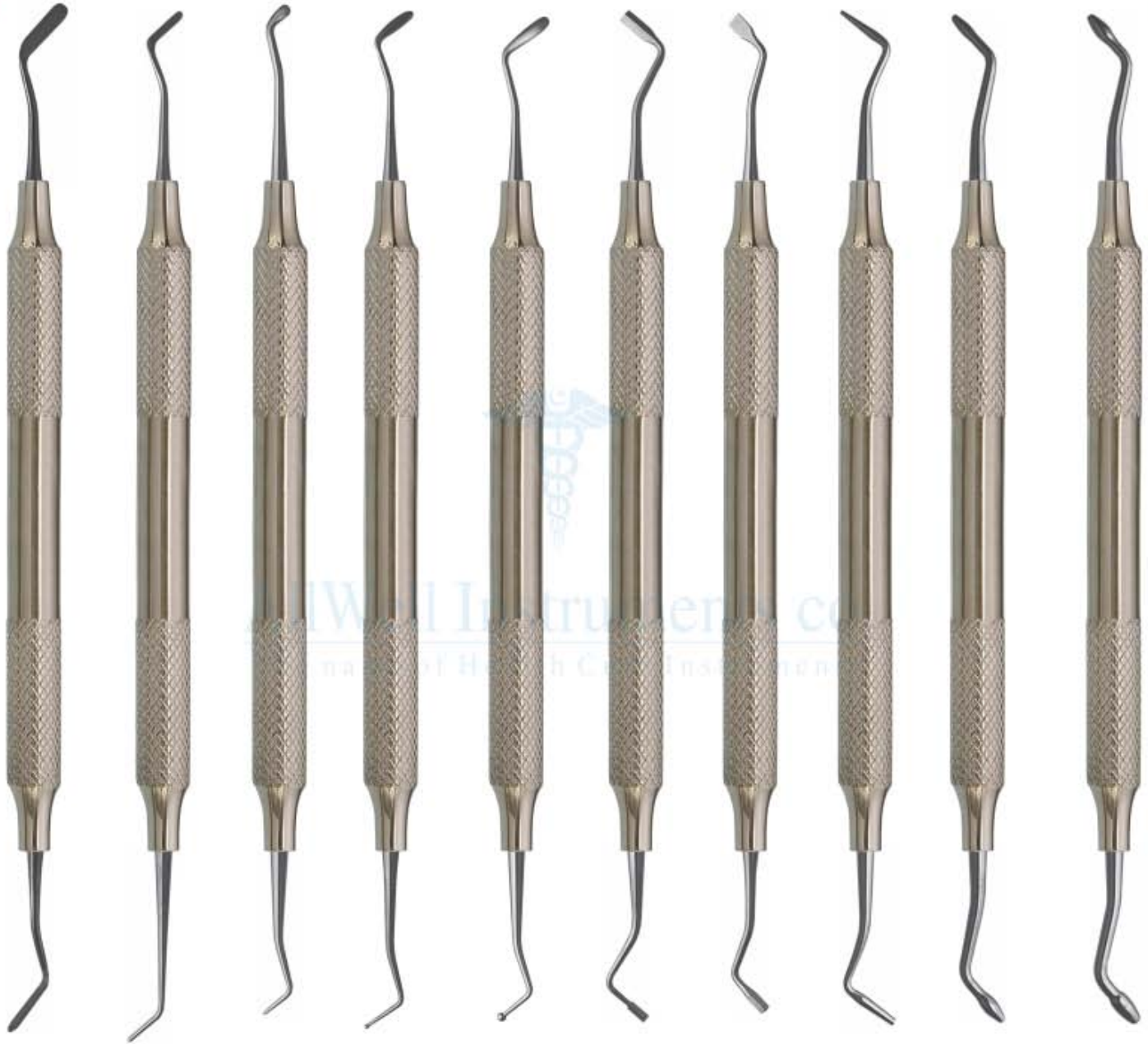

DE-1491 #3 Extra-Flex	DE-1492 Mini 1	DE-1493 Micro-Mini	DE-1494 Medium Placing/ Condensing	DE-1495 Large Placing/ Condensing	DE-1496 OT Tanner	DE-1497 3 Hollenback	DE-1498 5A	DE-1499 Small/Medium Contact Forming	DE-1500 Medium/Large Contact Forming
------------------------------------	--------------------------	------------------------------	--	---	--------------------------------	-----------------------------------	----------------------	--	--



- Инструменты для имплантологии
 - Implantologie
 - Implantologie
- Інструменти для імплантології
 - Implantologia
 - زراعة الأسنان

SINUS LIFT INSTRUMENTS HOLLOW HANDLE 9.5MM LENGTH 170MM



DE-1501
Sinus Lift Elevator

DE-1502
Sinus Lift Elevator

DE-1503
Sinus Lift Elevator

DE-1504
Sinus Lift Elevator

DE-1505
Sinus Lift Elevator





- Инструменты для имплантологии
- Implantologie
- Implantologie
- Інструменти для імплантології
- Implantologia
- زراعة الأسنان

SINUS LIFT INSTRUMENTS HOLLOW HANDLE 9.5MM LENGTH 170MM



DE-1506
Sinus Lift Elevator



DE-1507
Sinus Lift Elevator



DE-1508
Sinus Lift Elevator



DE-1509
Sinus Lift Elevator





- Инструменты для имплантологии
- Implantologie
- Implantologie
- Інструменти для імплантології
- Implantologia
- زراعة الأسنان

IMPLANT SINUS LIFT INSTRUMENTS HOLLOW HANDLE 9.5MM LENGTH 170MM



DE-1510
Acute 6577

DE-1511
Sinus1

DE-1512
Sinus2

DE-1513
Sinus3,
Obtuse 6578

DE-1514
Sinus4

DE-1515
Sinus5

DE-1516
Sinus6

DE-1517
Sinus7



- Инструменты для имплантологии
- Implantologie
- Implantologie
- Инструменти для імплантології
- Implantologia
- زراعة الأسنان

SINUS LIFT INSTRUMENTS HOLLOW HANDLE 9.5MM LENGTH 170MM

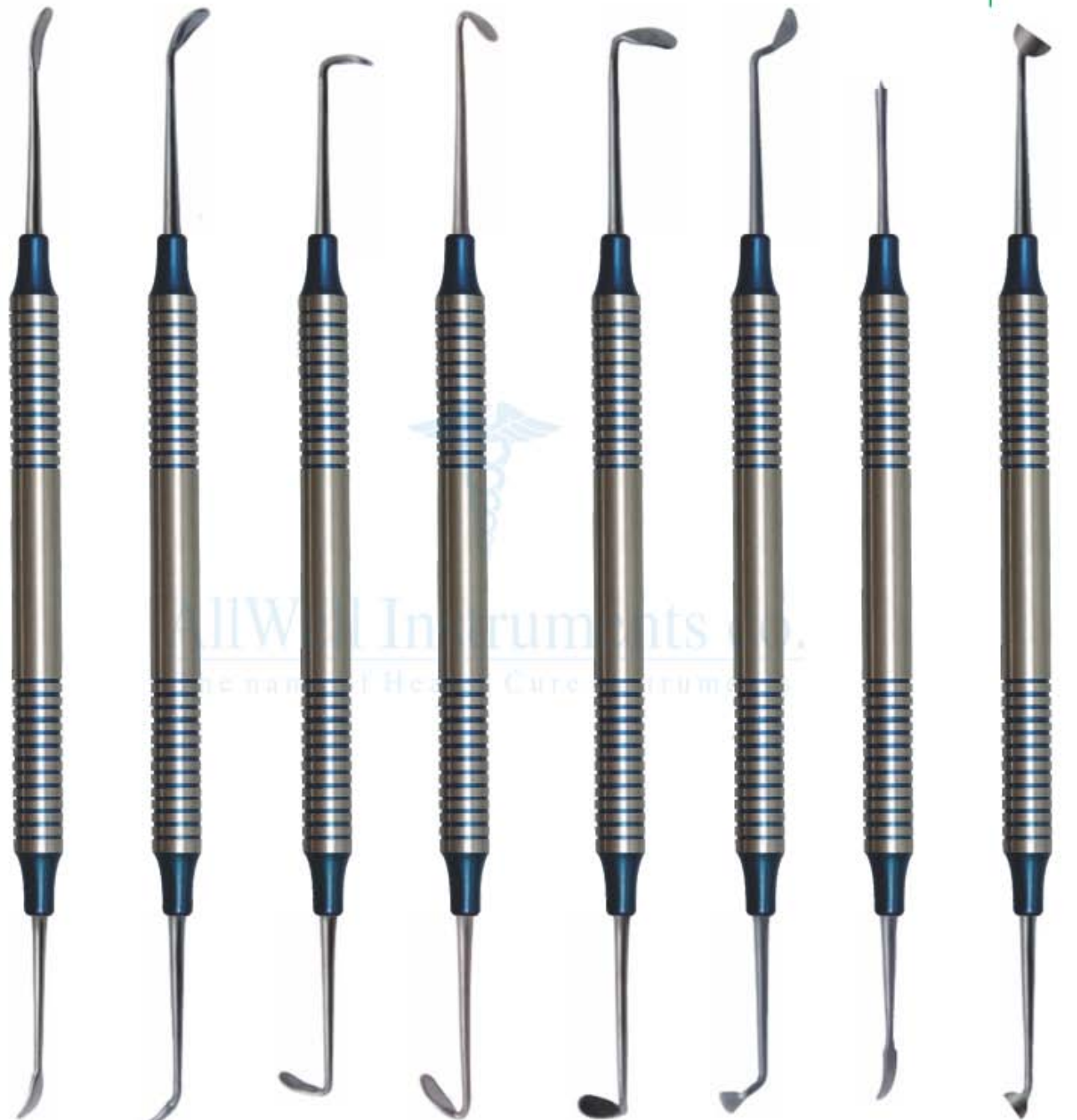

DE-1518
Sinuslift 1

DE-1519
Sinuslift 2

DE-1520
Sinuslift 3

DE-1521
Sinuslift 4

DE-1522
Sinuslift 5

DE-1523
Sinuslift 6

DE-1524
Membrane
3Positioning 1

DE-1525
Condenser 1



- Инструменты для имплантологии
- Implantologie
- Implantologie

- Инструменти для имплантології
- Implantologia
- زراعة الأسنان

Sinus Lift Instrument,
Flexible Sinus Lift instruments
reduce the risk of perforation of the
"Schneider's membrane"

Sinus Lift Elevator,
10 mm Straight grip
Length 175 mm, Sinus lift elevators, dull,
for gentle peeling and lifting the
Schneider membrane

Sinus lift instrument
10 mm Straight grip Length 180 mm,
Buser (B1, B2, B3) raspatories,
quality medical stainless steel,
corrosion-resistant



DE-1526
Fig. 1

DE-1527
Fig. 2

DE-1528
Fig. 3



DE-1529
Fig. 1

DE-1530
Fig. 2

DE-1531
Fig. 3



DE-1532
B01

DE-1533
B02

DE-1534
B03





- Инструменты для имплантологии
 - Implantologie
 - Implantologie
- Інструменти для імплантології
 - Implantologia
 - زراعة الأسنان

Sinus lift instrument 10 mm Straight grip Sinus lift elevators, blunt or sharply curved
(H01, H02, K03, K04, K78, K77)

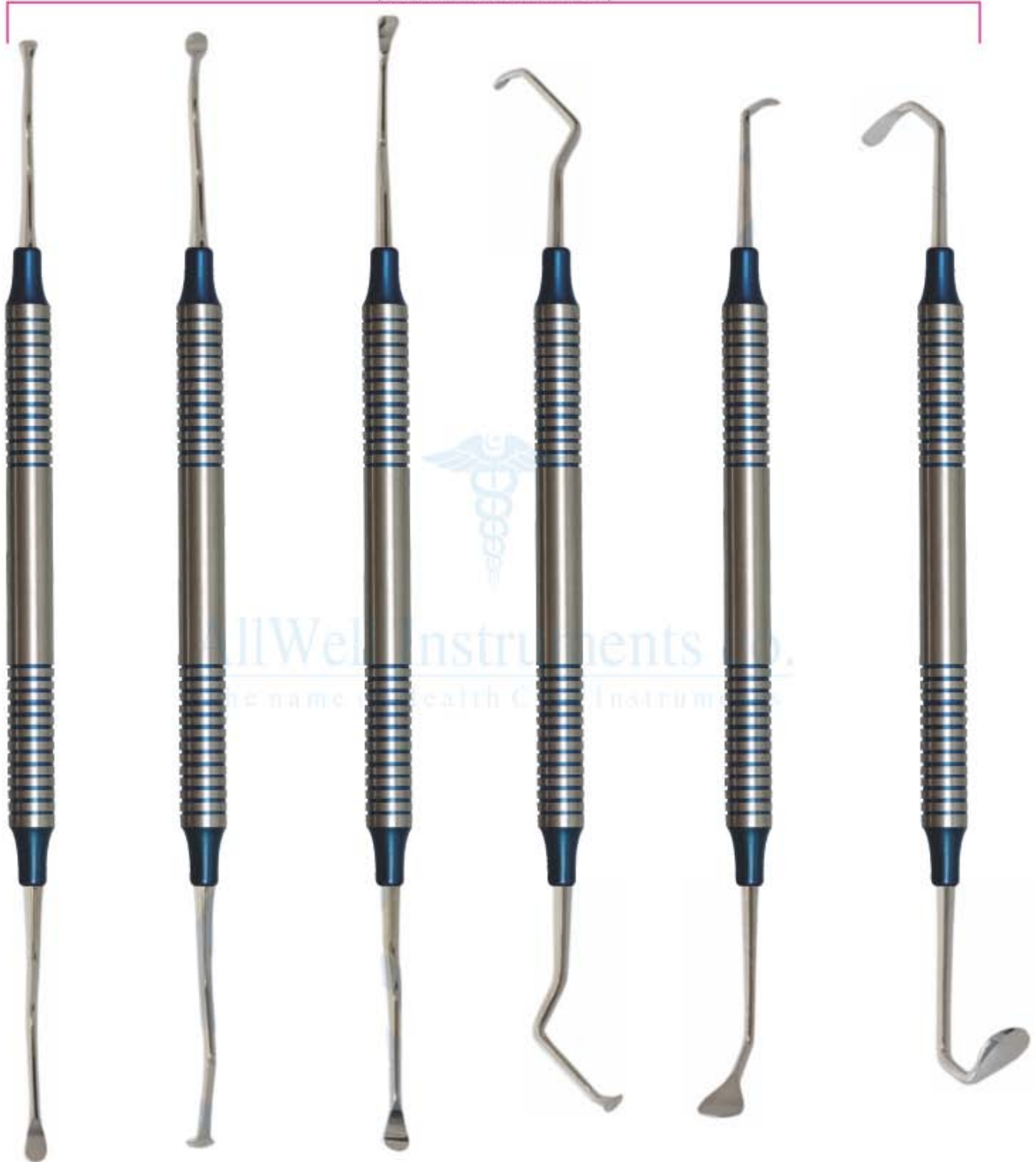

DE-1535
Sinus lift instrument
H01

DE-1536
Sinus lift instrument
H02

DE-1537
Sinus lift instrument
K03

DE-1538
Sinus lift instrument
K04

DE-1539
Sinus lift instrument
K78

DE-1540
Sinus lift instrument
K77





- Инструменты для имплантологии
- Implantologie
- Implantologie
- Інструменти для імплантології
- Implantologia
- زراعة الأسنان

SINUS LIFT INSTRUMENT

Sinus Lift Elevators, 10 mm Hollow Handle length 170mm Blunt Curved Set of 6 Pcs

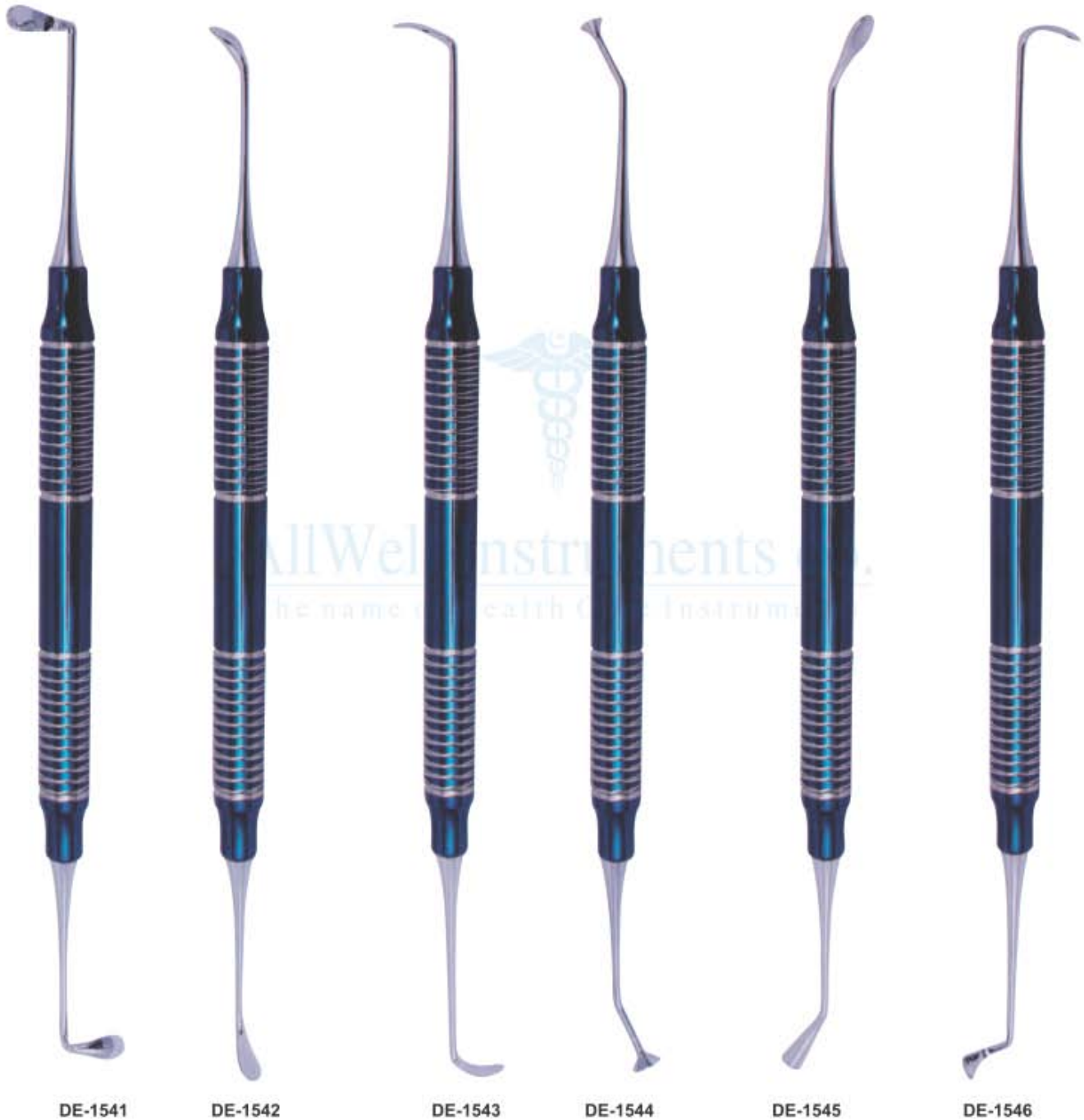

DE-1541

DE-1542

DE-1543

DE-1544

DE-1545

DE-1546



- Инструменты для имплантологии
- Implantologie
- Implantologie

- Інструменти для імплантології
- Implantologia
- زراعة الأسنان

IMPLANT SINUS LIFT INSTRUMENTS
PERIODONTAL SURGERY SURGICAL CHISELS
KRAMER NEVINS SINUS LIFT



DE-1547 TG



DE-1548 SOLT3/4



DE-1549 TGO



DE-1550 29K



DE-1551 FEDI4



DE-1552 OCH3



DE-1553 OCH4



DE-1554 FEDI1



DE-1555 FEDI2



DE-1556 FEDI3



DE-1557 Gf36

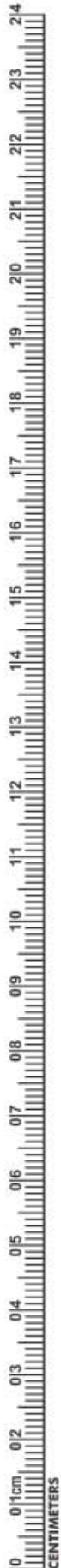



- Инструменты для имплантологии
- Implantologie
- Implantologie

- Інструменти для імплантології
- Implantologia
- زراعة الأسنان

IMPLANT

SURGICAL CHISELS

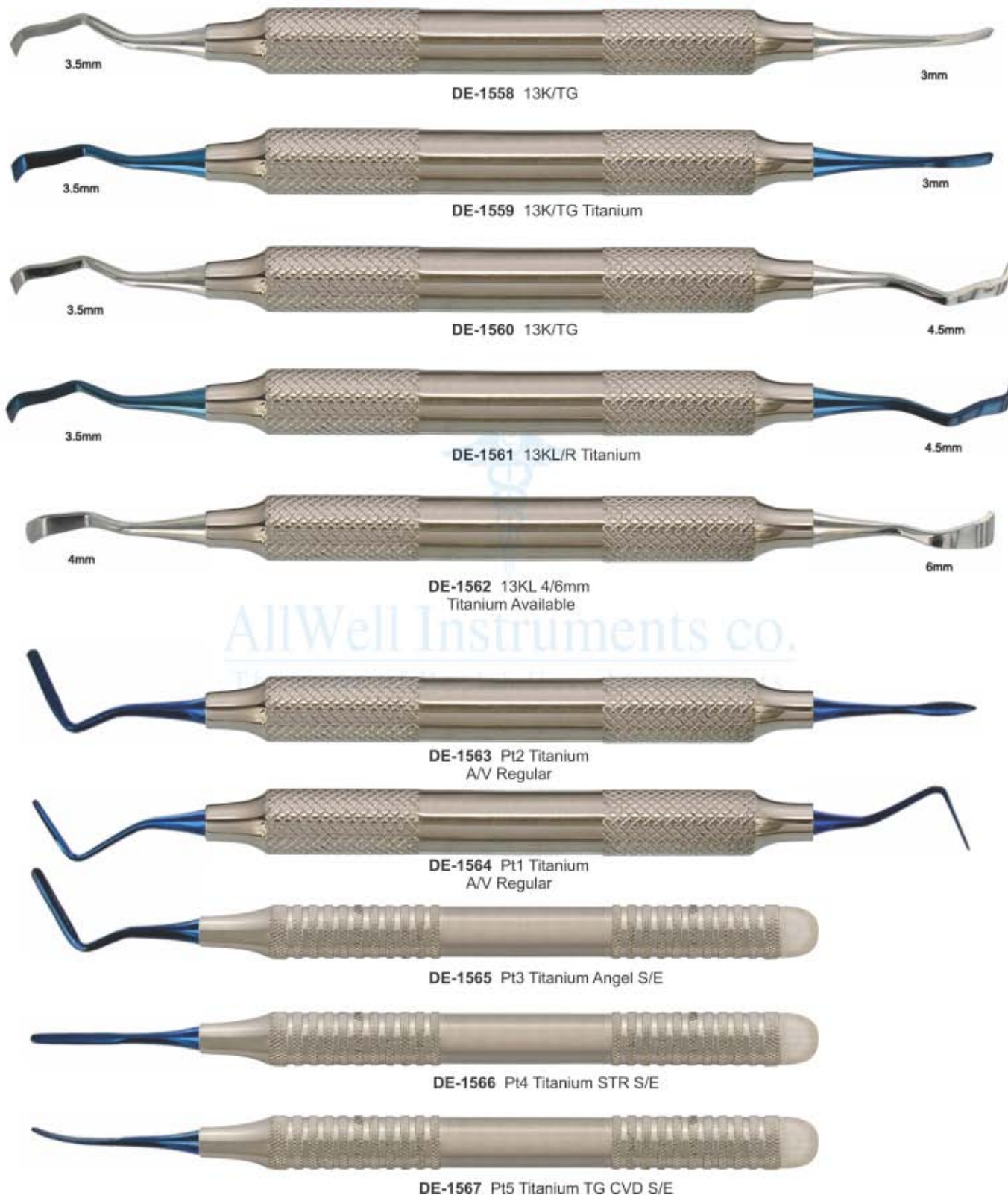



- Инструменты для имплантологии
- Implantologie
- Implantologie

- Інструменти для імплантології
- Implantologia
- زراعة الأسنان

MIXING SPATULA WITH SHOVEL



DE-1568
Bone Carrier
Titanium



DE-1569
Raspator, Prichard
Length 180 mm,
10 mm hollow handle,
double-ended
10.5 mm | 4.5 mm,



DE-1570
Raspator, Prichard
Length 180 mm,
10 mm hollow handle,
double ended



DE-1571
Raspator, Prichard
Length 180 mm,
10 mm hollow handle,
double-ended
10.5 mm | 4.5 mm,



DE-1572
Mixing Spatula
with shovel
17cm



DE-1573
Mixing Spatula
with shovel
18.5cm





- Инструменты для имплантологии
- Implantologie
- Implantologie
- Інструменти для імплантології
- Implantologia
- زراعة الأسنان

BONE GRAFTING INSTRUMENTS COMPACTOR /TAMPERS

Product offering includes instruments for harvesting, mixing and compacting bone Provides clinicians with the proper instrumentation for bone grafting procedures Weighted bone basin Prevents tipping and spilling of bone and other materials during mixing



DE-1574
Graft Packer,
Concave Tips
DE 4/6mm

DE-1575
Bone Spoon/
Packer DE 3mm

DE-1576
Graft Packer,
Serrated Tips
DE 6/8mm

DE-1577
Graft Packer,
Serrated Tips
DE 3/4mm

DE-1578
Graft Packer,
Smooth Tips
DE 5/8mm

DE-1579
Titanium graft packer/
placement site depth
gauge 3.3mm & 4.0mm
Diameter tips Marked
at 8, 11, 13, 15 & 18mm

DE-1580
Graft Material Spoon
Concave Tip For
Larger Grafts



- Инструменты для имплантологии
- Implantologie
- Implantologie

- Інструменти для імплантології
- Implantologia
- زراعة الأسنان

BONE GRAFTING INSTRUMENTS



DE-1581
Blade and pusher
Length 180 mm,
for straight or angled,
blade: 15 x 5 mm,
pusher: 4 mm diameter
Straight

DE-1582
Blade and pusher
Length 180 mm,
for straight or angled,
blade: 15 x 5 mm,
pusher: 4 mm diameter
angular

DE-1583
Spoon and pusher
Length 180 mm,
for angled spoon:
10 x 5 mm, pusher:
diameter 3 mm

DE-1584
Tunnelierungs
Instrument
length 175 mm,

DE-1585
Tunnelierungs
Instrument
length 175 mm,
different designs

DE-1586
Tamper
Length 170 mm,
for bone material,
double-ended,
diameter 3.2 mm
(2-4-6-8-10) and diameter
2.5mm (2-4-6-8-10)





- Инструменты для имплантологии
- Implantologie
- Implantologie
- Инструменти для імплантології
- Implantologia
- زراعة الأسنان

Pluggers Clarizio

Length 160 mm, with titanium tips for mixing and pouring of autologous, heterologous bone substitute material, diameter (3/4 or 6/8 mm)

BONE GRAFTING INSTRUMENTS



DE-1587 Ø 4mm
DE-1588 Ø 5mm
Compactor
150mm



DE-1589
Sinus Window
Bone Tampers
4 mm



DE-1590
Sinus Window
Bone Tampers
7 mm



DE-1591
6/8mm



DE-1592
3/4mm





- Инструменты для имплантологии
- Implantologie
- Implantsologie
- Инструменти для імплантології
- Implantologia
- زراعة الأسنان

SPOON AND PUSHER (TRINOVO)

Trinovo handle, different workers, for bone material, high-grade medical stainless steel, corrosion-resistant

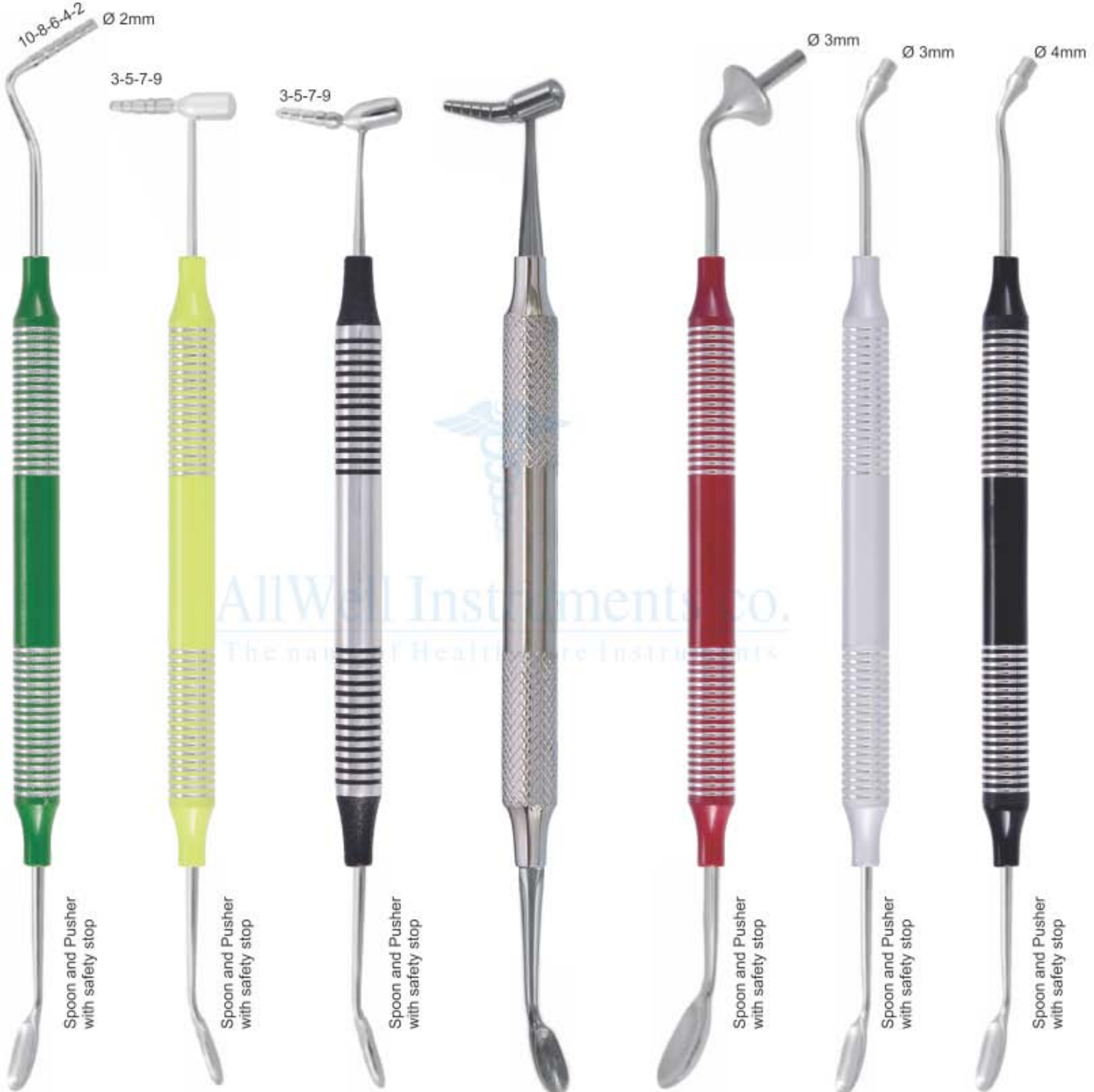
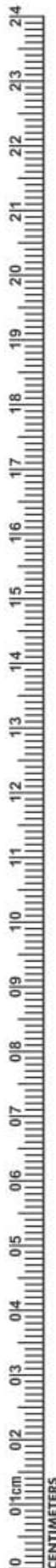

DE-1593
10x5mm

Spoon and Pusher
with safety stop

DE-1594
10x5mm

Spoon and Pusher
with safety stop

DE-1595
10x5mm

Spoon and Pusher
with safety stop

DE-1596
Bone Graft/Carrier
Titanium
2-4-6-8-10mm

DE-1597
15x10mm

Spoon and Pusher
with safety stop

DE-1598
10x5mm

Spoon and Pusher
with safety stop

DE-1599
10x5mm

Spoon and Pusher
with safety stop



- Инструменты для имплантологии
 - Implantologie
 - Implantologie
- Інструменти для імплантології
 - Implantoloia
 - زراعة الأسنان

PERIOSTEALS ELEVATOR 10mm Hollow Handle



DE-1600
Raspator,
BonexScraper
Length 165 mm,
10 mm hollow
handle,
double-ended 6
mm / 4 mm,

DE-1601
Raspator,
Raspatory
Length 180 mm,
10 mm hollow
handle,
double-ended
3 mm | 3 mm,

DE-1602
Raspator,
Raspatory
Length 180 mm,
10 mm hollow
handle,
double-ended
3 mm | 3 mm,

DE-1603
Raspator,
Papilla
Length 185 mm,
10 mm hollow
handle,
double-ended
3 mm | 2 mm,

DE-1604
Raspator,
bone scraper
Length 175 mm,
10 mm hollow
handle,
double-ended,

DE-1605
Raspator,
micro-Freer
Length 180 mm,
6 mm solid grip,
double-ended
3 mm | 4 mm

DE-1606
Raspator,
Freer
Length 180 mm,
6 mm solid
handle,
double-ended
5 mm | 5 mm,



- Инструменты для имплантологии
- Implantologie
- Implantologie

- Інструменти для імплантології
- Implantologia
- زراعة الأسنان

PERIOSTEALS ELEVATOR 10mm Hollow Handle

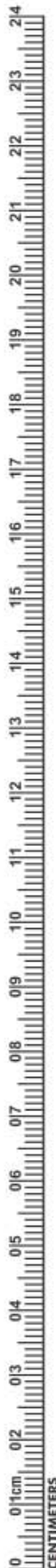

DE-1607
Raspator,
Freer
10 mm hollow
handle,
high-quality
medical
double ended



DE-1608
Raspator,
Molt
Length 180 mm,
8 mm solid
grip,
double-ended
6 mm



DE-1609
Raspator,
micro Freer
Length 185 mm,
10 mm hollow
handle,
double-ended,



DE-1610
Raspator,
micro Freer
Length 185 mm,
10 mm hollow
handle,
double-ended,



DE-1611
Raspator, micro
Raspator /
chisel
Length 170 mm,
10 mm hollow
handle,
double-ended,



DE-1612
Raspator, micro
Raspator /
chisel
Length 175 mm,
10 mm hollow
handle,
double-ended,



DE-1613
Raspator,
Micro Raspator /
chisel
Length 175 mm,
8 mm solid handle,
double-ended
3.5mm | 3.5 mm,



- Инструменты для имплантологии
- Implantologie
- Implantologie
- Інструменти для імплантології
- Implantoloia
- زراعة الأسنان

PERIOSTEALS ELEVATOR 10mm Hollow Handle



DE-1614
Raspatory Micro Molt
Length 175 mm,
corrosion-resistant

DE-1615
Raspatory Chipping
Workers:
Chisel 24G and 7.5 mm,
length about 175 mm,
corrosion-resistant

DE-1616
Raspatory MOLT
Work ends:
5.0 mm and 4.0 mm,
length about 175 mm,
corrosion-resistant

DE-1617
Rasp, Molt M9
Length 175 mm,
corrosion-resistant

DE-1618
Raspator, WAUTIER
Length 175 mm,
corrosion-resistant

DE-1619
Raspator, BENQUE
Length 170 mm,
workers
5 mm | 7 mm,
corrosion-resistant

DE-1620
Raspator, Nordberg
Length 180 mm,
8 mm hollow handle,
double-ended
6 mm | 4 mm



- Инструменты для имплантологии
- Implantologie
- Implantologie

- Інструменти для імплантології
- Implantologia
- زراعة الأسنان

Hollow Handle 10mm Length 170mm





- Инструменты для имплантологии
 - Implantologie
 - Implantologie
- Інструменти для імплантології
 - Implantoloia
 - زراعة الأسنان

TISSUE MEMBRANE FORCEPS



DE-1630
Tissue Graft Forcep
Serrated Teeth



DE-1631
Self Locking
Grooved



DE-1632
Tissue Graft Forcep
Serrated Teeth



DE-1633
Titanium
Locking Plier



DE-1634
TC Gripper Carbide
Tipped Tissue Forceps
Serrated Carbide Tips
14.5cm



DE-1635
Adson Carbide
Tipped Tissue Forceps
Serrated Carbide Tips
12cm



DE-1636
Micor Adson 1x2
Tissue Forcep 12.1cm
1x2 Teeth - 0.5mm Tips



DE-1637
Adson 7x7
Tissue Forceps
7x7 Teeth 12cm



DE-1638
Adson 7x7 Curved
Tissue Forceps
7x7 Teeth 12cm



DE-1639
Suture Pliers
Suture Forceps with
1.6mm Ring Tip



DE-1640
Debakey Atraumatic
Tissue Forceps Straight
Serrated Teeth
16cm



DE-1641
Debakey Atraumatic
Tissue Forceps Curved
Serrated Teeth
16cm





- Инструменты для имплантологии
- Implantologie
- Implantologie

- Инструменти для имплантології
- Implantologia
- زراعة الأسنان

TISSUE MEMBRANE FORCEPS



DE-1642
Russian Long
Tissue Forceps
Serrated Tip
20cm



DE-1643
Russian
Tissue Forceps
Serrated Tip
15cm



DE-1644
Tissue Punch Forceps
To Remove Tissue
After Using Punch



DE-1645
13.5 cm
narrow
Membrane tweezers KUEHNE



DE-1646
10.5 cm
Membrane tweezers KUEHNE



DE-1647
13.5 cm
wide
Membrane tweezers KUEHNE



DE-1648
Pin-Tweezers
with or without lock,
length 15 cm,
with lock



DE-1649
without lock,



DE-1650
Haltepinzette with lock
15,5 cm, for pins, towards
the tips, etc.,



DE-1651
Carry Forceps
15cm



DE-1652
Carry Forceps
15cm



DE-1653
Carry Forceps
15cm





- Инструменты для имплантологии
 - Implantologie
 - Implantologie
- Інструменти для імплантології
 - Implantoloia
 - زراعة الأسنان

OSTEOTOME CONVEXES / CONCAVE / CONIQUES

CONVEXES



DE-1654
SET OF 5 PIECES

CONCAVES



DE-1655
SET OF 5 PIECES

CONIQUES



DE-1656
SET OF 5 PIECES

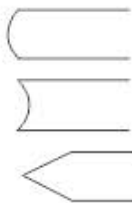
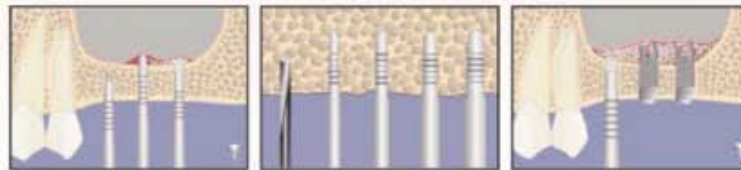

CONVEXES STRAIGHT	DE-1654	2,7 Ømm	3,2 Ømm	3,7 Ømm	4,2 Ømm	5 Ømm
CONCAVES STRAIGHT	DE-1655	2,7 Ømm	3,2 Ømm	3,7 Ømm	4,2 Ømm	5 Ømm
CONIQUES STRAIGHT	DE-1656	2,7 Ømm	3,2 Ømm	3,7 Ømm	4,2 Ømm	5 Ømm





- Инструменты для имплантологии
- Implantologie
- Implantologie
- Инструменти для имплантології
- Implantologia
- زراعة الأسنان

OSTEOTOME CONVEXES / CONCAVE / CONIQUES

CONVEXES



DE-1657
SET OF 5 PIECES

CONCAVES



DE-1658
SET OF 5 PIECES

CONIQUES



DE-1659
SET OF 5 PIECES

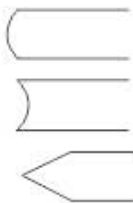
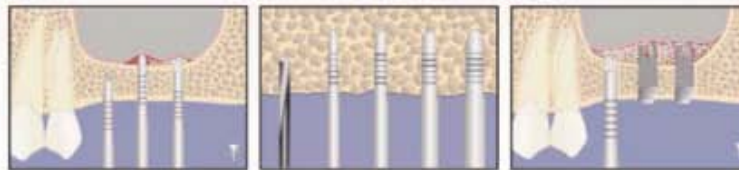

CONVEXES CURVED	DE-1657	2,7 Ømm	3,2 Ømm	3,7 Ømm	4,2 Ømm	5 Ømm
CONCAVES CURVED	DE-1658	2,7 Ømm	3,2 Ømm	3,7 Ømm	4,2 Ømm	5 Ømm
CONIQUES CURVED	DE-1659	2,7 Ømm	3,2 Ømm	3,7 Ømm	4,2 Ømm	5 Ømm





- Инструменты для имплантологии
- Implantologie
- Implantologie

- Інструменти для імплантології
- Implantologia
- زراعة الأسنان

TREPHINE

Burs with depth markings are suited for precise and simple transplantation of cylindrical bone grafts as well as for all other bone-extraction tasks.



- | | | | | | | | | |
|--|--|--|--|--|--|--|---|--|
| DE-1660
Ø Int. 2 mm
Ø Ext. 3 mm | DE-1661
Ø Int. 3 mm
Ø Ext. 3.5 mm | DE-1662
Ø Int. 4 mm
Ø Ext. 5 mm | DE-1663
Ø Int. 5 mm
Ø Ext. 6 mm | DE-1664
Ø Int. 6 mm
Ø Ext. 7 mm | DE-1665
Ø Int. 7 mm
Ø Ext. 8 mm | DE-1666
Ø Int. 8 mm
Ø Ext. 9 mm | DE-1667
Ø Int. 9 mm
Ø Ext. 10 mm | DE-1668
Ø Int. 10 mm
Ø Ext. 11 mm |
|--|--|--|--|--|--|--|---|--|

- Ø4.0 Ø5.0 Ø6.0 Ø7.0



DE-1669
Tissue Punch with pin
Set of Four Pieces



DE-1670
Tissue Punch
Set of Five Pieces



DE-1671
Tissue Punch
Set of Five Pieces



DE-1672
Trephine Drill
Set of Eight Pieces

AllWell Instruments co.
The name of Health Care Instruments



- Ø2.0mm Ø2.5mm Ø2.8mm Ø3.2mm Ø3.65mm Ø4.2mm Ø5.2mm

DE-1673
Short Implant Drills

DE-1674
Long Implant Drills



DE-1675
Trephine Drill
Set of Eight Pieces





- Инструменты для имплантологии
- Implantologie
- Implantologie

- Инструменти для имплантології
- Implantologia
- زراعة الأسنان

BONE SCRAPER STRAIGHT & CURVED



DE-1676
Bone Scraper
Straight

DE-1677
Bone Scraper
Curved

DE-1678
Tissue Punch
Straight

DE-1685
Tissue Punch
Curved

TISSUE PUNCH STRAIGHT & CURVED



AllWell Instruments co.
The name of Health Cure Instruments



DE-1692
Bone Mill

DE-1693
Basins For Bone



BONE CRUSHER
DE-1694





- Инструменты для имплантологии
 - Implantologie
 - Implantologie
- Інструменти для імплантології
 - Implantologia
 - زراعة الأسنان

KEYS FOR IMPLANT SCREW



DE-1695



DE-1696



DE-1697



DE-1698

TORQUE WRENCH & RATCHET



DE-1699 Star Torque Wrench 6.35mm Universal



DE-1700 Round Torque Wrench 4.0mm Universal



DE-1701 Hex Driver With 4.0mm Driver



DE-1702 Star Torque Wrench 6.35mm Universal



DE-1703 Hex Torque Wrench 4.0mm Universal



DE-1704 Star Torque Wrench 6.35mm Universal



DE-1705 Star Torque Wrench 6.35mm Universal



DE-1706 Star Torque Wrench 6.35mm Universal



DE-1707 Star Torque Wrench 6.35mm Universal



DE-1708 Star Torque Wrench 6.35mm Universal



DE-1709 Star Ratchet Wrench 6.35mm Universal



DE-1710 Star Ratchet Wrench 6.35mm Universal



DE-1711 Star Ratchet Wrench 6.35mm Universal



DE-1712 Star Ratchet Wrench 4.0mm Universal



DE-1713 Round Ratchet Wrench 4.0mm Universal



DE-1714 Round Ratchet Wrench 3.35mm Universal



DE-1715 Star Ratchet Wrench 4.0mm Universal



DE-1716 Star Ratchet Wrench 6.35mm Universal





- Инструменты для имплантологии
- Implantologie
- Implantologie
- Інструменти для імплантології
- Implantologia
- زراعة الأسنان

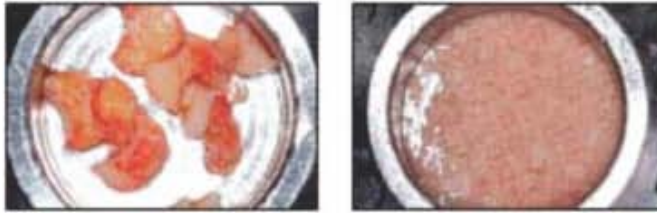

**DE-1717
BONE CRUSHER**
Titanium Metal Cutter

mallet



**DE-1718
BONE CRUSHER**
Titanium Metal Cutter

mallet



**DE-1719
BONE CRUSHER**



**DE-1720
BONE CRUSHER**
Bone Grinding Grain
1.5mm, 2mm, 2.5mm



**DE-1721
BONE CRUSHER**
Bone Grinding Grain
1.5mm, 2mm, 2.5mm



CENTIMETERS



- Инструменты для имплантологии
 - Implantologie
 - Implantologie
- Инструменти для імплантології
 - Implantologia
 - زراعة الأسنان

BONE EXPANDER SCREW & SURGICAL KITS



DE-1722
Bone Universal Kit
Drill: 2mm, 2.8mm, 3.2mm, 3.65mm, 4.2mm, 4.5mm, 4.8mm, 5.2mm
Trephines Bit:
3.0mm, 4.0mm, 5.0mm, 6.0mm, 7.0mm, 8.0mm, 9.0mm, 10mm.
Driver:
2.5mm, 2.5mm Hand Pcs
1.25mm, 1.25mm Hand Pcs
Short Driver 2.5mm
Long Driver 2.5mm
1.25mm, Short Hex Driver Hand Pcs
1.25mm, Long Hex Driver Hand Pcs
Torque Wrench 4.0mm



DE-1723
Bone Expander Kit
Expander: 2.6mm, 3.0mm, 3.4mm, 3.8mm, 4.3mm
Ratchet Driver
Parallel Pin
Pilot Drill
Drill 1.4mm
Drill Driver 4mm
Hand Driver 4mm
Ratchet 4.0mm



DE-1724
Bone Universal Kit
Drill: 2mm, 2.8mm, 3.2mm, 3.65mm, 4.2mm, 4.5mm, 4.8mm, 5.2mm
Trephines Bit:
3.0mm, 4.0mm, 5.0mm, 6.0mm, 7.0mm, 8.0mm, 9.0mm, 10mm.

Bone Compression:
2mm, 3.3mm, 2.8mm, 4.2mm, 3mm, 3.5mm
Driver:
2.5mm, 2.5mm Hand Pcs
1.25mm, 1.25mm Hand Pcs
Short Driver 2.5mm
Long Driver 2.5mm
1.25mm, Short Hex Driver Hand Pcs
1.25mm, Long Hex Driver Hand Pcs
Torque Wrench 6.35mm 1 Pcs



DE-1725
Conical Drills: 20 Pcs
Tissue Punches:
3.0mm, 3.50mm, 4.0mm, 4.5mm, 5.0mm, 6.0mm, 6.50mm
Bone Expander:
1.6/3.8mm, 1.9/3.0mm, 2.1/3.6mm, 2.6/3.8mm, 2.9/4.3mm
Drill Adapter: 1 Pcs
1.25mm, 2.50mm Hex Driver Hand Pcs

Pilot Drill: 1.6mm
Drill Bit: 1.4mm, 1.6mm, 1.8mm, 2.0mm, 2.2mm
Ratchet Driver: 4mm/6.35, 1.25/2.50
Rimer: 3.2/4.7mm, 3.7/4.7mm
Parallel Pin: 4.5mm, 2.5mm
Double step Drill: 2.4/2.8mm
Depth Gauge: 1 Pcs
Torque Wrench 6.35mm Universal: 1 Pcs





- Инструменты для имплантологии
- Implantologie
- Implantsologie
- Инструменти для имплантології
- Implantologia
- زراعة الأسنان

BONE INJECTORS, COLLECTORS & SUCTION TUBE



DE-1726
Ø 2,5mm / 3,5mm
170mm

DE-1727
Ø 4,5mm / 5,5mm
170mm

DE-1728
Ø 3,5mm / 4,5mm
170mm

DE-1729
Ø 6,0mm / 7,0mm
170mm



DE-1730
18cm
Straight / Bend
I.D 2.5mm
O.D 3.5

DE-1731
18cm
Straight / Bend
I.D 3.5mm
O.D 4.5

DE-1732
18cm
Straight / Bend
I.D 4.5mm
O.D 5.5

DE-1733
18cm
Straight / Bend
I.D 6.0mm
O.D 7.0



DE-1734
17.5cm

DE-1735
18cm

DE-1736
coarse
Ø 5mm

Suction tubes to collect the extracted bone material 180mm

DE-1737
fine
Ø 9mm



DE-1738
Suction Tubes
180mm

DE-1739
Suction Tubes
180mm

DE-1740
Suction Tubes
180mm



DE-1742
Ø 3 mm
length 180mm
DE-1743
Ø 4 mm
length 180mm
DE-1744
Ø 5 mm
length 180mm

DE-1741
Fig. 6FR
Frazier
15 cm - Ø 2 mm

IMPRESSION TRAYS



- Оттисные ложки
- Відбиткові ложки
- Porte-empreinte
- Cubetas para impresiones
- Abdrucklöffel
- صوتی الاتطباع

PERFORATED WITH RIM LOCK Set of 06 Pcs

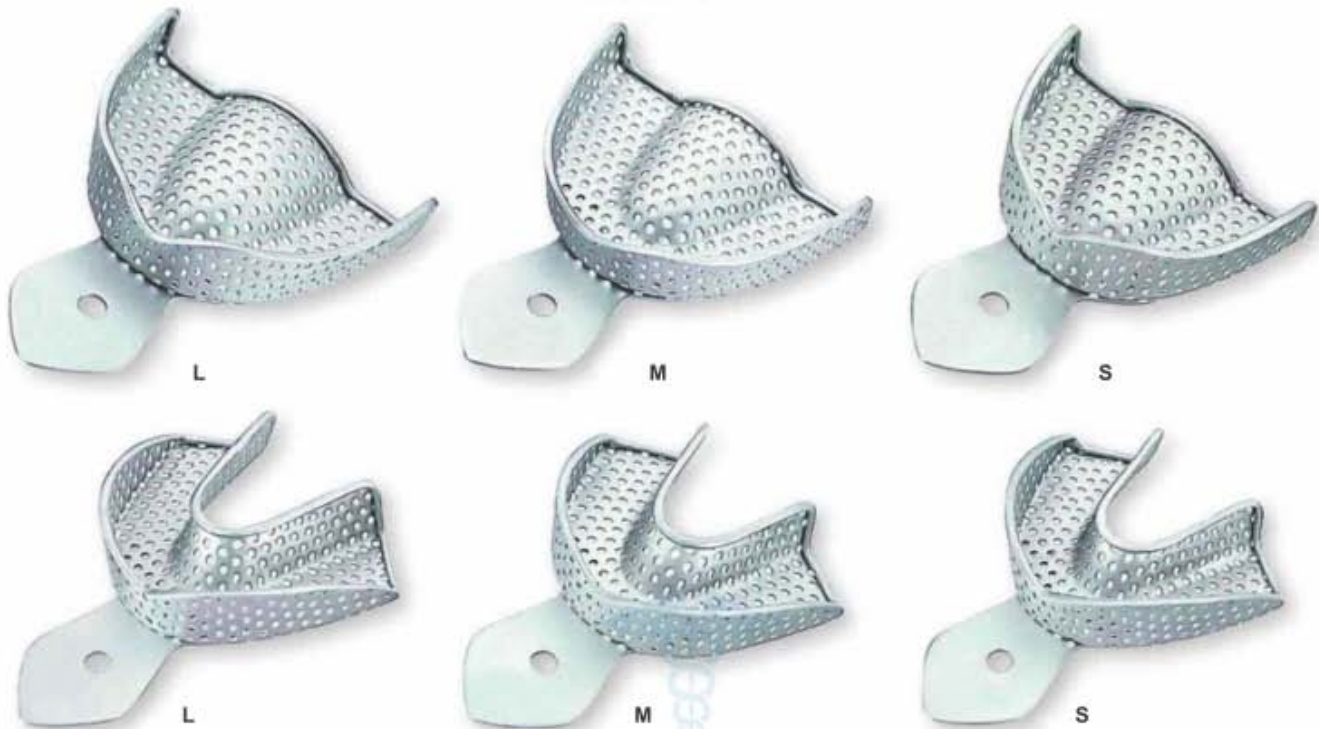

DE-1745 SET OF 06 PCS
Upper: S, M, L
Lower: S, M, L

PERFORATED WITH RIM LOCK Set of 8 Pcs



DE-1746 SET OF 08 PCS
Upper: XS, S, M, L
Lower: XS, S, M, L

DE-1747 SET OF 08 PCS
Upper: S, M, L, XL
Lower: S, M, L, XL

DE-1748 SET OF 10 PCS
Upper: XS, S, M, L, XL
Lower: XS, S, M, L, XL





- Оттисные ложки
- Porte-empreinte
- Abdrucklöffel
- Відбиткові ложки
- Cubetas para impresiones
- صواني الانطباع

SOLID WITH RIM LOCK
Set of 6 Pcs



L



M



S



L



M



S

DE-1749 SET OF 06 PCS
Upper: S, M, L
Lower: S, M, L

SOLID WITH RIM LOCK
Set of 8 Pcs



L



M



S



XS



L



M



S



XS

DE-1750 SET OF 08 PCS
Upper: XS, S, M, L
Lower: XS, S, M, L

DE-1751 SET OF 08 PCS
Upper: S, M, L, XL
Lower: S, M, L, XL

DE-1752 SET OF 10 PCS
Upper: XS, S, M, L, XL
Lower: XS, S, M, L, XL



IMPRESSION TRAYS



- Оттисные ложки
- Porte-empreinte
- Abdrucklöffel
- Відбиткові ложки
- Cubetas para impresiones
- صوتی الاطباع

PERFORATED FULL DENTURE Set of 8 Pcs

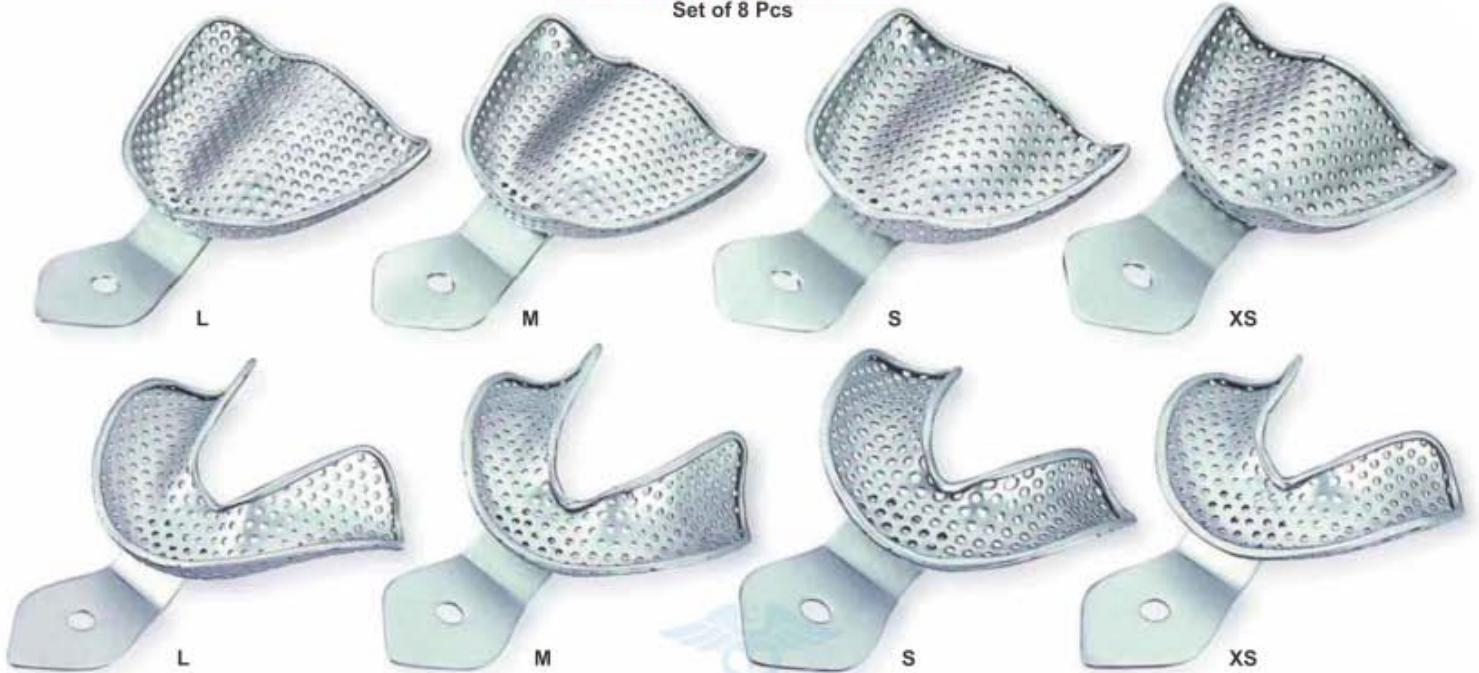

DE-1753 SET OF 08 PCS
Upper: S, M, L, XL
Lower: S, M, L, XL

DE-1754 SET OF 08 PCS
Upper: S, M, L
Lower: S, M, L

SOLID FULL DENTURE Set of 8 Pcs



DE-1755 SET OF 08 PCS
Upper: S, M, L, XL
Lower: S, M, L, XL

DE-1756 SET OF 06 PCS
Upper: S, M, L
Lower: S, M, L





- Оттисные ложки
 - Porte-empreinte
 - Abdrucklöffel
- Відбиткові ложки
 - Cubetas para impresiones
 - صواني الانطباع

Perforated Without Rim Lock

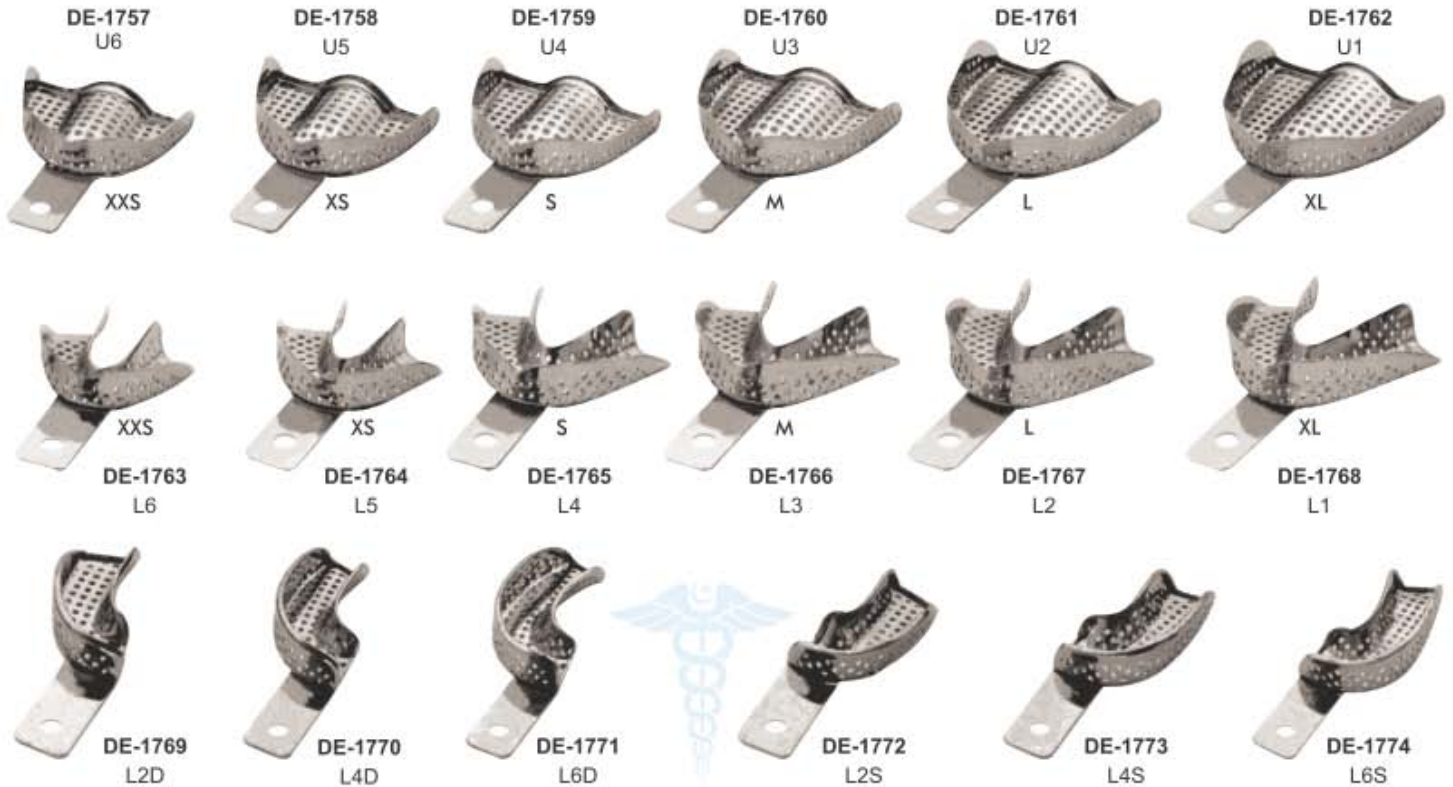

Solid With Rim Lock

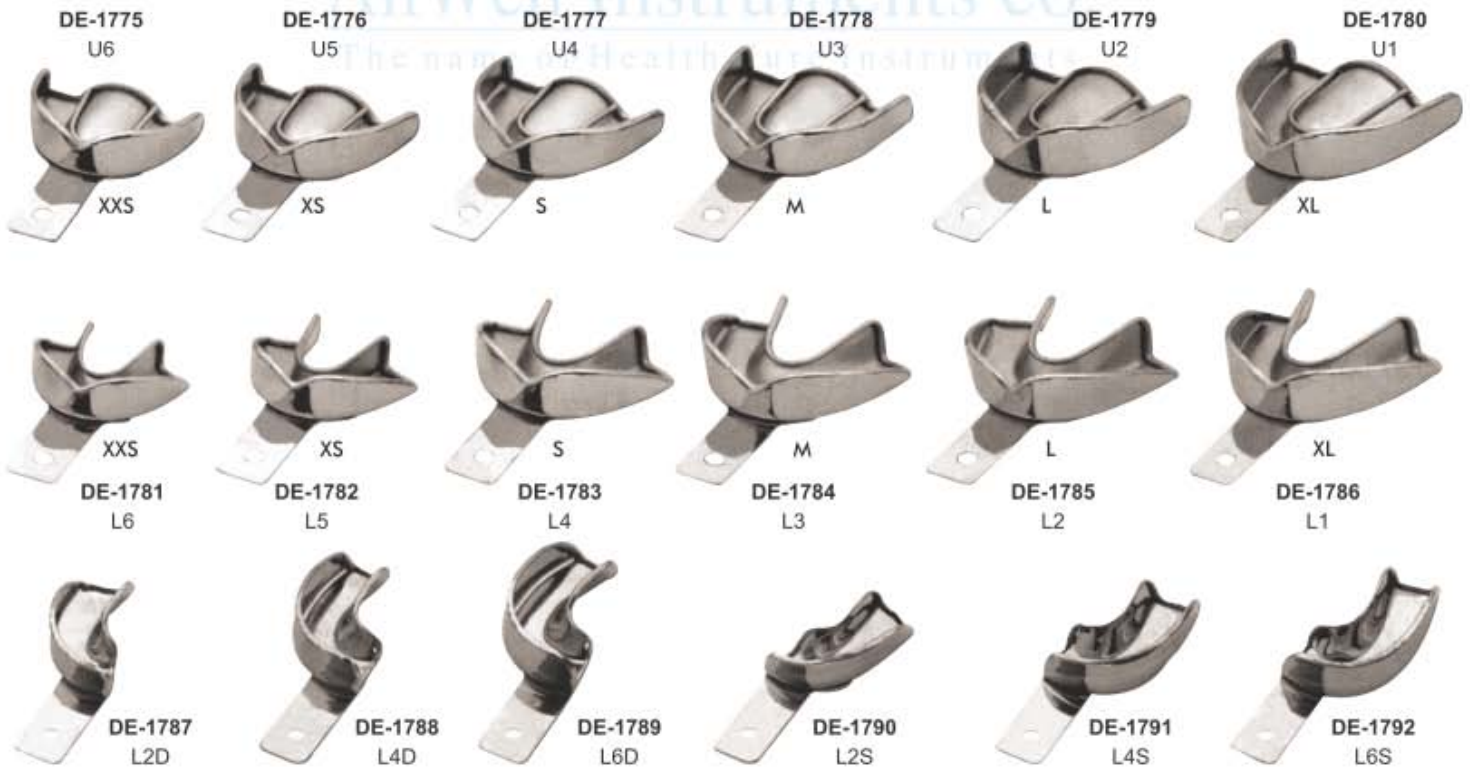



DE-1793
Instruments Cassettes
5 Pieces, 7 Pieces, 10 Pieces & 20 Pieces



DE-1794
Instruments Cassettes
5 Pieces, 7 Pieces, 10 Pieces & 20 Pieces

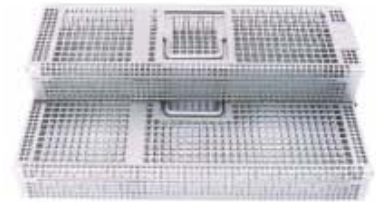

DE-1795
Instruments Cassette
7 Pieces & 10 Pieces



DE-1796
Gracey Curette Set Cassettes



DE-1797
182 x 150 x 20 mm
10 Instruments



DE-1798
180 x 85 x 15 mm
5 Instruments



DE-1799
288 x 182 x 35 mm
20 Instruments



DE-1800
288 x 182 x 35 mm
20 Instruments



DE-1801
182 x 145 x 35 mm
10 Instruments



DE-1802
182 x 72 x 35 mm
5 Instruments



DE-1803
182 x 145 x 35 mm
9 Instruments



DE-1804
Gracey Curette Set Stand



DE-1805
Sinus Lift Set Stand





Made of 18/8 stainless steel



KIDNEY TRAY WITH COVER
(English Pattern)

	Size
DE-1806	150 mm
DE-1807	200 mm
DE-1808	240 mm
DE-1809	300 mm



Kidney Trays

	With lid available	Without lid available
DE-1810	6"	DE-1814 6"
DE-1811	8"	DE-1815 8"
DE-1812	10"	DE-1816 10"
DE-1813	12"	DE-1817 12"



Deep	
DE-1818	2.25" - 2"
DE-1819	4.75" - 2"
DE-1820	5.5" - 2.5"
DE-1821	6.25" - 2.75"
DE-1822	7" - 3.5"



Sterilizing Drum

Art #	Ø mm	h mm
DE-1823	80	80
DE-1824	120	120
DE-1825	160	120
DE-1826	190	140
DE-1827	190	200
DE-1828	240	120
DE-1829	240	160
DE-1830	240	240
DE-1831	290	120
DE-1832	290	160
DE-1833	290	240
DE-1834	340	160
DE-1835	340	240
DE-1836	390	145
DE-1837	390	200
DE-1838	390	290



Cotton Holder - DE-1839



Spirit Lamp DE-1840



DE-1841 Endodontic Box



Forcep Jar	
DE-1842	25 x 80mm
DE-1843	30 x 100mm
DE-1844	100 x 200mm
DE-1845	75 x 173mm



DE-1846 6" x 8"
DE-1847 8" x 10"
DE-1848 10" x 12"
Without Lid



DE-1849 Instruments Box



SCALER TRAY DE-1850
100 x 200 mm





DESCRIPTION	PAGE #	DESCRIPTION	PAGE #	DESCRIPTION	PAGE #
3 PRONG CLASP ADJUSTABLE PLIER TC	107	CARVERS FILLING INSTRUMENTS	89	FLAT NOSE PLIER WITH SERRATION	105
ACORN FILLING INSTRUMENTS	52	CARVERS INSTRUMENTS	73	FLOOR ROOT ELEVATORS	100
ADAM PLIER WITH TC	102	CARVERS	71	FLUCH-CUT DISTAL AND CUTTING PLIERS	100
ADAMS PLIER ROUND BOX	100	CASTROVIEJO NEEDLE HOLDERS	86	FOERSTER DRESSING FORCEPS	148
ADAMS PLIERS FOR BENDING WIRE	100	CASTROVIEJO SCISSORS	84	FORCEP JAR	148
ADAMS SMALL WIRE BENDING AND LOOP FORMING PLIERS	99	CEMENT SPATULAS	75	FREEDMAN "DUCKHEAD" IMPLANTOLOGY INSTRUMENTS	112
ADERER FACEBOW LOOP FORMING PLIERS	101	CHEEK RETRACTOR LONG	80	FREEDMAN BURNISHERS IMPLANTOLOGY INSTRUMENTS	112
ADERER LARGE WIRE BENDING AND LOOP FORMING PLIERS	100	CHEEK RETRACTOR	78	FREER PERIOSTEAL ELEVATORS	95
ADERER PLIER	101	CHEEK RETRACTORS, MINNESOTA	80	FRIEDMAN BONE ROUNGER	14
ADSON BROWN TWEEZERS	32	CHEEK RETRACTORS, RETRACTOR IVORY	80	FRIEDMAN ROOTS ELEVATOR	21
ADSON CARBIDE TIPPED TISSUE FORCEPS	133	CHEEK RETRACTORS, TONGUE DEPRESSORS	80	GAUGE FOR MEASURING	109
ADSON NEEDLE HOLDERS	86	CHISELS HOES FILLING INSTRUMENTS	74	GERALD TWEEZERS	31
ADSON TWEEZERS	32	CLAMP OSTEOMETER	109	GILLIES TWEEZERS	31
ADSON-TC TWEEZERS	32	CLAPPISON/FRAMHAM RESTORATIVE INSTRUMENTS	70	GILLIES NEEDLE HOLDER WITH SCISSORS	36
ALLEN PERIOSTEAL ELEVATORS	95	CLAW-LIFT ROOTS ELEVATOR	22	GOLDMAN FOX EXPLORERS	36
ALLIS 4.5 HAEMOSTATIC FORCEPS	87	COHEN UNIVERSAL FORCEPS	10-11	GOLDMAN FOX MERRITT B EXPLORERS	36
ALLIS-BABY 3.4 HAEMOSTATIC FORCEPS	87	COLLEGE CURVED	32	GOLDMAN FOX UNIVERSITY OF MICHIGAN EXPLORERS	36
AMALGAM CARVERS	56-57, 70-71	COLLEGE TWEEZER	32	GOLDMAN FOX WILLIAMS EXPLORERS	36
AMALGAM FILES	71	COLLEGE WITH LOCK TWEEZERS	31	GOLDMAN PERIODONTAL INSTRUMENTS	58
AMALGAM INSTRUMENTS & SCALPEL HANDLES	92	COLLINS TONGUE FORCEPS	31	GOLDMAN-FOX PERIOSTEAL ELEVATORS	95
AMALGAM INSTRUMENTS	93	COMPOSITE/PLASTIC FILLING INSTRUMENTS	49-50, 54	GOLDMAN-FOX SCISSORS	83-84
AMALGAM WELL MATRIX RETAINERS	91	CONDENSER INSTRUMENTS	118	GOLDMAN-FOX SET	61
AMALGAM WELL	93	CONDENSER MORTONSON FILLING INSTRUMENTS	50	GOLDSTEIN INTERPROXIMAL EXCAVATOR	67
ANATOMICAL CARVER	71	CONTOURING INSTRUMENT IMPLANTOLOGY INSTRUMENTS	111	GRACEY AFTER FIVE	42
ANDREW RESTORATIVE INSTRUMENTS	70	CONTOURING PLIER	101	GRACEY CURETTE INSTRUMENTS	62
ANGLE FORMERS	72	COSMETIC CONTOURING	113	GRACEY CURETTE SET CASSETTES	147
ANGLED DIRECT BOND BRACKET REMOVER TC	106	COTTON HOLDER	148	GRACEY CURETTE	43
ANISWORTH CLAMPS FORCEPS	88	COUPLAND ROOT ELEVATORS	17	GRACEY MINI FIVE	42
ANTERIOR FILLING INSTRUMENTS	68	COUPLAND ROOT ELEVATORS	18	GRACEY PERIODONTAL INSTRUMENTS	39
ANTERIOR	47	CRANE KAPLAN TWEEZERS	32	GRACEY SET OF 7 PCS	40-41
APEXO ROOT ELEVATORS	15-19	CRANE-KAPLAN PERIODONTAL INSTRUMENTS	59	GRAFT PACKER, CONCAVE TIPS	125
APICAL ROOT ELEVATORS	19	CRILE NEEDLE HOLDERS	85	GREGG IMPLANTOLOGY INSTRUMENTS	111
ARCH FORMING PLIERS	104	CRILE-WOOD NEEDLE HOLDERS	85-86	GRITMAN CEMENT SPATULAS	75
ARTICULATORS	77	CROWN AND BAND CONTOURING PLIERS	105	GROSS MAIER DRESSING FORCEPS	147
A-TRAUMATIC EXTRACTION SET	03	CROWN REMOVER	90	GUM SCISSORS	87
ATRAUMATIC TWEEZERS	31	CROWN SPREADERS	90	HAEMOSTATIC FORCEPS & TOWEL CLAMPS	87
BACK ACTION FILLING INSTRUMENTS	52	CRAYER EXTRACTING FORCEPS	10	HALSEY NEEDLE HOLDERS	85-86
BACKHAUS HAEMOSTATIC FORCEPS	87	CRAYER ROOTS ELEVATOR	23	HALSTEAD MOSQUITO HAEMOSTATIC FORCEPS	87
BACCLITE HANDLE WAX KNIVES	76	CURETTE COLUMBIA	43	HALSTEAD MOSQUITO NEEDLE HOLDERS	86
BALDWIN FILLING INSTRUMENTS	49	CURETTE INSTRUMENTS	43	HALTEPINZETTE WITH LOCK	134
BALL FILLING INSTRUMENTS	52	CURETTE MCCALL	43	HAMMER HEAD TIE BACK PLIER	104
BALL HOOK CRIMPING PLIER	105	CURETTE	40	HANDLES FOR MOUTH MIRRORS	30
BAND PUSHER	99	CURETTERS SET OF 8 PIECES	43	HARD WIRE CUTTERS	107
BAND REMOVING PLIER	90	CURETTES	40-43, 61-62	HARRIS EXTRACTING FORCEPS	11
BAND SEATER AUTO CLEAVABLE	97	CUTTING INS PERIODONTAL INSTRUMENTS	39	HARTMAN (BABY MOSQUITO) NEEDLE HOLDERS	86
BAND SEATING PLIER	94	DARBY-PERRY EXCAVATORS	85	HATCHETS FILLING INSTRUMENTS	46
BANDS & CROWNS PLIER	101	DE LA ROSA PLIERS WITH GROOVED	105	HEAT CARRIERS	46
BASINS FOR BONE	138	DE LA ROSA PLIERS	105	HEBER ROOTS ELEVATOR	24
BAUMGARTER NEEDLE HOLDERS	85	DEAN SCISSORS	84	HEIDBRINK ROOT ELEVATORS	20-21, 26
BAUMGARTNER NEEDLE HOLDERS	86	DEBAKEY ATRAUMATIC TISSUE FORCEPS	133	HEIDMANN PERIODONTAL INSTRUMENTS	39
BAYONET ROOTS ELEVATOR SET	21	DEEP BOWL	148	HEMINGWAY CURETTE INSTRUMENTS	63
BEAUFORT FILLING INSTRUMENTS	52	DEEP ROOT PICK FORCEPS (APICAL SET OF 9)	04	HEMINGWAY TWEEZERS	32
BEEBEE NEEDLE HOLDERS	85	DELICATE NEEDLE HOLDERS	85	HOES	71
BEIN ROOT ELEVATORS	15-16, 24	DELUXE BRACKET HOLDER TWEEZERS	96	HOLLANBACK PERIODONTAL INSTRUMENTS	39
BEYER BONE ROUNGER	14	DEN-HARD CHEEK RETRACTORS	79	HOLLANBACK FILLING INSTRUMENTS	50
BINANGLE FILLING INSTRUMENTS	74	DENTAL MIRROR PERIODONTAL INSTRUMENTS	39	HOLLANBACK IMPLANTOLOGY INSTRUMENTS	114
BIRD BEAK ANGLED BENDING PLIER	103	DENTAL SYRINGES	13	HOLLANBACK RESTORATIVE INSTRUMENTS	70
BIRD BEAK PLIER WITH TC	102	DERF NEEDLE HOLDERS	85	HOLLOW HANDLE	132
BIRD BEAK WIRE BENDING & CUTTING PLIERS	101	DERF NEEDLE HOLDERS	86	HOLLOW WARE	148
BIRD BEAK WIRE BENDING PLIER	100	DIRECT BOND BRACKET HOLDER TWEEZERS	96	HOLLOWCHOP CONTOURING PLIERS	106
BIRD BEAK WITH CUTTER PLIERS	104	DIRECT BONDING BRACKET HOLDERS	96	HOOK CRIMPING PLIER ANGLED STRAIGHT TC	107
BLACK FILLING INSTRUMENTS	50	DIRECT BONDING BRACKET REMOVER PLIER TC	106	HOOK KNIVES	76
BLACK TITANIUM COLOUR COATED INSTRUMENTS	110-111	DIRECT BRACKET REMOVER TC	107	HOW PLIER CURVED WITH TC	103
BLADE AND PUSHER	126	DISCOID-CLEOID CARVER	71	HOW PLIER CURVED	99, 104
BLUMENTHAL BONE ROUNGER	14	DISTAL END CUTTER REGULAR WITH TC	102	HOW PLIER STRAIGHT WITH TC	103
BOGHOSIAN FILLING INSTRUMENTS	49	DISTAL END CUTTER, SAFETY HOLD PLIER	102	HOW PLIER STRAIGHT	103
BOGHOSIAN IMPLANTOLOGY INSTRUMENTS	111	(IDEAL FOR CUTTING WIRE) TC	107	HOWARD PERIOSTEAL ELEVATORS	95
BOLEY GAUGE	109	DISTAL END, WIRE CUTTERS & BRACKET REMOVER PLIERS	107	HYGIENIST PERIODONTAL INSTRUMENTS	58
BONE BRACKET GAUGE	96	DOUBLE ENDED CEMENT SPATULA	98	HYGIENIST-JACQUETTE PERIODONTAL INSTRUMENTS	58
BONE CARRIER TITANIUM	124	DRESSING TWEEZERS	31-32	HYGIENIST-TOWNER PERIODONTAL INSTRUMENTS	58
BONE CRUSHER	138, 140	ELASTIC SEPARATING PLIER	107	HYLIN CEMENT SPATULAS	75
BONE EXPANDER SCREW & SURGICAL KITS	141	ELASTOMERIC LIGATURE PLACING FORCEPS	107	HYLIN ROOTS ELEVATOR	23
BONE FILES	94	WITH GROOVE FALCON	107	IMPLANT GAGES	108
BONE GRAFT/CARRIER TITANIUM	128	ELLIOT MATRIX RETAINERS	91	IMPLANT SINUS LIFT INSTRUMENTS	117, 122
BONE GRAFTING INSTRUMENTS COMPACTOR /TAMPERS	125	ENDED CHEEK RETRACTORS	79	IMPLANT	123
BONE GRAFTING INSTRUMENTS	126-127	ENDODONTIC BOX	148	IMPLANTOLOGY IMPLANTOLOGY INSTRUMENTS	112
BONE INJECTORS, COLLECTORS & SUCTION TUBE	142	ENDODONTICS INSTRUMENTS	47	IMPLANTOLOGY INSTRUMENTS	111
BONE MILL	138	ENGLISH PATTERN KLEIN #3 PEDODONTIC UNIVERSAL FORCEPS	08	IMPLANTOLOGY	108-110
BONE ROUNGER	14	EXAMINATION KIT SET OF 3 PIECES	34	IMPRESSION TRAYS	143-146
BONE SCRAPER STRAIGHT & CURVED	138	EXAMINATION SET OF 4 PIECES	34	INSTRUMENTS BOX	148
BONE SPOON/ PACKER	125	EXAVATORS	37	INSTRUMENTS CASSETTES & STANDS	147
BONE THICKNESS GAUGE	109	EXCAVATOR PERIODONTAL INSTRUMENTS	39	INTERPROXIMAL CARVER IMPLANTOLOGY INSTRUMENTS	111
BONE UNIVERSAL KIT	141	EXCAVATORS INSTRUMENTS SET OF 11 PIECES	57	INTERPROXIMAL OFF-ANGLE FILLING INSTRUMENTS	49
BRACKET REMOVER ANGULATED PLIER	103	EXCAVATORS INSTRUMENTS	64-67	INTRALIGAMENTAL ANESTHESIA SYRINGE	13
BRACKET REMOVER PLIER STRAIGHT	103	EXCAVATORS	64	IRIS SCISSORS	83-84
BRACKET REMOVER PLIERS ANGLED WITH TC	102	EXPLORER PERIODONTAL INSTRUMENTS	39	IVORY LIGHT WEIGHT CLAMPS FORCEPS	88
BRACKET REMOVER PLIERS STRAIGHT WITH TC	102	EXPLORERS INSTRUMENTS	35	IVORY MATRIX RETAINERS	91
BRACKET REMOVING PLIER ROUND BOX	99	EXPLORERS	33-45	IWANSON SPRING CALIPER	109
BRACKET REMOVING PLIER	99	EXTRACTING FORCEPS (AMERICAN PATTERN)	10-14	JACQUETTE SCALERS PERIODONTAL INSTRUMENTS	59
BREWER CLAMPS FORCEPS	88	EXTRACTING FORCEPS (ENGLISH PATTERN)	01-02, 05-07	JARA BEAK PLIER	104
BURNISHER FILLING INSTRUMENTS	49	EXTRA-FLEX IMPLANTOLOGY INSTRUMENTS	114	JENNINGS CHEEK RETRACTORS	79
BURNISHER FILLING INSTRUMENTS	54	FALCON BEAK CONTOURING PLIERS	100	JOHNSON CONTOURING PLIERS	100
BURNISHER UNIVERSITY OF MICHIGAN AMALGAM CARVERS	56	FARABEU RETRACTOR	82	JONES HAEMOSTATIC FORCEPS	87
BURNISHERS FILLING INSTRUMENTS	52-53	FELDMAN RETRACTOR	82	JOSEPH SCISSORS	84
BURNISHERS IMPLANTOLOGY INSTRUMENTS	112	FILES FILLING INSTRUMENTS	53	KELLY HAEMOSTATIC FORCEPS	87
BUSER PERIOSTEAL ELEVATORS	95	FILLING INS PERIODONTAL INSTRUMENTS	39	KELLY SCISSORS	83-84
CARRY FORCEPS	134	FILLING INSTRUMENTS	37, 44, 49-55, 69, 72	KELLY-RANKIN HAEMOSTATIC FORCEPS	87
CARVER HOLLANBACK AMALGAM CARVERS	56	FLAT NOSE PLIER SMOOTH	105	KEYS FOR IMPLANT SCREW	139



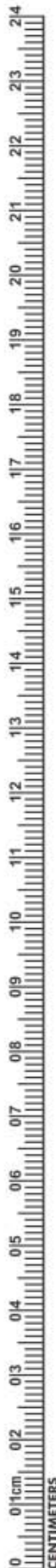

DESCRIPTION	PAGE #	DESCRIPTION	PAGE #	DESCRIPTION	PAGE #
KIDNEY TRAY WITH COVER (ENGLISH PATTERN)	148	ORTHO LIGHT SCALER HEAVY	97	SINUS LIFT INSTRUMENT	118-121
KIDNEY TRAYS	148	ORTHO LIGHT SCALER SINGLE ENDED	98	SINUS LIFT SET STAND	147
KILNER (RAGNELL) SCISSORS	84	ORTHO LIGHT SCALER	97	SINUS WINDOW BONE TAMPERS	127
KLEINERT-KUTZ BONE ROUNDER	14	ORTHODONTIC INSTRUMENTS	96-98	SINUSLIFT INSTRUMENTS	118
KOPP ROOTS ELEVATOR	23-24	ORTHOLITE LIGATURE DIRECTOR SCALER	98	SIOVELAND RETAINERS TOFFLEMIRE-JUNIER MATRIX RETAINERS	91
KRARNER-NEVINS BONE CHISEL	94	OSTEOMETER MEASURING FORCEPS	96	SMAHA ELASTOMERIC LIGATURE PLACING FORCEPS	107
LA GRANGE SCISSORS	83-84	OSTEOTOME CONVEXES / CONCAVE / CONIQUES	135-136	SPENCER SCISSORS	84
LADMORE FILLING INSTRUMENTS	52	OVAL SPOONS/DARBY-PERRY	65	SPIRIT LAMP	148
LADMORE IMPLANTOLOGY INSTRUMENTS	112	P.K. THOMAS WAXING INSTRUMENTS	73	SPOON AND PUSHER (TRINOVO)	128
LAP-JOINT THREE PRONG PLIER	106	PALATAL ARCH PLIER	105	SPOON AND PUSHER WITH SAFETY STOP	128
LAX/JUTOR ROOT ELEVATORS	19	PALMER CLAMPS FORCEPZ	88	SPOONS	64
LE CRON CEMENT SPATULAS	75	PDL ELEVATORS	28-29	SPREADERS	46
LESSMANN	76	PEDIATRIC TOOTH EXTRACTING FORCEPS SET	09	STANDARD LIGATURE CUTTER TC	106
LIGATURE FORMING PLIERS	101	PERIODONTAL FILLING INSTRUMENTS	53	STEP PLIERS WITH TC	103
LIGHT WIRE BIRD BEAK LONG PLIER WITH TC	102	PERIODONTAL INSTRUMENTS	37, 39, 58, 60, 95	STERILIZING DRUM	148
LIGHT WIRE BIRD BEAK LONG PLIER	104	PERIODONTAL PROBES	46, 48	STOP V BENDING PLIER	105
LIGHT WIRE BIRD BEAK PLIERS	104	PERIOSTEALS ELEVATOR	95, 129-130	STRAIGHT DIRECT BOND BRACKET REMOVER TC	107
LIGHT WIRE CUTTER MICRO WITH TC	102	PERIOTOME ROOTS ELEVATOR	26	SURGICAL CHISELS	123
LIGHT WIRE PLIER	104	PERRY TWEEZER	31-32	SURGICAL TWEEZERS	31
LINDO LEVIAN ROOT ELEVATORS	20	PESTERIOR BEND REMOVER PLIER LONG	103	SUTURE PLIERS SUTURE FORCEPS	133
LINGUAL / PALATAL ARCH FORMING PLIERS	101	PESTERIOR BEND REMOVER PLIER MEDIUM	103	SYNDESMOTOMES ROOTS ELEVATOR	26
LINGUAL PLIER LONG HANDLE	106	PESTERIOR BEND REMOVER PLIER SHORT	103	TAMPER	126
LINGUAL PLIER WEINGART	106	PIN & LIGATURE CUTTERS TC	106	TANNER FILLING INSTRUMENTS	52, 69
LINGUAL WEINGART PLIER	106	PIN HOLDING PLIER TC	107	TANNER IMPLANTOLOGY INSTRUMENTS	114
LINING APPLICATOR DOUBLE END	55	PIN-TWEEZERS	134	TC GRIPPER CARBIDE	133
LOCKLIN SCISSORS	84	PLAIN MIRRORS	30	THARP RESTORATIVE INSTRUMENTS	70
LONDON COLLEGE TWEEZERS	31	PLASTER KNIFE 76 SPECIAL INOX	76	THREE PRONG PLIERS REGULAR	106
LORNA HAEMOSTATIC FORCEPS	87	PLIERS FOR ORTHODONTICS & PROSTHETICS	99-106	TISSUE GRAFT FORCEP SERRATED TEETH	133
LUCAS	132	PLUGGER PERIODONTAL INSTRUMENTS	39	TISSUE MEMBRANE FORCEPS	132, 134
LUER BONE ROUNDER	14	PLUGGER BLACK AMALGAM CARVERS	56	TISSUE PUNCH FORCEPS	134
LUKS	47	PLUGGERS	45, 48	TISSUE PUNCH STRAIGHT & CURVED	136
LUXATOR ROOT ELEVATORS	15-16, 21	PLUGGERS/CONDENSERS FILLING INSTRUMENTS	50	TOFFLEMIRE-SENIOR MATRIX RETAINERS	91
LUXIER ROOTS ELEVATOR	22	PLUGGERS/CONDENSERS	51	TOFFLEMIRE-UNIVERSAL MATRIX RETAINERS	91
MAGNIFYING MIRRORS	30	POINTED CURETTE	60	TORQUE WRENCH & RATCHET	139
MANUAL CROWN REMOVER	90	POINTED PROBES SINGLE ENDED	36	TOWNER PERIODONTAL INSTRUMENTS	58
MARCOTTE LOOPING PLIER	105	POSTERIOR	48	TOWNER-JACQUETTE PERIODONTAL INSTRUMENTS	58
MARGIN TRIMMERS	72	POSTERIOR BAND REMOVER PLIERS	102	TREPHINE DRILL SET OF EIGHT PIECES	137
MARGINAL RIDGE & EMBRASURE SHAPING INSTRUMENT	113	POTT ROOTS ELEVATOR	25	TUFTS FILLING INSTRUMENTS	49
MARKLEY PLUGGERS/CONDENSERS	51	POWER CROWN REMOVER LIFT	90	TUNNELIERUNGS INSTRUMENT	126
MARQUETTE FILLING INSTRUMENTS	50	PRICHARD PERIOSTEAL ELEVATORS	95	TWEED / ANGEL FORMING AND TORQUING PLIERS	101
MARYAM TWEEZERS	32	PROBES DOUBLE ENDED	35	TWEED / ANGLE RECTANGULAR ARCH FORMING & TORQUING PLIERS	100
MATHIEU NEEDLE HOLDERS	86	PROBES SINGLE ENDED	34	TWEED ARCH FORMING PLIER TC	102
MATRIX RETAINERS	91	QUETIN FILLING INSTRUMENTS	49	TWEED CUTTER PLIER	104
MAYO NEEDLE HOLDERS	85	RASPATOR, BENQUE	131	TWEED LOOP FORMIN PLIERS	100
MAYO SCISSORS	83	RASPATOR, FREER	129, 131	TWEED LOOP FORMING PLIER TC	105
MAYO-HEGAR NEEDLE HOLDERS	85-86	RASPATOR, MICRO FREER	131	TWEED LOOP FORMING PLIERS	99
MEAD 1A BONE ROUNDER	14	RASPATOR, MICRO RASPATOR / CHISEL	131	TWEED LOOP PLIER	104-105
MEAD BONE FILES	94	RASPATOR, MICRO-FREER	129	TWEEZER PERIODONTAL INSTRUMENTS	39
MEASURING LOOP	109	RASPATOR, NORDBERG	131	TWEEZERS	31
MEASURING LOOP, CASTROVIEJO	109	RASPATOR, PRICHARD	124	TWEEZERS	32
MEDIUM CEMENT CEMENT SPATULAS	75	RASPATOR, RASPTORY PERIOSTEAL ELEVATORS	95	TWEL-ON ELASTIC MODULE INSTRUMENT	97
MEDIUM PLACING/CONDENSING IMPLANTOLOGY INSTRUMENTS	114	RASPATOR, WAUTIER	131	UNIVERSAL DOLPHIN STYLE WIRE BENDING & CUTTING PLIERS	95
MEMBRANE POSITIONING INSTRUMENTS	118	RASPATOR, WILLIGER PERIOSTEAL ELEVATORS	95	UNIVERSAL FILLING INSTRUMENTS	49
MEMBRANE TWEEZERS KUEHNE	134	RASPATORY CHIPPING	131	UNIVERSAL FILLING INSTRUMENTS	54
MERIAM TWEEZERS	31	RASPATORY MICRO MOLT	131	UNIVERSAL NEEDLE HOLDERS	85
MERRIT A EXPLORERS	36	RASPATORY MOLT	131	UNIVERSITY OF MICHIGAN EXPLORERS	36
MERRIT B EXPLORERS	36	REGULAR TWEED ARCH FORMING PLIERS	104	UTILITY PLIER WEINGART TC	107
MERSHON CROWN REMOVER	90	RESTORATIVE INSTRUMENTS	51-53, 68, 70-72	V BEND STOP PLIER TC	106
METZENBAUM NEEDLE HOLDERS	85	RETRACTOR WITH ERGO GRIP	90	W. BARRY ROOTS ELEVATOR	25
METZENBAUM SCISSORS	83	RETRACTORS - MOUTH GAGS	78-79	WAHL BONE FILES	94
MICOR ADSON TISSUE FORCEP	133	RETRACTORS	80-82	WALDSAVHS WIRE BENDING AND CUTTING PLIERS	101
MICRO IRIS SCISSORS	83	RETRACTORS CHEEK RETRACTOR COMBINATION COMBINATION	80	WALL FILLING INSTRUMENTS	69
MICRO-FRIEDMAN BONE ROUNDER	14	RETRACTORS COMBINATION	81	WANGEN HOLDER	78
MILLER BONE FILES	94	RETRACTORS, LANGENBECK	82	WARD AMALGAM CARVERS	56
MILLER TWEEZERS	32	RETRACTORS, MINI-LANGENBECK	81	WARD FILLING INSTRUMENTS	69
MILLER	132	RETRACTORS, UNIQUE	81	WAX KNIVES	76
MINI LIGATURE CUTTERS	100	RETRO FILLING	48	WEDELSTAEDT	71
MINI PIN & LIGATURE CUTTER TC	106	REVERSED LIGATURE CUTTER ANGLED	102	WEINGART GENERAL UTILITY PLIER LONG MOUTH WITH TC	103
MIXING SPATULA WITH SHOVEL	124	RHODIUM MIRRORS	30	WEINGART PLIER MEDIUM	99-101
MODIED MCCALL	60	ROCHESTER-KOCHER 1X2 HAEMOSTATIC FORCEPS	87	WEINGART PLIER REGULAR WITH TC	103
MOLT BONE FILES	94	ROCHESTER-PEAN HAEMOSTATIC FORCEPS	87	WEINGART PLIER SLIM WITH TC	102
MOLT PERIOSTEAL ELEVATORS	95	ROOT ELEVATOR	15-29	WEINGART PLIER UNIVERSAL WITH TC	103
MORTONSEN FILLING INSTRUMENT	55	ROOT PLANNING FILES	94	WEINGART PLIER UTILITY WITH TC	103
MOUTH GAG MOLT	78	ROOT PLANNING FILES & BONE FILES	94	WEITLANDER CHEEK RETRACTORS	79
MOUTH MIRROR	37	ROOTS ELEVATOR	22	WEITLANER CHEEK RETRACTORS	79
MSY CEMENT SPATULAS	75	ROSER-KONIG CHEEK RETRACTORS	79	WERDELSTAEDT FILLING INSTRUMENTS	74
MULTIFUNCTIONAL METER	108	ROUND NOSE PLIER	104	WESTON CEMENT SPATULAS	75
NAKAWALNI DENTAL LABORATORY INSTRUMENTS	77	ROUNDED CONE	73	WIDE MATRIX RETAINERS	91
NANCE LOOP FORMING PLIERS	99	ROUNDED-CONE FILLING INSTRUMENTS	49	WILLIAM PROBE SET	38
NANCE PLIER	105	RUBBER DAM CLAMPS	89	WILLIAMS EXPLORERS	36
NARROW MATRIX RETAINERS	91	RUBBER DAM CLAMPS FORCEPS	89	WINGURT PLIER SLIM	105
NEEDLE HOLDERS	85-86	RUSSIAN LONG TISSUE FORCEPS	134	WINGURT UTILITY PLIER	105
NEUMANN SCISSORS	84	RUSSIAN TISSUE FORCEPS	134	WINTER ROOTS ELEVATOR	25
NOYES SCISSORS	84	SCALER TRAY	148	WIRE BENDING & LOOP FORMING PLIERS	99
OCCULSAL ANATOMY INSTRUMENT	113	SCALER/CURETTE SETS	60	WISDOM ROOTS ELEVATOR	21
OH, PERIOSTEAL ELEVATORS	95	SCALER/CURETTE SETS INSTRUMENTS	61	WOODEN HANDLE	76
OLSEN-HEGAR NEEDLE HOLDER WITH SCISSORS	97	SCHURE BAND SEATER	97	WOODSON FILLING INSTRUMENTS	49
OREGON PLUGGERS/CONDENSERS	51	SEPARATING ELASTIC PLIER	88	YOUNG PLIER WITH GROOVED	105
ORTHO BAND PUSHER SCALER	98	SELIDIN PERIOSTEAL ELEVATORS	95	YOUNG TONGUE FORCEPS	99
ORTHO INSTRUMENT	97	SELIDIN RETRACTOR	82	YOUNG WIRE BENDING & LOOP FORMING PLIERS	99
ORTHO LIGATURE DIRECTOR SINGLE ENDED	98	SELIDIN ROOT ELEVATORS	15-18, 25	ZAHLE CEMENT SPATULAS	75
ORTHO LIGHT BAND PUSHER SCALER	97-98	SELF LOCKING GROOVED	133		
ORTHO LIGHT DOUBLE ENDED LIGATURE DIRECTOR SCALER	98	SELF-LOCKING TWEEZER	32		
ORTHO LIGHT DOUBLE ENDED LIGATURE DIRECTOR	98	SEMKEN TAYLOR TWEEZERS	31		
ORTHO LIGHT DOUBLE ENDED LIGATURE SCALER	98	SICKLE PERIODONTAL INSTRUMENTS	39		
ORTHO LIGHT DOUBLE ENDED LIGATURE SCALER/DIRECTOR	98	SICKLE SCALERS INSTRUMENTS	58		
ORTHO LIGHT LIGATURE DIRECTOR DOUBLE ENDED	98	SINGLE ENDED PROBE	33		
ORTHO LIGHT SCALER DOUBLE ENDED	97	SINUS LIFT ELEVATOR	115-116		



AllWell Instruments co.

The name of Health Cure Instruments

Add: Sardar Pura Defence Road
Muzafar Pur S.I .E 51340 Sialkot

Tel: 0092 52 3242356 Fax:0092 52 3242356

CELL: 092 321 6121965

info@allwellinst.com

imranasghar65@gmail.com

www.allwellinst.com



CERTIFIED



cGMP F.D.A
USA