









**AllWell Instruments co.**

**The name of Health Cure Instruments**



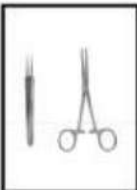
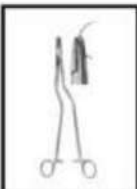





**SURGICAL  
INSTRUMENTS  
CATALOGUE**

# TABLE OF CONTENTS

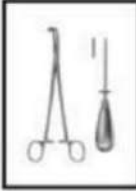





	<b>DESCRIPTION</b>	<b>SECTION</b>	<b>PAGE #</b>	
01:	<b>Diagnostic, Anaesthesia, Scalpels &amp; Knives</b>	<b>01</b>	<b>1 - 22</b>	
02:	<b>Scissors</b>	<b>02</b>	<b>23 - 51</b>	
03:	<b>Forceps, Clamps</b>	<b>02</b>	<b>52 - 95</b>	
04:	<b>Needle Holders, Micro Needle Holders</b>	<b>02</b>	<b>96 - 101</b>	
05:	<b>Suture Instruments, Needles, Probes, Applicators, Pocket Instruments Set.</b>	<b>02</b>	<b>102 - 114</b>	
06:	<b>Hooks, Retractors, Spatulas, Spreaders, Abdominal Retractors</b>	<b>03</b>	<b>115 - 167</b>	
07:	<b>Forceps, Intestinal Clamps, Specula, Biopsy Forceps, Anusscopes</b>	<b>03</b>	<b>168 - 193</b>	



# TABLE OF CONTENTS

DESCRIPTION	SECTION	PAGE #	
08: Gall Duct Forceps / Probes / Scissors / Kidney Forceps, Urinary Instruments, Trocars	03	194 - 208	
09: Vaginal Specula & Retractors	04	209 - 220	
10: Utrine Dilators, Probes, Forceps, Myoma Instruments	04	221 - 236	
11: Biopsy Instruments, Utrine Curettes / Scoops	04	237 - 245	
12: Obstetrics Instruments	04	246 - 254	
13: Tracheotomy, Cardiovascular & Thoracic Surgery	05	255 - 309	
14: Bone Punches & Rongeurs	05	310 - 318	

# TABLE OF CONTENTS

	DESCRIPTION	SECTION	PAGE #	
15:	Amputation, Elevators, Saws, Raspatories, Bone Livers, Bone Files & Curettes	06	319 - 347	
16:	Mallets, Tampers, Chisels, Gauges, Bone Holding Forceps, Bone Rongeurs, Bone Cutting Forceps, Meniscus Instruments	06	348 - 379	
17:	Wire Extension, Finger Nail Instruments	06	380 - 392	
18:	Plaster Instruments	07	393 - 397	
19:	Suction Instruments	07	398 - 404	
20:	TUNGSTEN CARBIDE INSERTS	07	405 - 421	
21:	HOSPITAL WARES	07	422 - 432	



# Section - 01



AllWell Instruments Co.  
The name of Health Care Instruments

**Pages 01 - 22**

- ★ Diagnostic
- ★ Anaesthesia
- ★ Scalpels
- ★ Knives



## Percussion Hammers & Aesthesiometers



 AllWell Instruments co.  
The name of Health Cure Instruments





# Stethoscopes



**01-2010**  
**PINARD**  
of aluminium  
Size: 155 mm



**01-2011**  
**aus Holz**  
Wooden  
Size: 145 mm



**01-2012**  
**BOWLES**  
Stethoscope With  
Diaphragm,  
In Plastic Pouch



**01-2013**  
**ANESTOPHON**  
∅47mm



**01-2014**  
**FORD-BOWLES**  
Combination Stethoscope  
With Diaphragm and Bell  
Dual Chest Piece  
With Two Outlets



**01-2015**  
**BOWLES**  
Stethoscope With  
Diaphragm,  
Flat Model,  
Suitable Also  
For Anaesthesia  
Chest Piece Only  
40 mm Diam



AllWell Instruments co.

The name of Health Cure Instruments

AllWell Instruments co.

The name of Health Cure Instruments

## Head Mirrors & Head Bands



**01-2016**  
**ZIEGLER** Ø 90mm  
 Head mirror only  
 with rubber coating



**01-2017**  
**ZIEGLER** Ø 90mm  
 Head mirror only  
 with metal coating



**01-2018**  
**ZIEGLER**  
 Head band of plastic, black only

**01-2019**  
**ZIEGLER**  
 Head band of plastic, white only



**01-2020**  
**MURPHY**  
 Head band of celluloid, white only



**01-2021**  
 Head band of plastic,  
 white, soft pattern



**01-2022**  
 Head mirror  
 with black plastic head  
 band



# Head Lights



**01-2026**  
spare bulb

**01-2023**  
**CLAR**  
Head light, 6 volt, with adjustable joint, white celluloid head band, cord with plugs for transformer

**01-2024**  
White celluloid head band, only, for **01-2023**

**01-2025**  
Spare mirror only, for **01-2023**



**01-2027**  
**CLAR**  
Head light, 6 volt, with adjustable joint, white celluloid head band, with foam rubber pad and cord with plugs for transformer

**01-2028**  
White celluloid head band, only, for head light

**01-2029**  
mirror only, for head light

**01-2030**  
spare foam rubber pad, for head band



**01-2033**  
spare bulb

**01-2032**  
**JANSEN**  
Head light, 6 volt, with adjustable joint, white plastic head band, cord with plugs for transformer



**01-2035**  
spare bulb

**01-2034**  
**LANGENBECK**  
Head light, 3.7 volt, with adjustable joint, white plastic head band, cord with plugs for transformer



**01-2036**  
**HERBERHOLD**  
Pocket-Accu, 6 volts, with cord for head lights



**01-2037**  
Extension cord only, to connect the accu to the cord of the head lights



**01-2038**  
Charging Set for pocket accu **01-2036**  
mains current: 220-240 volts, 50-60 Hz



**01-2039**  
220 volt / 220 volts  
**01-2040**  
120 volt / 120 volts  
Transformer

## Tongue Depressors, Retractors

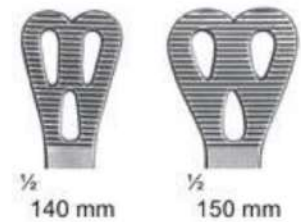
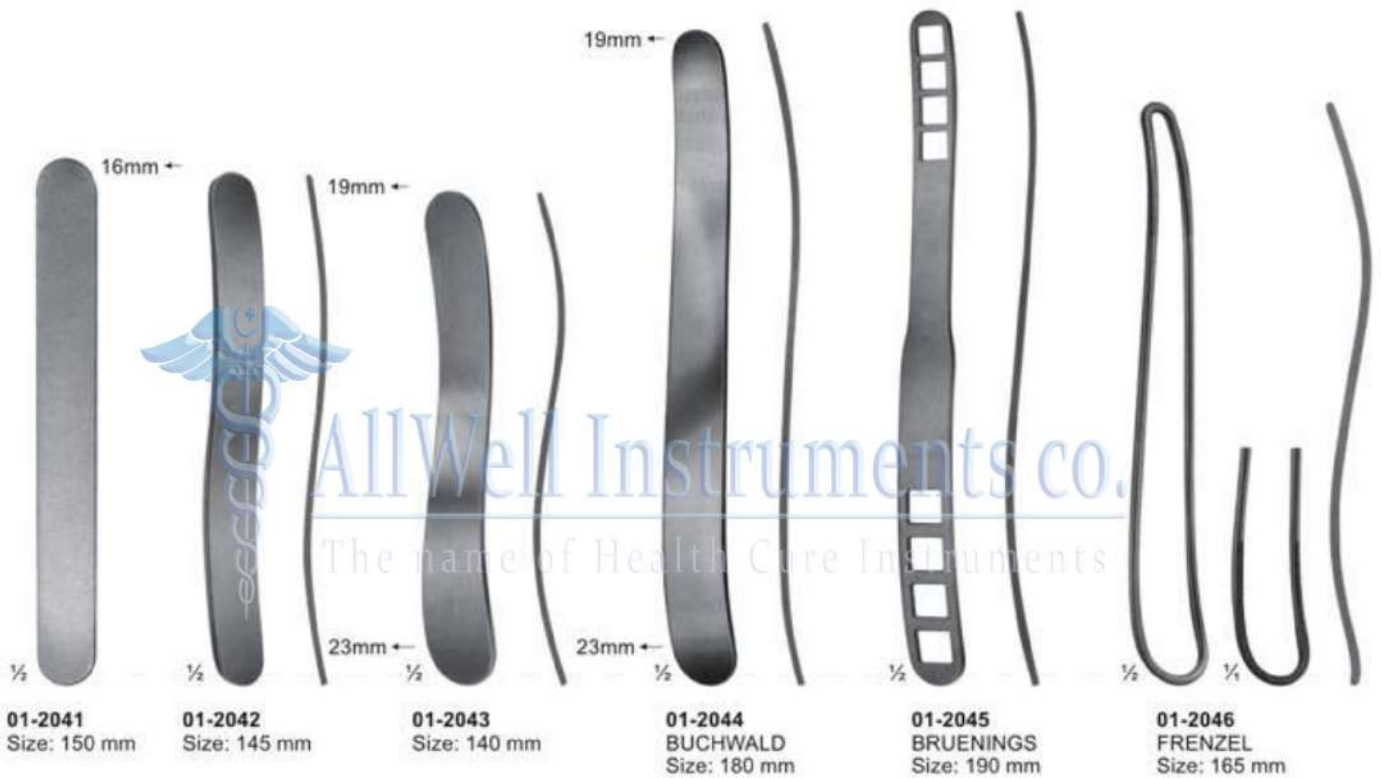

01-2047  
SIMPLEX  
Cheek and  
Lipretractor  
Size: 110 mm



01-2048-01-2050  
STERNBERG  
Cheek and Lipretractor  
01-2048 120mm  
01-2049 140mm  
01-2050 160mm



01-2051  
TOBOLD  
Tongue depressor  
Size: 145 mm



01-2052  
ANDREW  
Tongue depressor  
Size: 110 mm



01-2053-01-2054  
WIEDER  
Tongue depressor  
01-2053 140mm  
01-2054 150mm



## Mouth Gags And Tongue Forceps



1/2  
**01-2055**  
**SCHIMMELBUSCH**  
Ether Mask



1/2  
**01-2056**  
**HEISTER**  
Mouth Gag  
Size: 130 mm



1/2  
**01-2057**  
**FERGUSON-ACKLAND**  
Mouth Gag  
Size: 145 mm



1/2  
**01-2058**  
**DENHARDT**  
Mouth Gag With  
Silicon Inserts,  
Interchangeable  
Size: 125 mm



1/2  
**01-2059-01-2060**  
**ROSER KOENIG**  
Mouth Gag  
Size: **01-2059** 160mm  
**01-2060** 185mm



1/2  
**01-2061**  
**YOUNG**  
Size: 165 mm



1/4  
**01-2062**  
1 Pair Of  
Rubber Pads

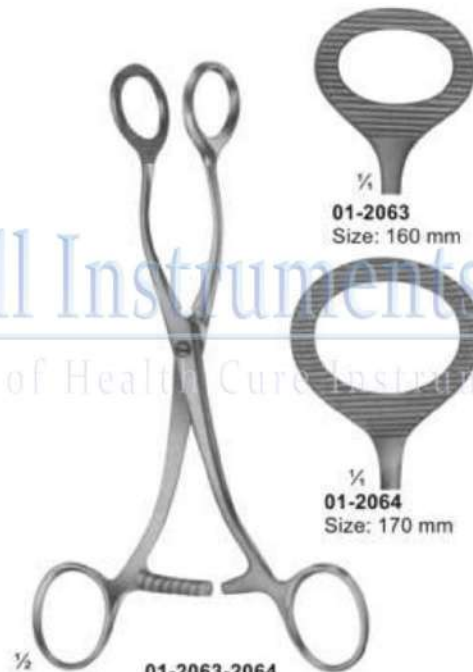

1/2  
**01-2063-2064**  
**COLLIN**



1/4  
**01-2063**  
Size: 160 mm



1/4  
**01-2064**  
Size: 170 mm



1/2  
**01-2065**  
**HEYWOOD-SMITH modif.**  
Size: 215 mm

# Blood Lancets & Laryngeal Mirrors

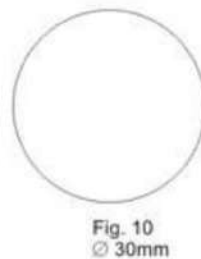
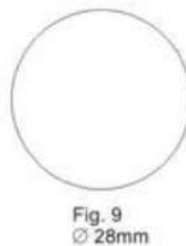
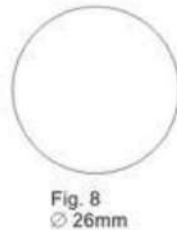
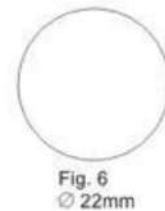
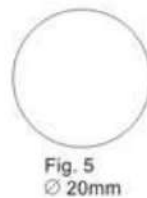
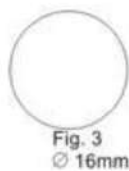
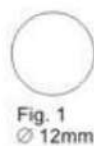
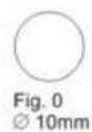
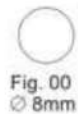



## Diagnostic Sets



**01-2074 - 01-2076**  
MAGILL  
Catheter Introducing  
Forceps



**01-2074**  
Infants  
Size: 150 mm



**01-2075**  
Children  
Size: 200 mm



**01-2076**  
Adults  
Size: 250 mm



**01-2077**  
Medium battery handle  
only, 25 mm diam.



**01-2078**  
Spare bulb  
2.7 volt, for  
Otoscopies etc.



**01-2079**  
Spare bulb  
2.6 volt, for  
ophthalmoscopes



**01-2080**  
Otoscope Set, Consists Of  
Battery Handle Without Batteries,  
3 Ear Specula, 1 Bulb In Velvet Lined Case



**01-2081**  
Diagnostic Set, Otoscope With Three Specula,  
Nasal Speculum, Lamp Holder, Two Laryngeal  
Mirrors, Tongue Blade Holder

# Laryngoscopes



**01-2082**  
**MILLER**  
Laryngoscope Set, Consists Of Battery Handle ( Without Battery )  
With Five Miller Laryngoscope Blades, Fig 1 to 5



**01-2082 A** Fig. 0 Working Length, 55 mm (Baby's)  
**01-2082 B** Fig. 1 Working Length, 80 mm (Children's)  
**01-2082 C** Fig. 2 Working Length, 130 mm (Adolescent's)  
**01-2082 D** Fig. 3 Working Length, 170 mm (Women's)  
**01-2082 E** Fig. 4 Working Length, 180 mm (Men's)



**01-2083**  
**GUEDEL-NEGUS**  
Laryngoscope Set, Consists Of Battery Handle ( Without Battery )  
With Four Miller Laryngoscope Blades

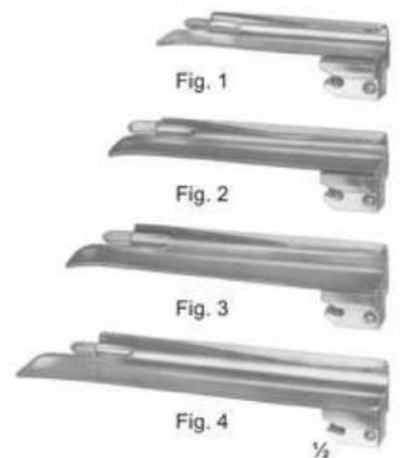

**01-2083 A** Fig. 1 Working Length, 70 mm (Children's)  
**01-2083 B** Fig. 2 Working Length, 90 mm (Adolescent's)  
**01-2083 C** Fig. 3 Working Length, 110 mm (Women's)  
**01-2083 D** Fig. 4 Working Length, 135 mm (Men's)



# Laryngoscopes



**01-2084**  
McINTOSH  
Laryngoscope Set, Consists Of Battery Handle ( Without Battery )  
With Three McIntosh Blades, Fig. 1, Fig. 2, Fig. 3

**01-2085**  
McINTOSH  
Laryngoscope Set, Consists Of Battery Handle ( Without Battery )  
With Five McIntosh Blades, Fig. 0, Fig. 1, Fig. 2, Fig. 3, Fig. 4

**01-2086**  
FOREGGER  
Laryngoscope Set, Consists Of Battery Handle ( Without Battery )  
With Three Foregger Blades,  
Fig. 1, Fig. 2, Fig. 3,

**01-2087**  
FOREGGER  
Laryngoscope Set, Consists Of Battery Handle ( Without Battery )  
With Four Foregger Blades,  
Fig. 1, Fig. 2, Fig. 3, Fig. 4,



Fig. 0



Fig. 1



Fig. 2



Fig. 3



Fig. 4

**01-2085 A** Fig. 0 Working Length, 55 mm (Baby's)  
**01-2085 B** Fig. 1 Working Length, 75 mm (Children's)  
**01-2085 C** Fig. 2 Working Length, 90 mm (Adolescent's)  
**01-2085 D** Fig. 3 Working Length, 110 mm (Women's)  
**01-2085 E** Fig. 4 Working Length, 135 mm (Men's)



Fig. 1



Fig. 2



Fig. 3



Fig. 4

**01-2086 A** Fig. 1 Working Length, 70 mm (Children's)  
**01-2086 B** Fig. 2 Working Length, 90 mm (Adolescent's)  
**01-2086 C** Fig. 3 Working Length, 110 mm (Women's)  
**01-2086 D** Fig. 4 Working Length, 135 mm (Men's)



**01-2088**  
Fiber Optic  
Battery Handle  
30mm diam.



**01-2089**  
Fiber Optic  
Battery Handle  
18mm diam.



**01-2090**  
Replacement Lamp  
( Krypton ) 2.5 V

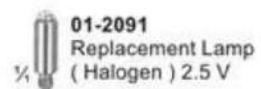

**01-2091**  
Replacement Lamp  
( Halogen ) 2.5 V

## Examination & Measuring Instruments

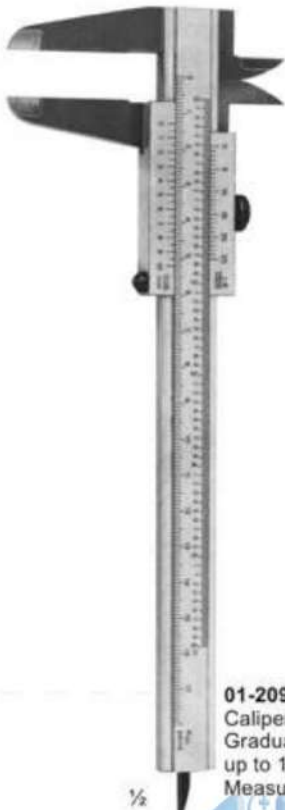

1/2

**01-2092**  
Caliper Of Aluminium  
Graduated in mm & inches  
up to 180mm  
Measuring Range up to 139mm



1/2

**01-2093**  
VERNIER  
Universal Caliper Of Steel  
Graduated in mm & inches  
up to 180mm  
Measuring Range up to 120mm  
with Vernier in 1/10mm & 1/16"



1/2

**01-2094**  
CARROLL  
Size: 145 mm  
Finger Goniometer



1/2

**01-2095**  
TOWNLEY  
Graduated in  
mm & inches  
Size: 115 mm



1/2

**01-2096**  
COLLIN  
Druck Pressure 72 kg  
Size: 125 mm



1/2

**01-2097**  
BERTILLON  
Caliper For Measuring The Head  
Size: 320 mm



1/2

**01-2098**  
CASTROVIEJO  
Caliper  
Size: 75mm



1/2

**01-2099**  
MOLTGEN  
Goniometer

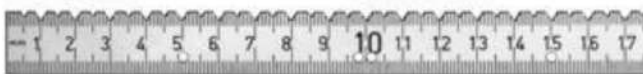

**01-2100A**  
Size: 150 mm

**01-2100**  
Size: 500 mm



# Dissecting Knives



**01-2101 - 01-2110**  
Fig. 1 - 10  
With Metal Handle



**01-2101**  
Fig. 1  
Size: 30mm  
15cm



**01-2102**  
Fig. 2  
Size: 36mm  
15cm



**01-2103**  
Fig. 3  
Size: 40mm  
15.5cm



**01-2104**  
Fig. 4  
Size: 45mm  
16cm



**01-2105**  
Fig. 5  
Size: 50mm  
16cm



**AllWell Instruments co.**  
The name of Health Cure Instruments



**01-2106**  
Fig. 6  
Size: 27mm  
15cm



**01-2107**  
Fig. 7  
Size: 35mm  
15cm



**01-2108**  
Fig. 8  
Size: 40mm  
16cm



**01-2109**  
Fig. 9  
Size: 47mm  
16cm



**01-2110**  
Fig. 10  
Size: 50mm  
17cm

# Autopsy & Cartilage Knives



01-2111  
Size: 255 mm  
wooden handle.

01-2112  
210mm  
with wooden handle

01-2113 - 01-2115  
WALB  
with wooden handle

01-2116 - 01-2118  
VIRCHOW  
with hollow handle



# Scalpels, Tenotomes & Resection Knives

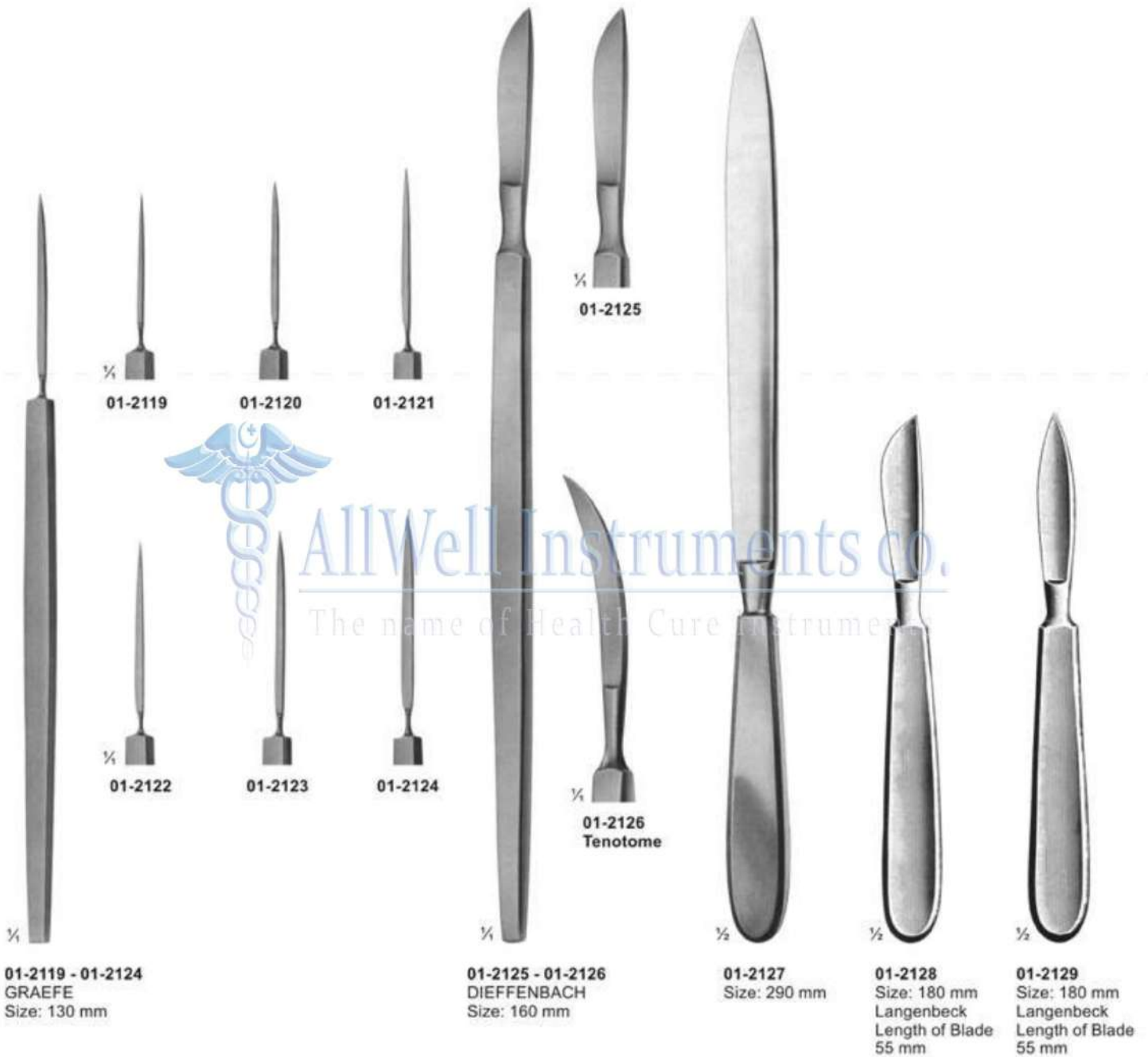

01-2119 - 01-2124  
GRAEFE  
Size: 130 mm

01-2125 - 01-2126  
DIEFFENBACH  
Size: 160 mm

01-2127  
Size: 290 mm

01-2128  
Size: 180 mm  
Langenbeck  
Length of Blade  
55 mm

01-2129  
Size: 180 mm  
Langenbeck  
Length of Blade  
55 mm

# Scalpels, Tenotomes

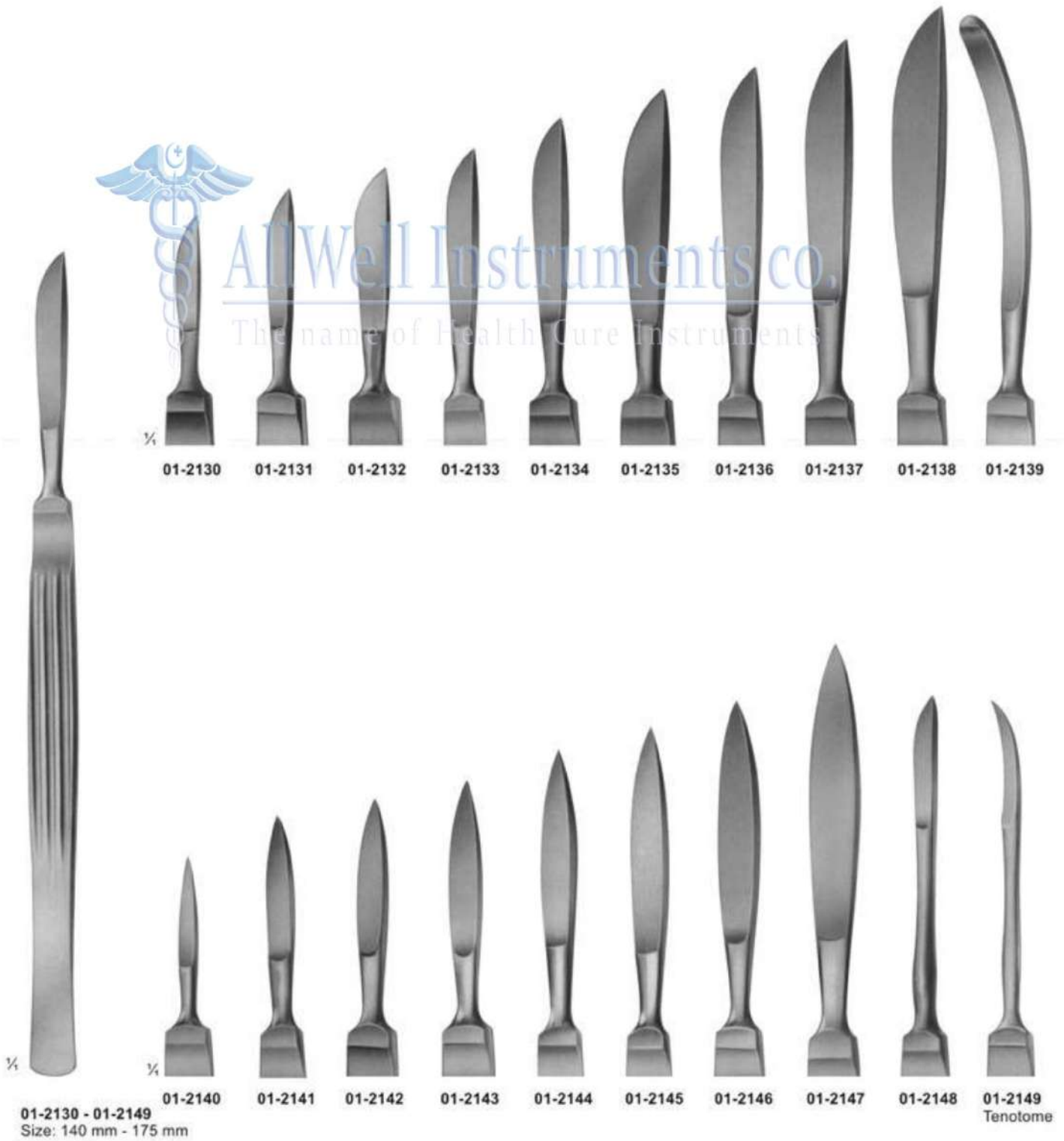



# Amputating Knives, Cartilage Knives, Autopsy Knives

Double Cutting

Double Cutting



LISTON  
01-2150  
Size: 130 mm  
01-2151  
Size: 160 mm  
01-2152  
Size: 190 mm  
01-2153  
Size: 220 mm

Blade Length  
Amputating Knives

01-2154  
CATLIN  
Size: 160 mm  
Blade Length  
Amputating  
Knives

01-2155  
LANGENBECK  
Size: 120 mm  
Blade Length  
Flap Knives

01-2156  
Size: 110 mm  
Blade Length  
Interosseous  
Knives

01-2157  
Size: 55 mm  
Blade Length  
With Raspatory,  
Wooden Handle

01-2158  
Size: 70 mm  
Blade Length  
Wooden Handle

01-2159  
Size: 80 mm  
Blade Length  
Metal Handle

01-2160  
Size: 195 mm  
Blade Length  
Metal Handle

# Cone Knives, Myomatome, Trigeminal & Tonsil Knives





# Scalpels, Dura Knives & Comedone Extractors

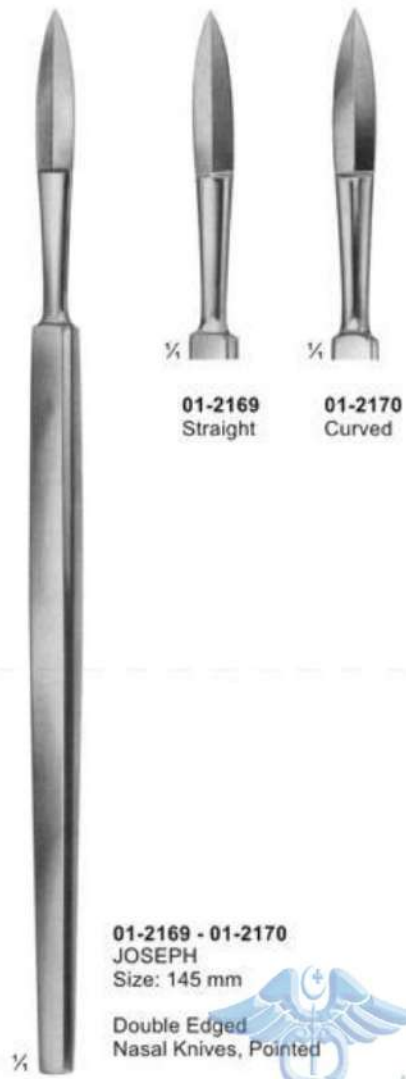

**01-2169**  
Straight

**01-2170**  
Curved

**01-2169 - 01-2170**  
JOSEPH  
Size: 145 mm

Double Edged  
Nasal Knives, Pointed

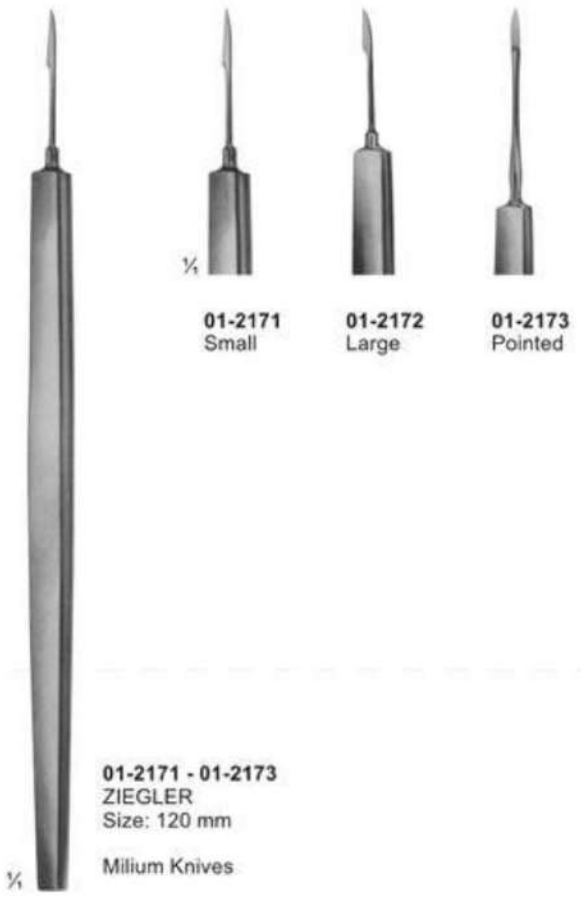

**01-2171**  
Small

**01-2172**  
Large

**01-2173**  
Pointed

**01-2171 - 01-2173**  
ZIEGLER  
Size: 120 mm

Milium Knives



**01-2174**  
VIDAL  
Lupus Scraper  
Size: 135 mm

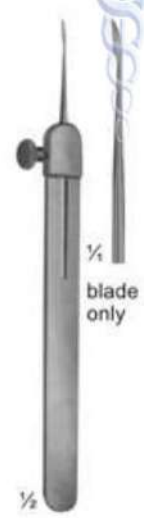

**01-2175**  
MONCORPS  
Milium Knives  
Size: 130 mm



**01-2176**  
SAALFELD  
Size: 100 mm

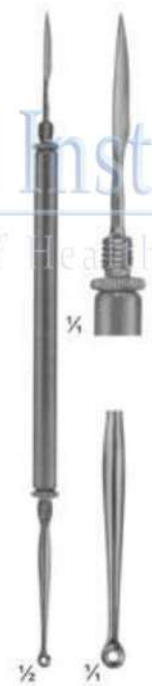

**01-2177**  
HEBRA  
Size: 180 mm



**01-2178**  
Size: 145 mm



**01-2179**  
UNNA  
Size: 145 mm

AllWell Instruments Co.  
The name of Health Cure Instruments

## Razor Blade Holders & Breakers



¼  
**01-2180**  
TROUTMAN-CHRIS  
Size: 90 mm  
Handle Diameter 5.5 mm

¼  
**01-2181**  
TROUTMAN-CHRIS  
Size: 90 mm  
Handle Diameter 5.5 mm

¼  
**01-2182**  
Size: 110 mm

¼  
**01-2183**  
CASTROVIEJO  
Size: 130 mm  
Handle Diameter 8 mm

¼  
**01-2184**  
Size: 185 mm  
Razor Blade  
Breaker & Holder,  
Straight



# Scalpel Handles



**01-2185**  
STANDARD  
No. 4  
Solid

**01-2186**  
Double Handle  
No. 4 + No. 3  
Solid

**01-2187**  
No. 4 L  
Straight  
Solid

**01-2188**  
No. 4 L  
Solid Angled

**01-2189**  
COLLIN  
No. 8  
Hollow

**01-2190**  
COLLIN  
No. 9  
Hollow

**01-2191**  
Plastic  
No.4

# Scalpel Handles



**01-2192**  
STANDARD  
No. 3  
Solid  
Size:12cm

**01-2193**  
No. 3  
Solid  
Size:12cm  
solid handle  
style as  
No.4

**01-2194**  
No. 3  
Solid  
Size:12cm  
cm-graduation

**01-2195**  
No. 3 L  
Straight  
Solid, long  
Size:21.5cm

**01-2196**  
No. 3 L  
Angled  
Solid, long  
Size:21cm

**01-2197**  
No. 7  
Solid  
Size:16cm

**01-2198**  
No. 7 K  
Solid, short  
Size:12.5cm

**01-2199**  
No.3  
Size:15.5cm  
with round  
hollow handle

**01-2200**  
No. 3  
Straight  
Solid,  
Round  
Size:14.5cm

**01-2201**  
No. 3  
Angled  
Solid, Round  
Size:14cm



## Razors & Dermatomes



½

**01-2202**  
SCHINK  
Size: 310 mm  
Complete with 2  
skin fixing plates  
and 1 blade.  
Adjustable from  
0.1 to 2.0mm



½

**01-2203**  
SCHINK  
Spare Blade



½

**01-2204**  
SCHINK  
Skin Fixing Plate



½

**01-2205**  
SILVER  
Size: 190 mm  
For Usual  
Razor Blades



½

**01-2206**  
Size: 75 mm  
Cutting Length



½

**01-2207**  
Size: 80 mm  
Cutting Length



## Section - 02



All Well Instruments Co.  
The name of Health Care Instruments

**Pages 23-114**

- ★ Scissors
- ★ Forceps, Clamps
- ★ Needle Holders,  
Micro Needle Holders
- ★ Suture Instruments,  
Needles, Probes, Applicators,  
Pocket Instruments Set.



# Micro Scissors, "Spring Type" Flat Handles

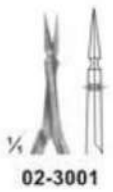

**02-3001**



**02-3002**



**02-3003**

**02-3001 - 02-3003**  
VANNAS  
Size: 85 mm



**02-3004**  
angled to side



**02-3005**

**02-3004 - 02-3005**  
CASTROVIEJO  
Size: 95 mm

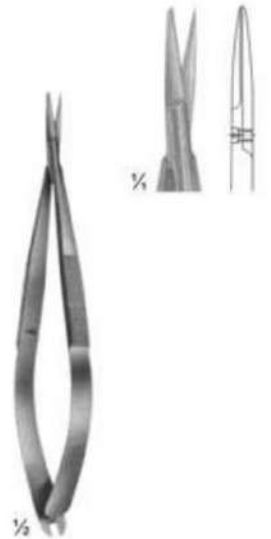

**02-3006**  
NOYES  
Size: 125 mm

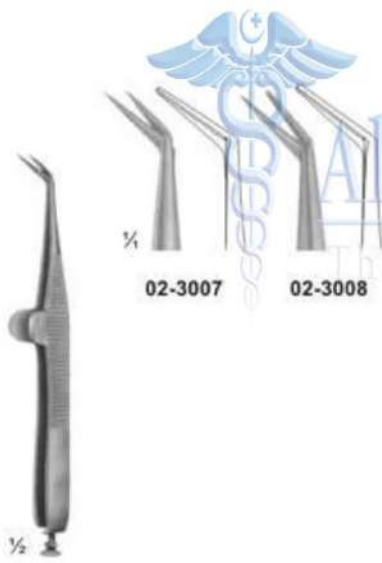

**02-3007**

**02-3008**

**02-3007 - 02-3008**  
WECKER  
Eye Scissor  
Size: 110 mm



**02-3009**  
CASTROVIEJO  
Eye Scissor  
Size: 115 mm

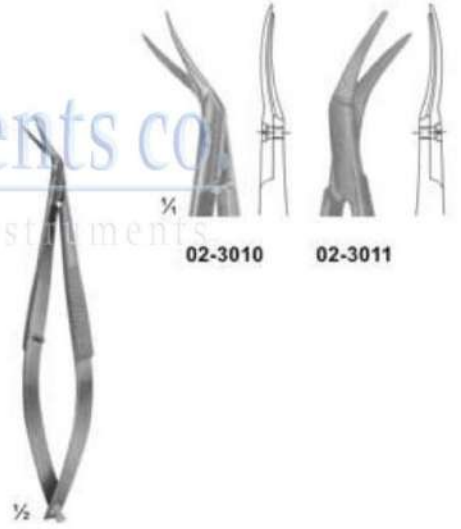

**02-3010**

**02-3011**

**02-3010 - 02-3011**  
CASTROVIEJO  
Eye Scissor  
Size: 110 mm



# Micro Scissors, "Spring Type" Flat Handles and Cross-Serration

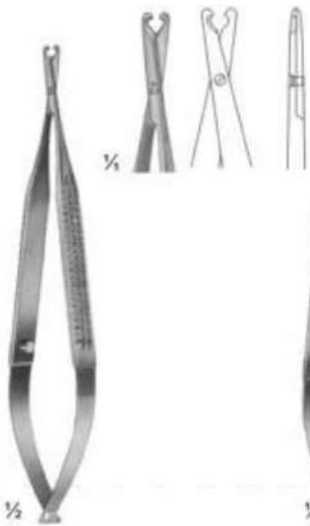

**02-3012**  
BIEMER  
Vein Scissor  
Size: 130 mm



**02-3013 - 02-3014**  
Size: 120 mm



**02-3013 02-3014**



**02-3015 - 02-3016**  
Size: 160 mm



**02-3015**



**02-3016**



**02-3017 - 02-3018**  
VANNAS  
Size: 160 mm

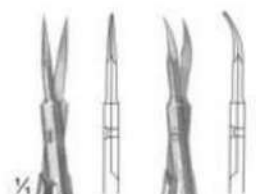

**02-3017**

**02-3018**



**02-3019**  
CASPAR  
Micro Scissor Curved



AllWell Instruments Co.  
The name of Health Care Instruments



**02-3020 - 02-3022**  
Micro Dissecting Scissor  
Size: 145 mm



**02-3020**



**02-3021**



**02-3022**

# Micro Scissors, "Spring Type" Bayonet Shape



**02-3023**  
YASARGIL  
Size: 245 mm



**02-3024**  
45°  
Nagel



**02-3025**  
45°



**02-3024 - 02-3025**  
Laterally Angled  
Size: 200 mm



**02-3026**  
Laterally Angled  
Size: 190 mm



**02-3027**



**02-3028**



**02-3027 - 02-3028**  
YASARGIL  
Size: 225 mm

## Delicate Scissors

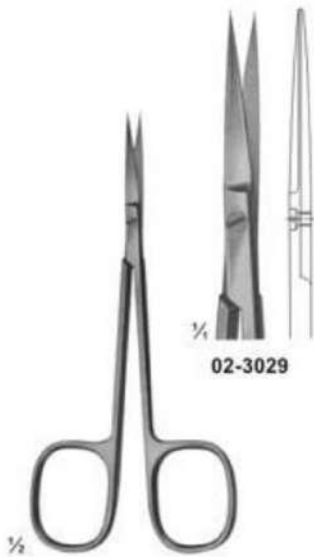

1/4  
**02-3029**



**02-3030**

**02-3029-02-3030**  
Size: 120 mm

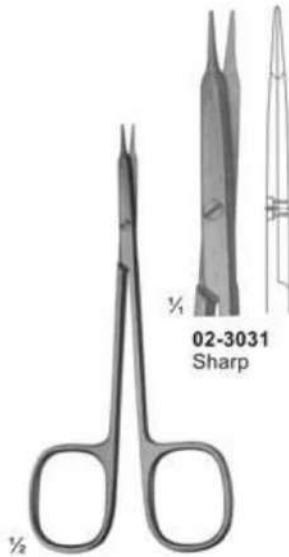

1/4  
**02-3031**  
Sharp



**02-3032**  
Sharp



**02-3033**  
Blunt

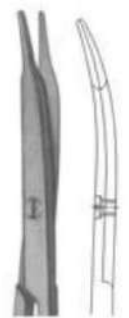

**02-3034**  
Blunt

**02-3031 - 02-3034**  
STEVENS  
Dissecting Scissors  
Size: 115 mm

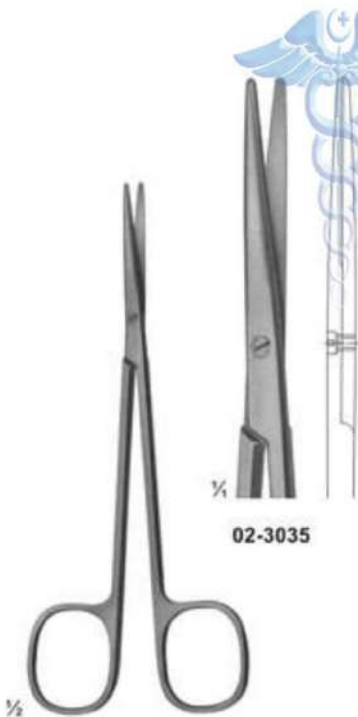

1/4  
**02-3035**



**02-3036**

**02-3035 - 02-3036**  
METZENBAUM  
Dissecting Scissors  
Size: 145 mm



1/4  
**02-3037**  
RAGNELL  
Size: 135 mm



**02-3038**  
RAGNELL  
Size: 135 mm



**02-3039**  
Size: 150 mm

**02-3037 - 02-3039**  
Special flat points for  
dissecting and  
undermining the skin



## Delicate Scissors

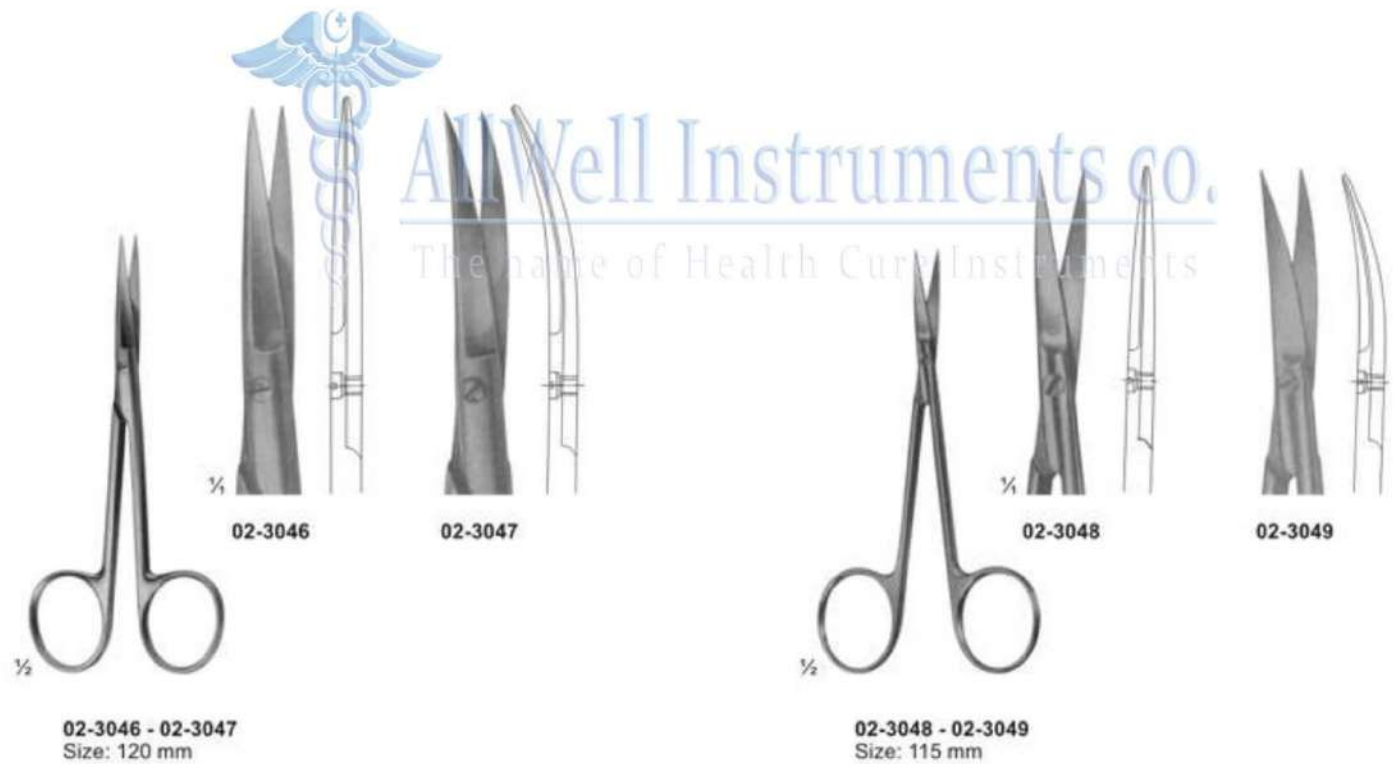

## Delicate Scissors

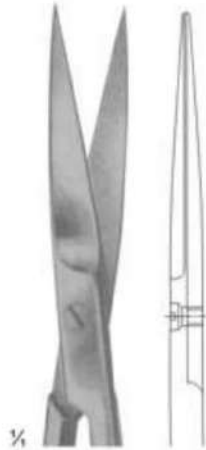

02-3050

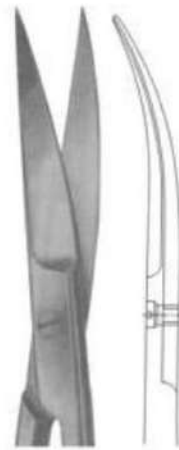

02-3051



02-3052

02-3050 - 02-3052  
Size: 120 mm



02-3053



02-3054



02-3055

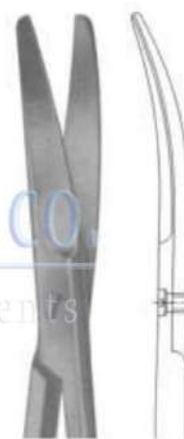

02-3056

02-3053 - 02-3056  
Size: 130 mm

## Delicate Scissors

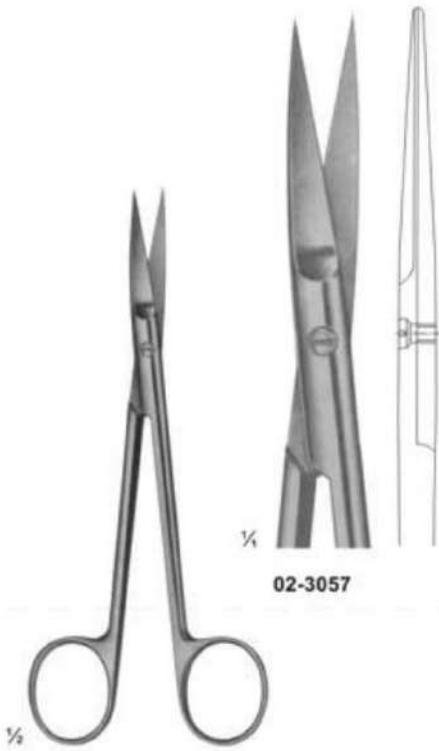

**02-3057**

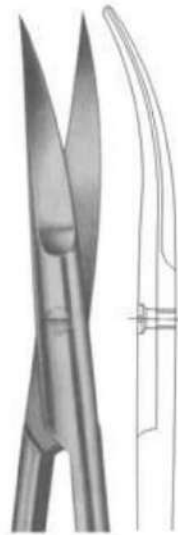

**02-3058**

**02-3057 - 02-3058**  
**JOSEPH**  
Size: 150 mm

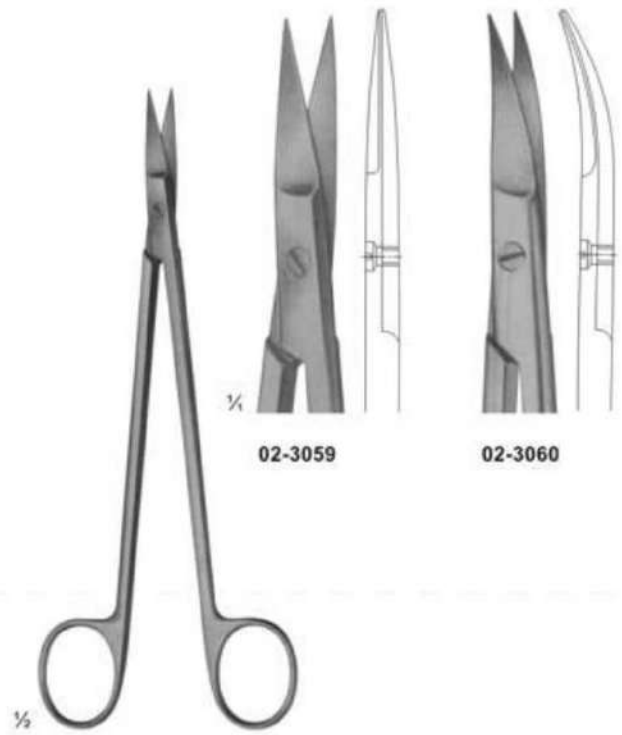

**02-3059**

**02-3060**

**02-3059 - 02-3060**  
**KELLY**  
Size: 175 mm



**AllWell Instruments co.**  
The name of Health Care Instruments



**02-3061**  
**QUINBY**  
Size: 130 mm

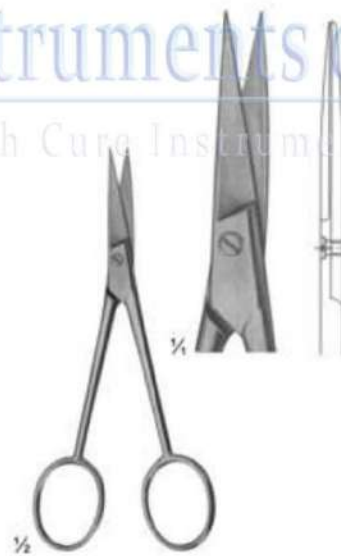

**02-3062**  
Size: 110 mm



# Surgical Scissors



**02-3063 - 02-3071 (Standard Types)**  
 02-3063 ( 105 mm )  
 02-3064 ( 115 mm )  
 02-3065 ( 130 mm )  
 02-3066 ( 145 mm )  
 02-3067 ( 150 mm )  
 02-3068 ( 165 mm )  
 02-3069 ( 175 mm )  
 02-3070 ( 185 mm )  
 02-3071 ( 200 mm )

**02-3063**  
Size: 105 mm

**02-3071**  
Size: 200 mm

**02-3072 - 02-3078 (Standard Types)**  
 02-3072( 115 mm )  
 02-3073 ( 130 mm )  
 02-3074 ( 145 mm )  
 02-3075 ( 150 mm )  
 02-3076 ( 165 mm )  
 02-3077 ( 175 mm )  
 02-3078( 185 mm )

**02-3072**  
Size: 115 mm

**02-3078**  
Size: 185 mm



**02-3079 - 02-3082**  
Slender Types

**02-3079** 130 mm  
**02-3080** 145 mm

**02-3081** 130 mm  
**02-3082** 145 mm

**02-3083 - 02-3084**  
For Wound Edges  
1 Blade Serrated

**02-3083**  
130 mm

**02-3084**  
130 mm

# Surgical Scissors

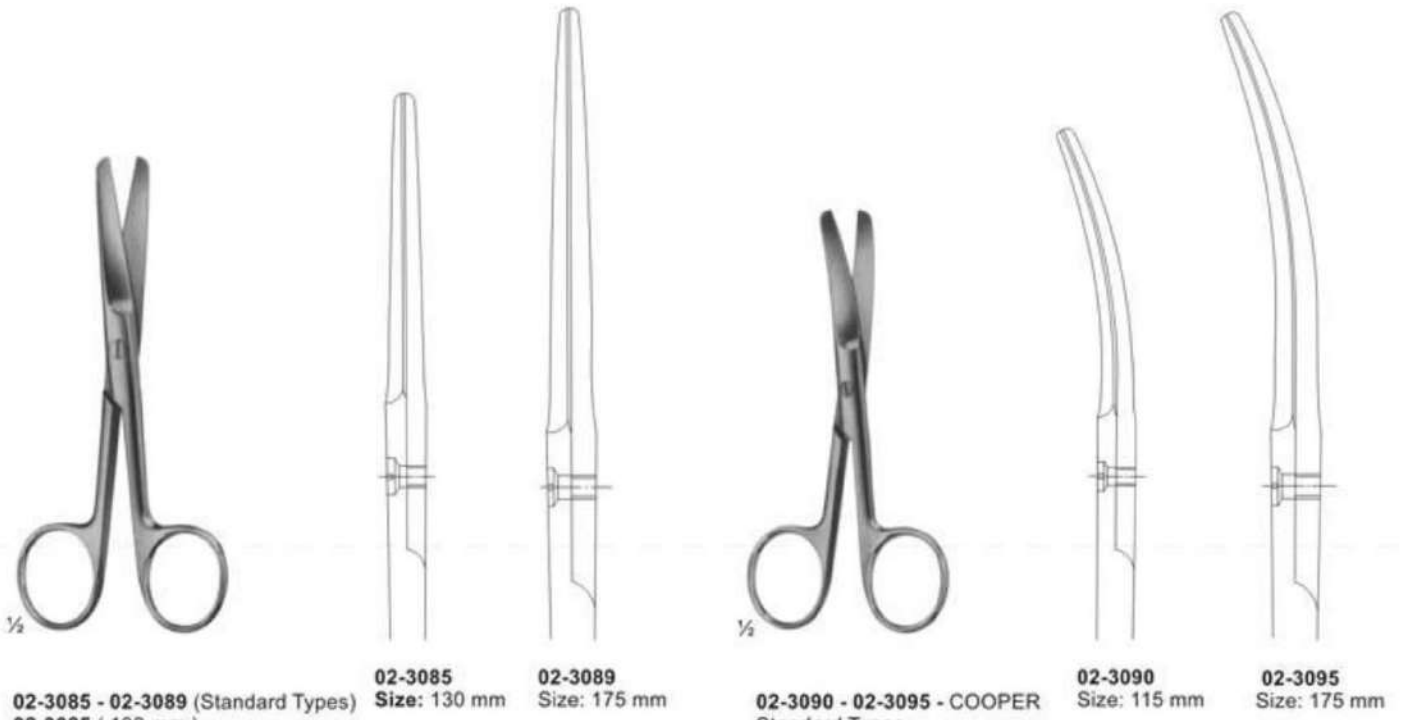

**02-3085 - 02-3089** (Standard Types)  
**02-3085** ( 130 mm )  
**02-3086** ( 145 mm )  
**02-3087** ( 150 mm )  
**02-3088** ( 165 mm )  
**02-3089**( 175 mm )

**02-3085** Size: 130 mm  
**02-3089** Size: 175 mm

**02-3090 - 02-3095 - COOPER**  
 Standard Types  
**02-3090** ( 115 mm )  
**02-3091** ( 130 mm )  
**02-3092** ( 145 mm )  
**02-3093** ( 150 mm )  
**02-3094** ( 165 mm )  
**02-3095** ( 175 mm )

**02-3090** Size: 115 mm  
**02-3095** Size: 175 mm

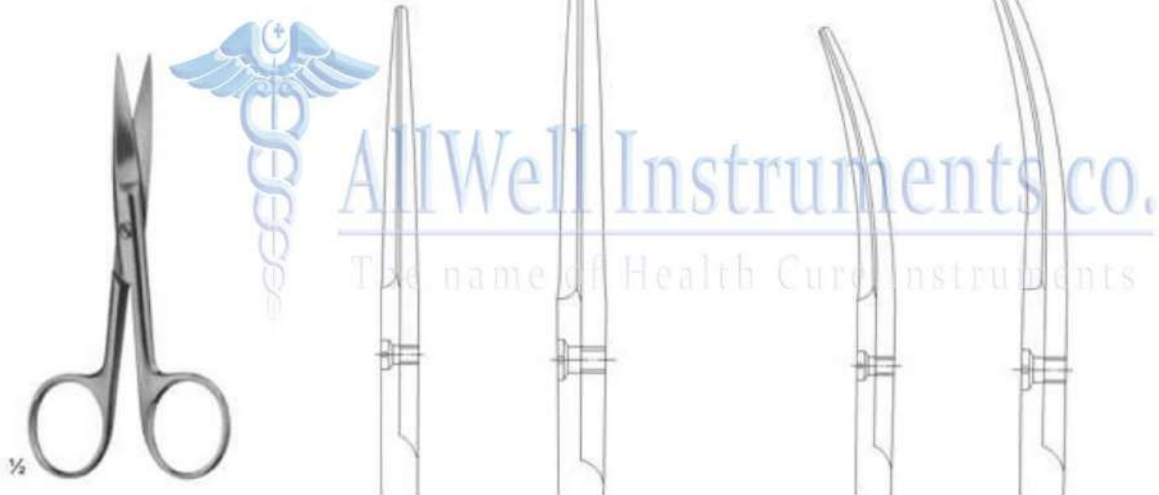

**02-3096 - 02-3102A**  
 Standard Types  
**02-3096** ( 115 mm )  
**02-3097** ( 130 mm )  
**02-3098** ( 145 mm )  
**02-3099** ( 150 mm )  
**02-3100** ( 165 mm )  
**02-3100A** ( 115 mm )  
**02-3101** ( 130 mm )  
**02-3101A** ( 145 mm )  
**02-3102** ( 150 mm )  
**02-3102A** ( 165 mm )

**02-3096** Size: 115 mm  
**02-3100** Size: 165 mm

**02-3100A** Size: 115 mm  
**02-3102A** Size: 165 mm

# Surgical Scissors

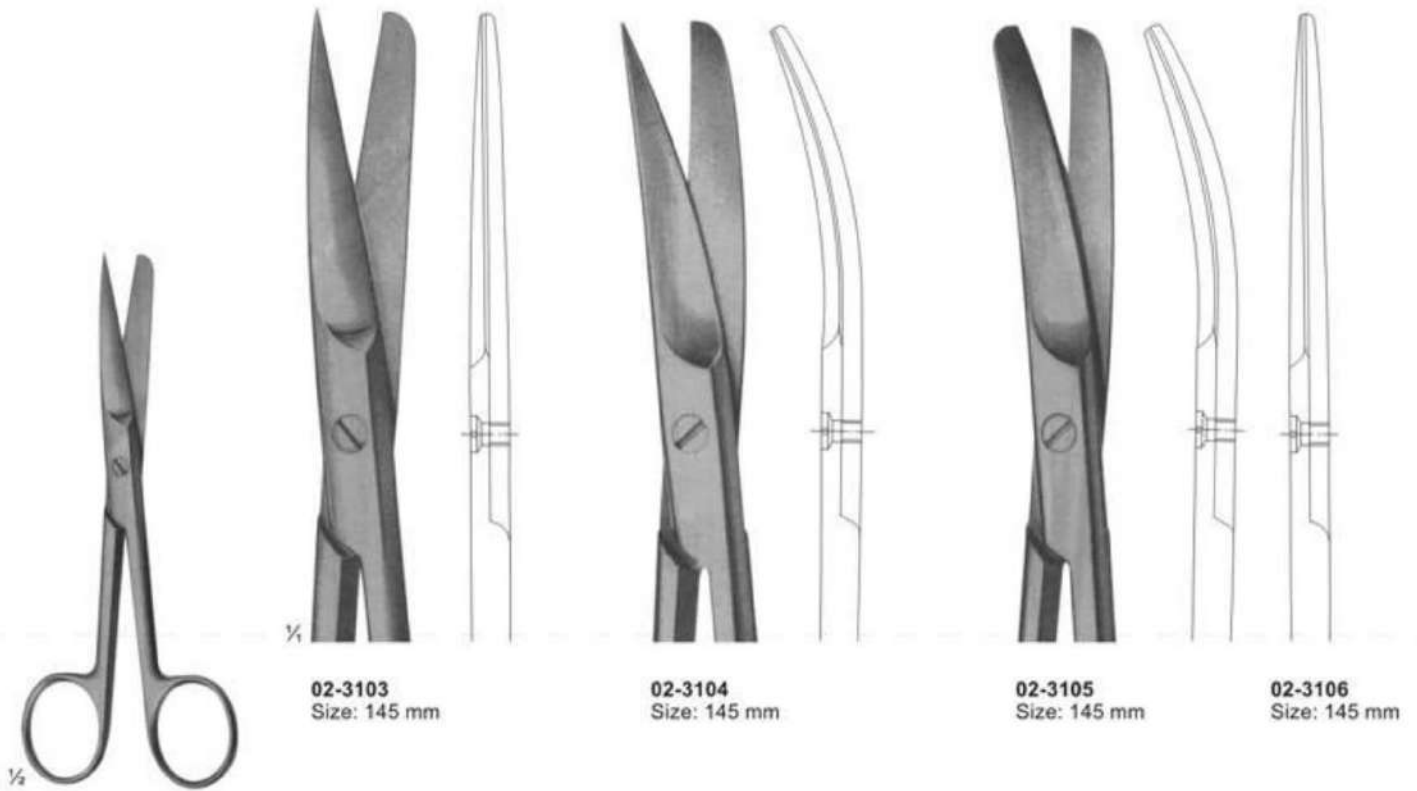

**02-3103 - 02-3106**  
DEAVER  
With flat lock

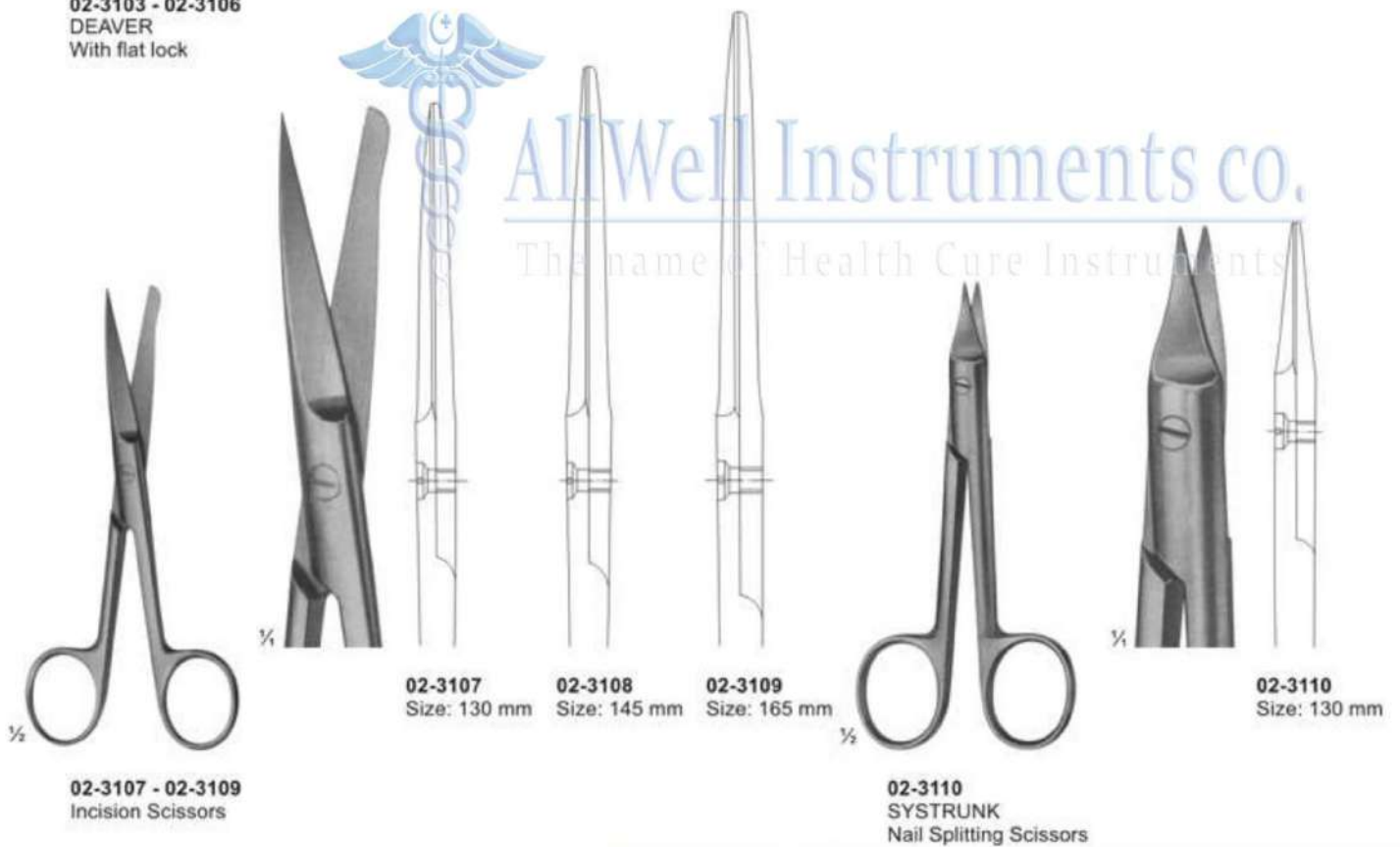

**02-3107 - 02-3109**  
Incision Scissors

**02-3110**  
SYSTRUNK  
Nail Splitting Scissors



# Dissecting Scissors

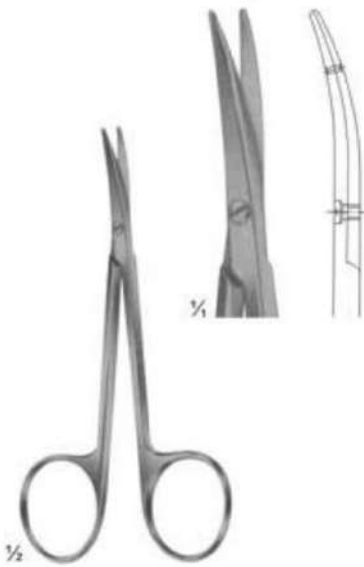

**02-3111**  
**LITTLER**  
Dissecting Scissors  
Tips with eye for suture  
Size: 115 mm

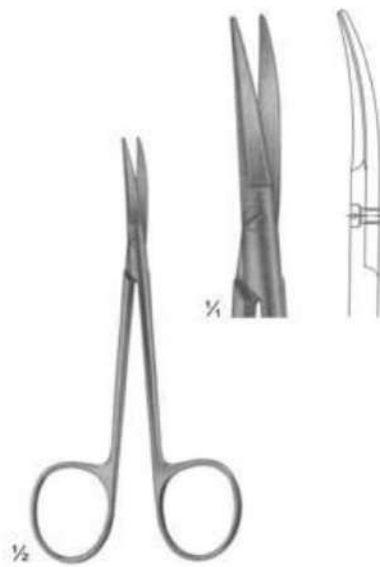

**02-3112**  
**COTTLE**  
Bulldog Scissors  
Size: 115 mm



**02-3113 - 02-3114**  
**STEVENS**  
Vessel and tendon Scissors  
Size: 100 mm

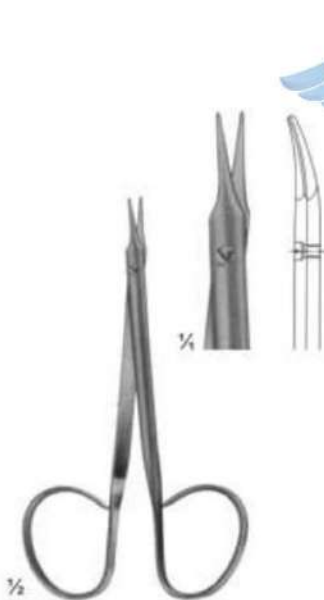

**02-3115**  
**STEVENS**  
Fine Dissecting Scissors  
Size: 110 mm



**02-3116 - 02-3119**  
**STEVENS**  
Vessel and tendon Scissors  
Size: 110 mm



**02-3116**  
Sharp



**02-3117**  
Sharp



**02-3118**  
Blunt

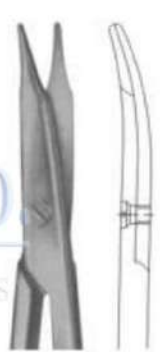

**02-3119**  
Blunt

# Dissecting Scissors

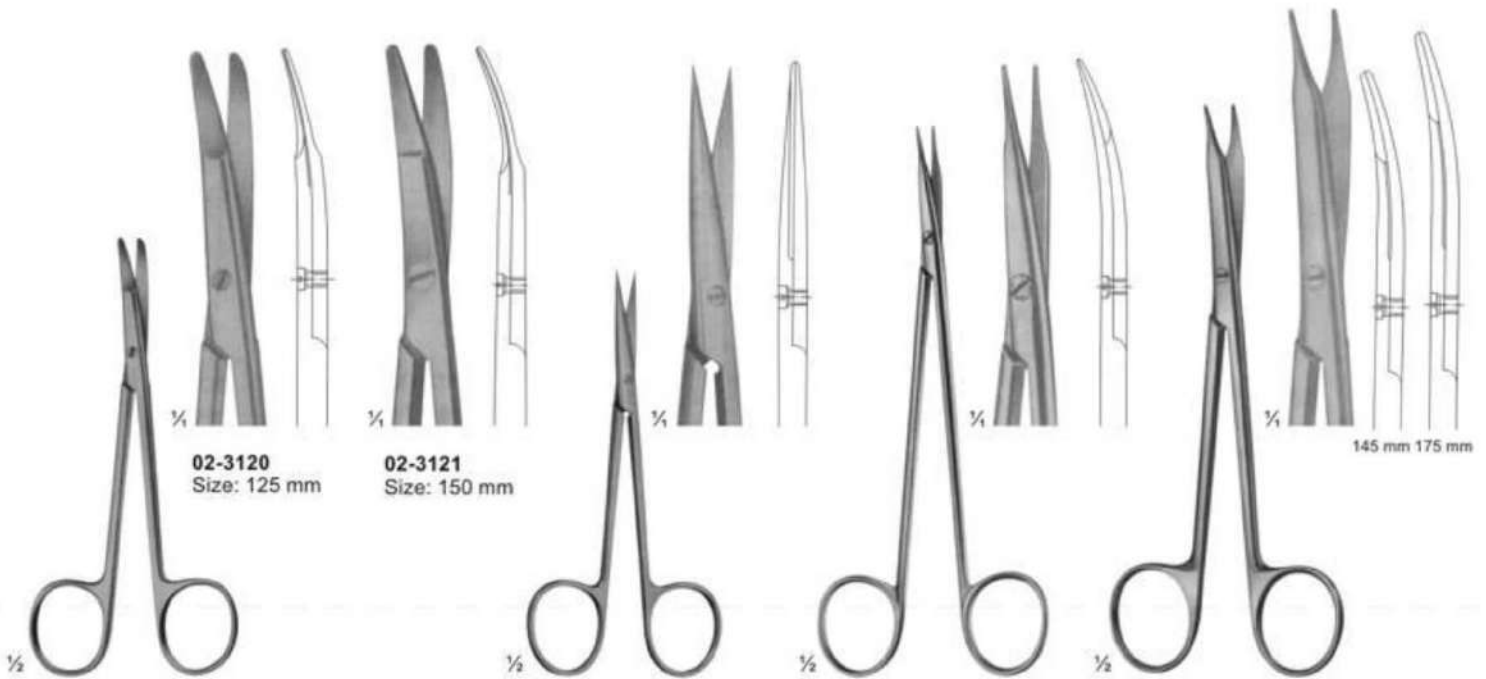

**02-3120 - 02-3121**  
**KILNER**  
Special flat points for dissecting and undermining the skin

**02-3122**  
**KILNER**  
Fine dissecting scissors  
Size: 115 mm

**02-3123**  
**JAMESON**  
Dissecting scissors  
Size: 150 mm

**02-3124**  
**REYNOLDS**  
Dissecting scissors



**02-3125**  
**DE BAKEY**  
Ateriotomy scissors  
Size: 175 mm

**02-3126 - 02-3127**  
**TOENNIS - ADSON**  
Dissecting scissors  
Size: 175 mm

**02-3128 - 02-3130**  
**TOENNIS**  
Dissecting scissors  
Size: 180 mm

**02-3126**  
Very delicate

**02-3127**  
Delicate

**02-3128**  
Very delicate

**02-3129**  
Delicate

**02-3130**  
Delicate

## Dissecting & Surgical Scissors



**02-3131 - 02-3132**  
**FOMON**  
 Lower lateral scissors

**02-3133 - 02-3134**  
**LANDOLT**  
 Enucleation scissors  
 Size: 120 mm

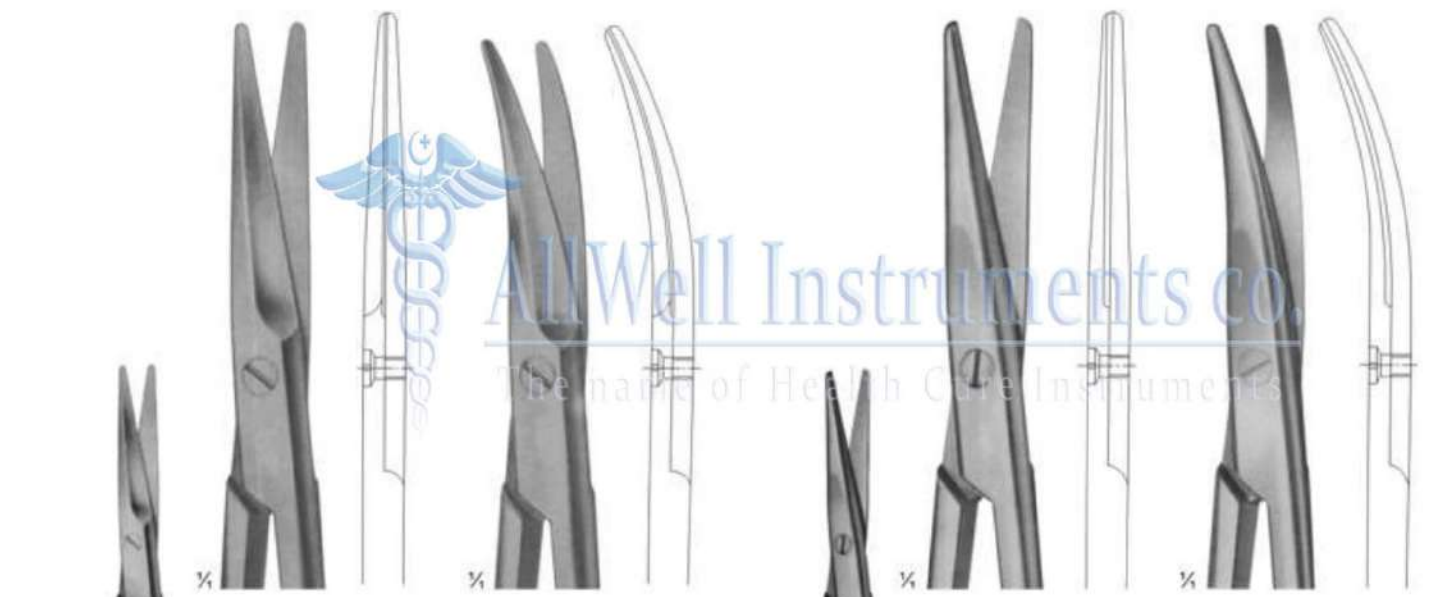

**02-3135 - 02-3137**

**02-3138 - 02-3140**  
**MAYO(curved)**  
**02-3138 (140 mm)**  
**02-3139 (155 mm)**  
**02-3140 (170 mm)**

**02-3141 - 02-3142**

**02-3143 - 02-3144**  
**MAYO-STILLE(curved)**  
**02-3143 (140 mm)**  
**02-3144 (170 mm)**

**02-3135 - 02-3137**  
**MAYO(straight)**  
**02-3135 (140 mm)**  
**02-3136(155 mm)**  
**02-3137 (170 mm)**

**02-3141 - 02-3142**  
**MAYO-STILLE(straight)**  
**02-3141 (140 mm)**  
**02-3142 (170 mm)**



# Dissecting Scissors

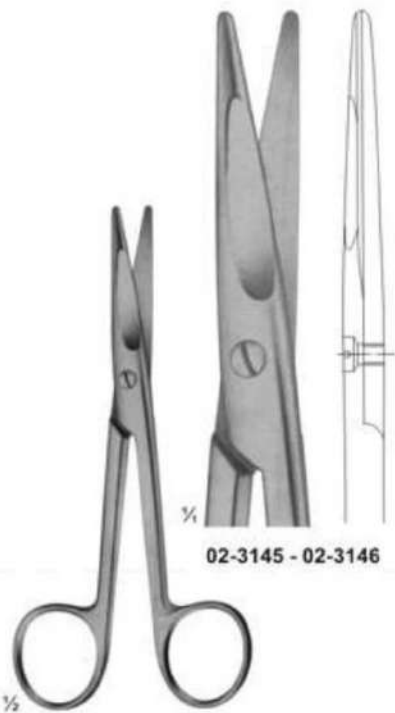

02-3145 - 02-3146

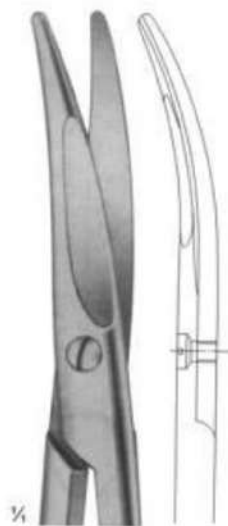

**MAYO-STILLE**  
02-3147 - 02-3148  
02-3147 (14cm)  
02-3148 (17cm)

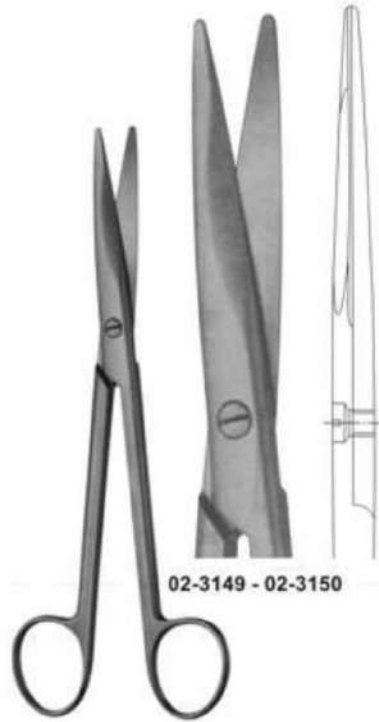

02-3149 - 02-3150

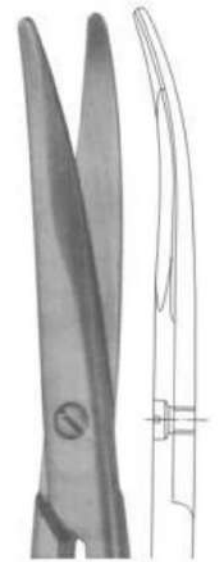

**MAYO**  
02-3151  
Size: 190 mm  
02-3152  
Size: 215 mm

02-3145 - 02-3146  
**MAYO-STILLE**  
With chamfered blades  
02-3145 (140 mm)  
02-3146 (170 mm)

**MAYO**  
With chamfered blades  
02-3149 (190 mm)  
02-3150 (215 mm)



02-3153  
Size: 170 mm

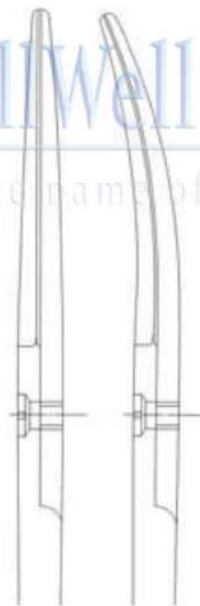

02-3154  
Size: 170 mm



02-3155 - 02-3156  
**MAYO-HARRINGTON**



02-3155  
Size: 230 mm



02-3156  
Size: 230 mm

02-3153 - 02-3154  
**MAYO-NOBLE (Broad pattern)**

# Dissecting Scissors



1/2  
02-3157 - 02-3158  
STILLE

1/4  
02-3157  
Size: 150 mm

1/4  
02-3158  
Size: 150 mm

1/2  
02-3159 - 02-3160  
LEXER  
Narrow

1/4  
02-3159  
Size: 165 mm

1/4  
02-3160  
Size: 165 mm

1/2  
02-3161  
MAYO-LEXER  
Standard

1/4  
Size: 165 mm

1/2  
02-3162 - 02-3163  
MAYO  
02-3162 (165 mm)  
02-3163 (200 mm)

1/4  
02-3162

02-3163

1/4  
MAYO  
02-3164  
Size: 165 mm  
02-3165  
Size: 200 mm  
02-3166  
Size: 210 mm

# Dissecting Scissors

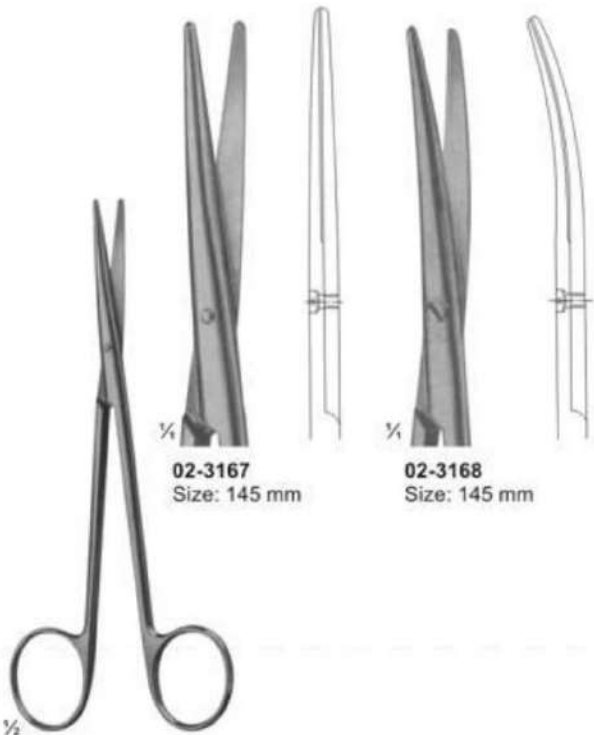

**02-3167**  
Size: 145 mm

**02-3168**  
Size: 145 mm

**02-3167 - 02-3168**  
BABY - METZENBAUM

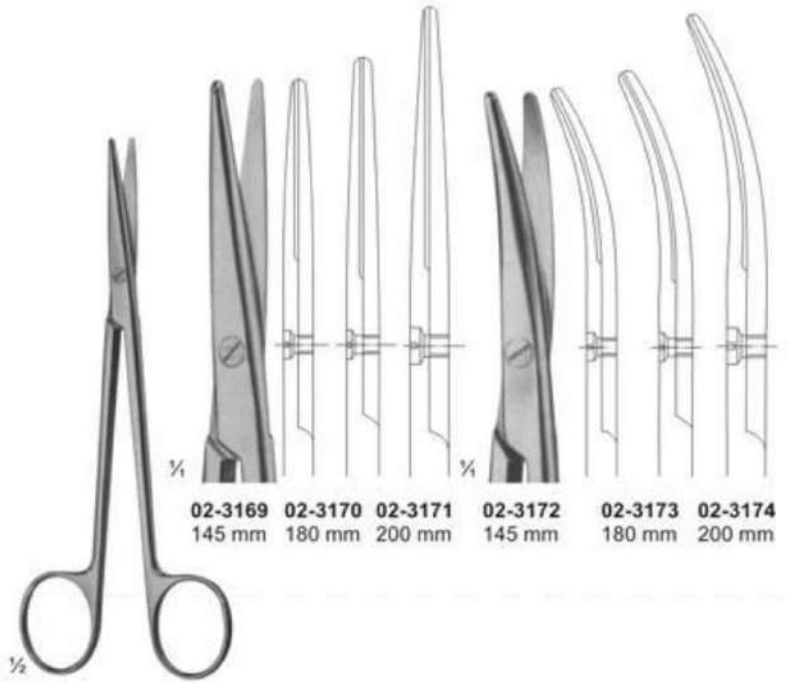

**02-3169**  
145 mm

**02-3170**  
180 mm

**02-3171**  
200 mm

**02-3172**  
145 mm

**02-3173**  
180 mm

**02-3174**  
200 mm

**02-3169 - 02-3174**  
METZENBAUM



**02-3175 - 02-3182**  
NELSON  
METZENBAUM

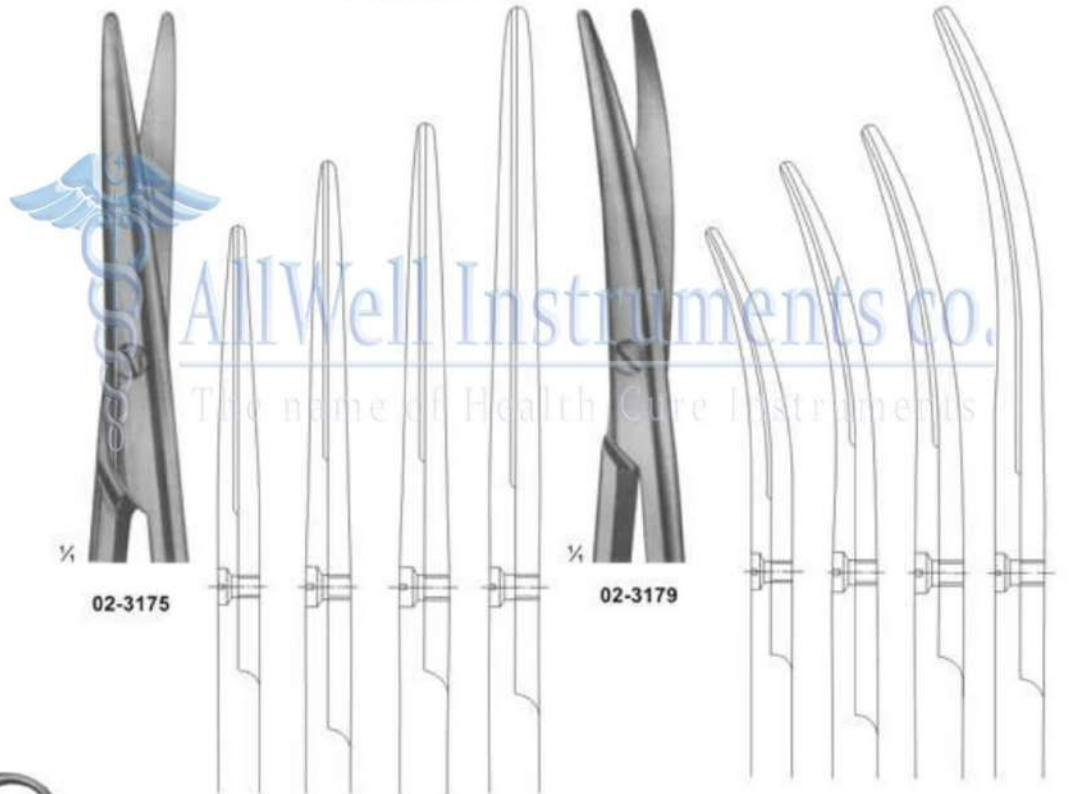

**02-3175**

**02-3179**

**02-3175** 230 mm   **02-3176** 250 mm   **02-3177** 280 mm   **02-3178** 305 mm

**02-3179** 230 mm   **02-3180** 250 mm   **02-3181** 280 mm   **02-3182** 305 mm



# Vessel Scissors

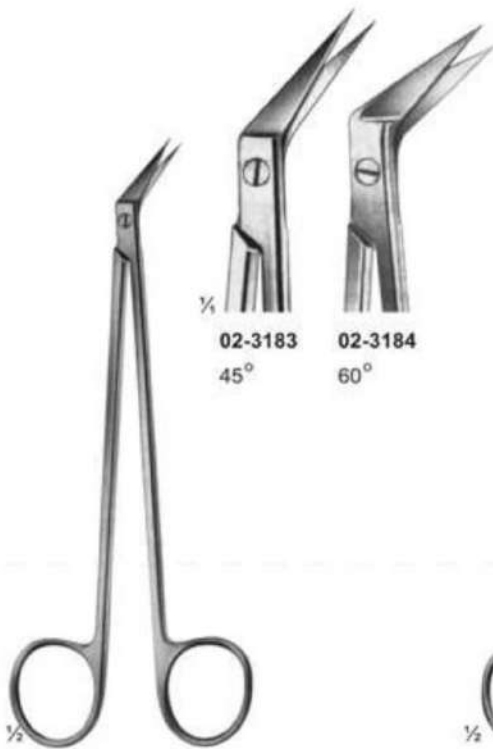

02-3183  
45°  
02-3184  
60°

02-3183 - 02-3184  
DE BAKKEY  
Size: 155 mm

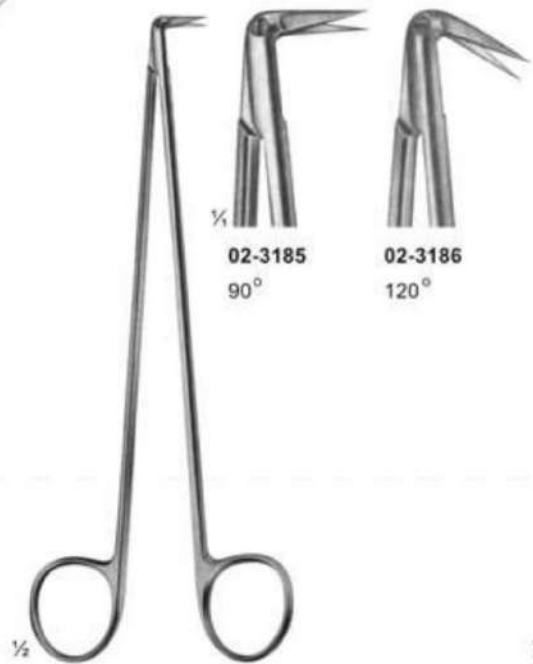

02-3185  
90°  
02-3186  
120°

02-3185 - 02-3186  
DIETRICH  
Size: 170 mm

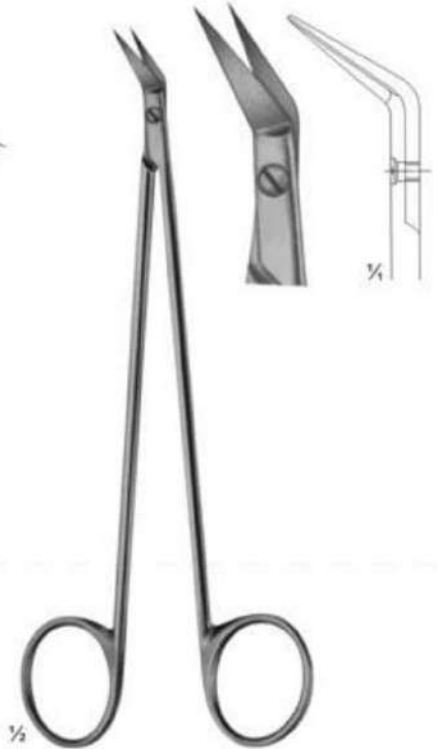

02-3187  
POTTS-SMITH  
Size: 180 mm  
55° Angled on Flat

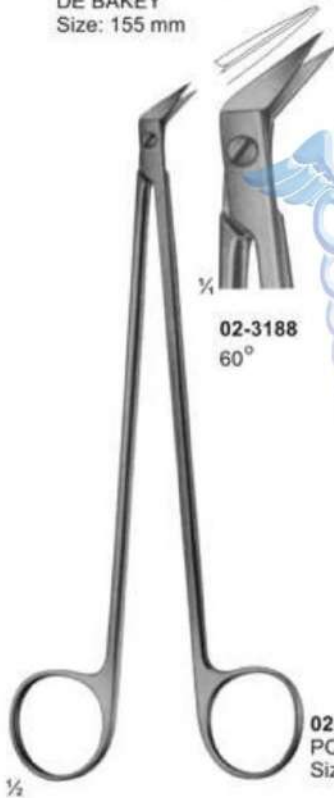

02-3188  
60°

02-3188  
POTTS-SMITH  
Size: 180 mm



02-3189  
45° Offset Scissors  
S-Shaped

02-3189  
DEBAKEY  
Size: 155 mm



02-3190  
55°

02-3190  
FAVOLORO  
Coronary Artery  
Scissors  
Size: 140 mm

## Cardiovascular and Neuro-Surgery Scissors



**02-3191**  
**OLIVECRONA**  
Dura Scissors



**02-3192**  
**STRULLY**  
Pointed  
Size: 220 mm

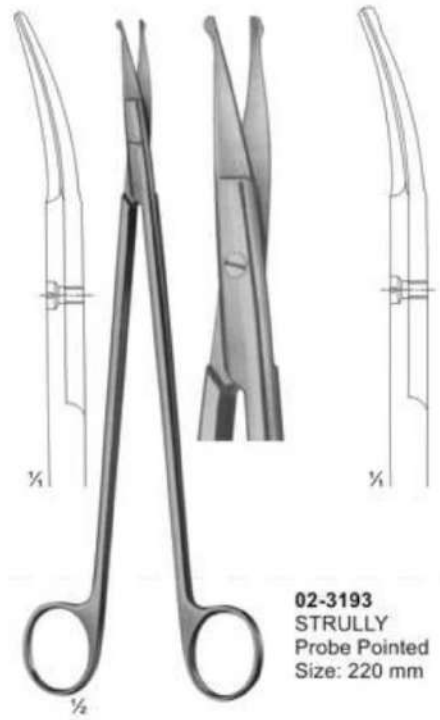

**02-3193**  
**STRULLY**  
Probe Pointed  
Size: 220 mm

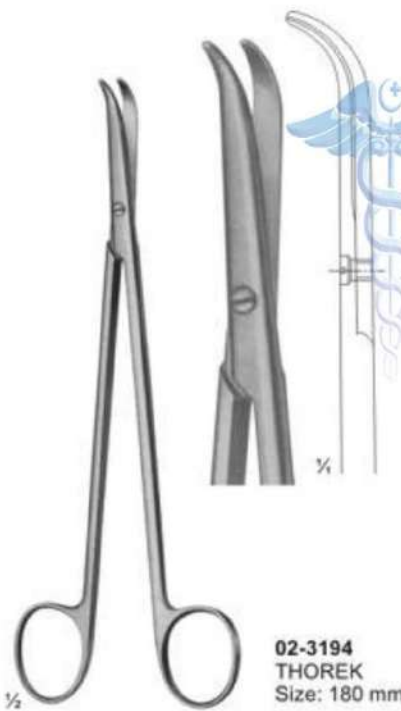

**02-3194**  
**THOREK**  
Size: 180 mm



**02-3195**  
**POTTS-SMITH**  
Size: 190 mm



**02-3196**  
**SATINSKY**  
Size: 245 mm

## Delicate, Nasal and Tonsil Scissors



**02-3197**  
1 Finely Toothed Blade  
Size: 130 mm

**02-3198**  
LOCKLIN  
Curved Sideways,  
1 Toothed Blade  
Size: 155 mm

**02-3199**  
FOMON  
Blades Serrated  
Size: 145 mm

**02-3200**  
COTTLE  
Size: 165 mm



**02-3201**  
HEYMANN-KNIGHT  
Size: 175 mm

**02-3202**  
DEAN  
Blades Serrated  
Size: 170 mm

**02-3203**  
GOOD  
Size: 195 mm



# Bone Shears



**02-3204**  
KILLIAN  
Size: 200 mm



**02-3205 - 02-3206**



**AllWell Instruments co.**  
The name of Health Care Instruments



**02-3205**  
195 mm



¼



**02-3206**  
225 mm



¼

# Operating and Gynaecology Scissors

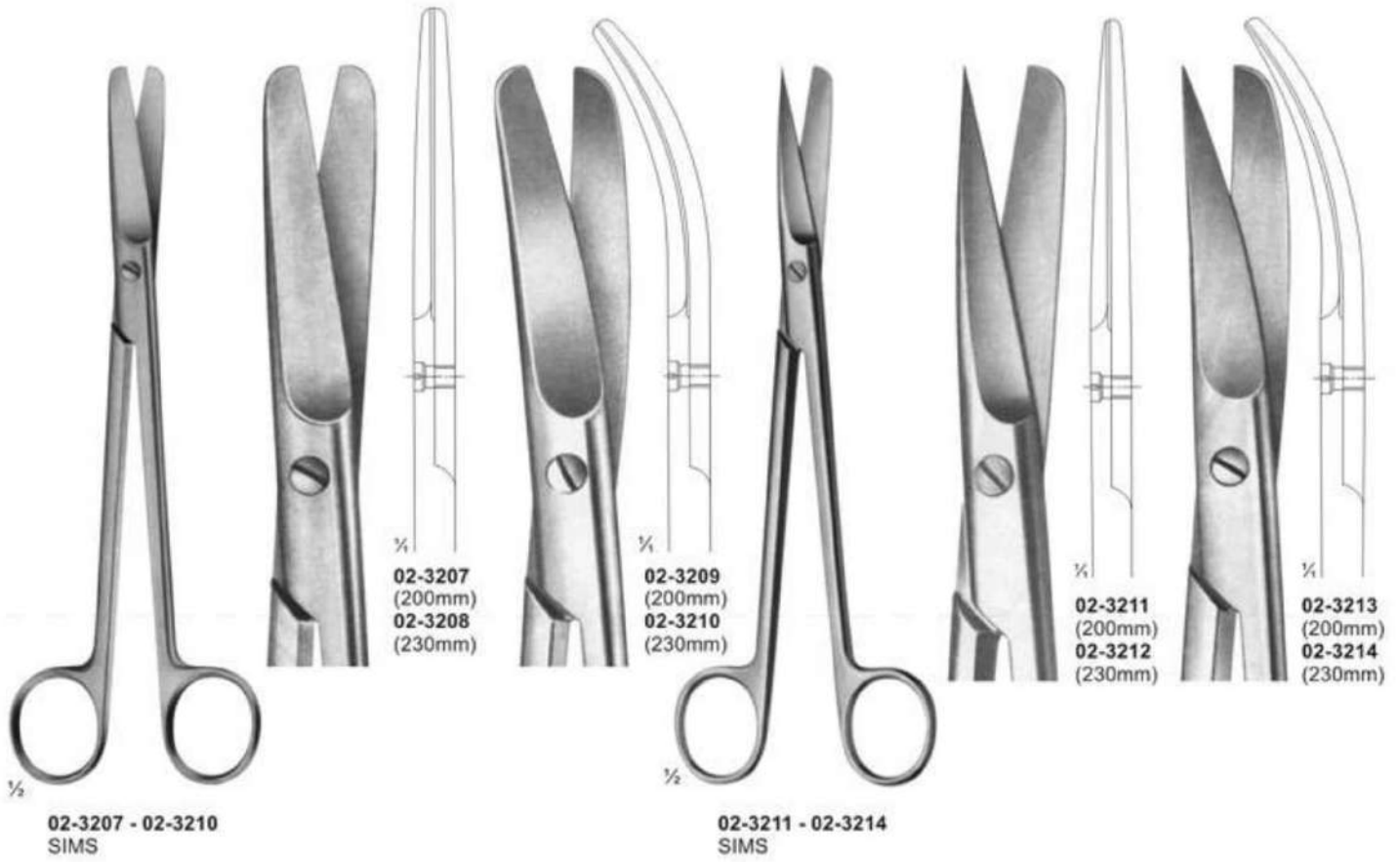

## Operating and Gynaecology Scissors



**02-3220**  
**SIEBOLD**  
 Uterine Scissors  
 Size: 245 mm

**02-3221**  
**BOZEMANN**  
 Uterine Scissors  
 Size: 220 mm

**02-3222**  
**SIMS-SIEBOLD**  
 Uterine Scissors  
 Size: 250 mm



## Scissors For Obstetrics



**02-3223**  
**SCHUMACHER**  
Umbilical Cord Scissors  
Size: 155 mm



**02-3224**  
Umbilical Cord Scissors  
Size: 105 mm

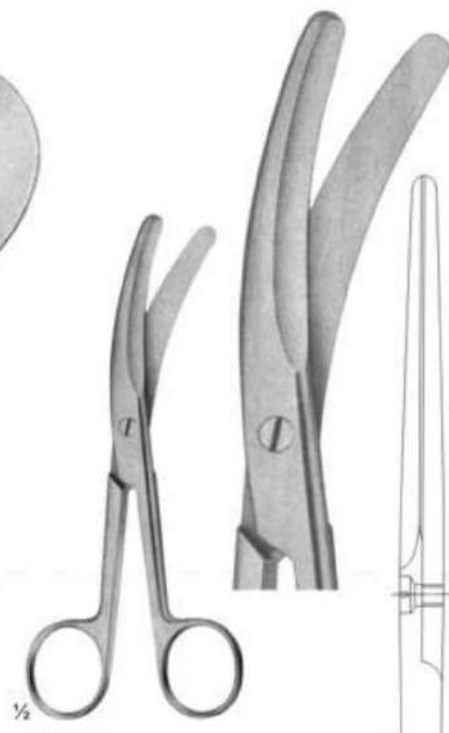

**02-3225**  
Umbilical Cord Scissors



135 mm

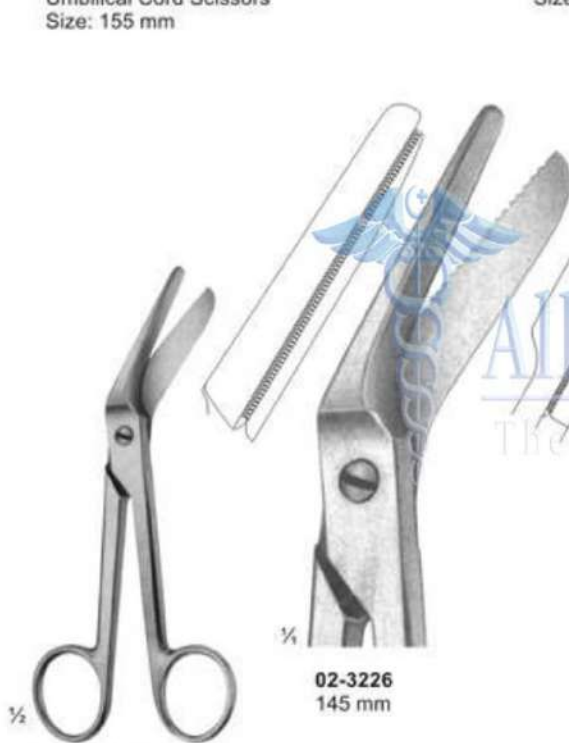

**02-3226 - 02-3227**  
**BRAUN-STADLER**  
Episiotomy Scissors

**02-3226**  
145 mm

**02-3227**  
200 mm



**02-3228**  
Episiotomy Scissors  
240 mm



## Bowel Scissors, Rectal Scissors



**02-3229**  
Bowel Scissors  
Size: 210 mm

**02-3230**  
Bowel Scissors  
Size: 210 mm

**02-3231**  
LLOYD-DAVIES  
(GOLIGHER'S)  
Rectal Scissors  
Size: 270 mm

**02-3232**  
STELZNER  
Rectal Scissors  
Size: 310 mm

# Ligature Scissors



**02-3233 - 02-3234**  
SPENCER



**02-3235**  
LITTAUER  
Size: 135 mm

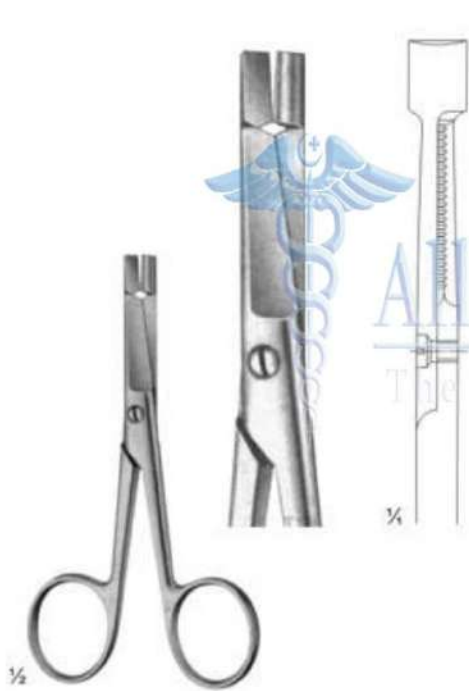

**02-3236**  
EISELSBERG  
Size: 115 mm



**02-3237**  
SCHOEMAKER-LOTH  
Size: 125 mm



## Wire and Plate Scissors

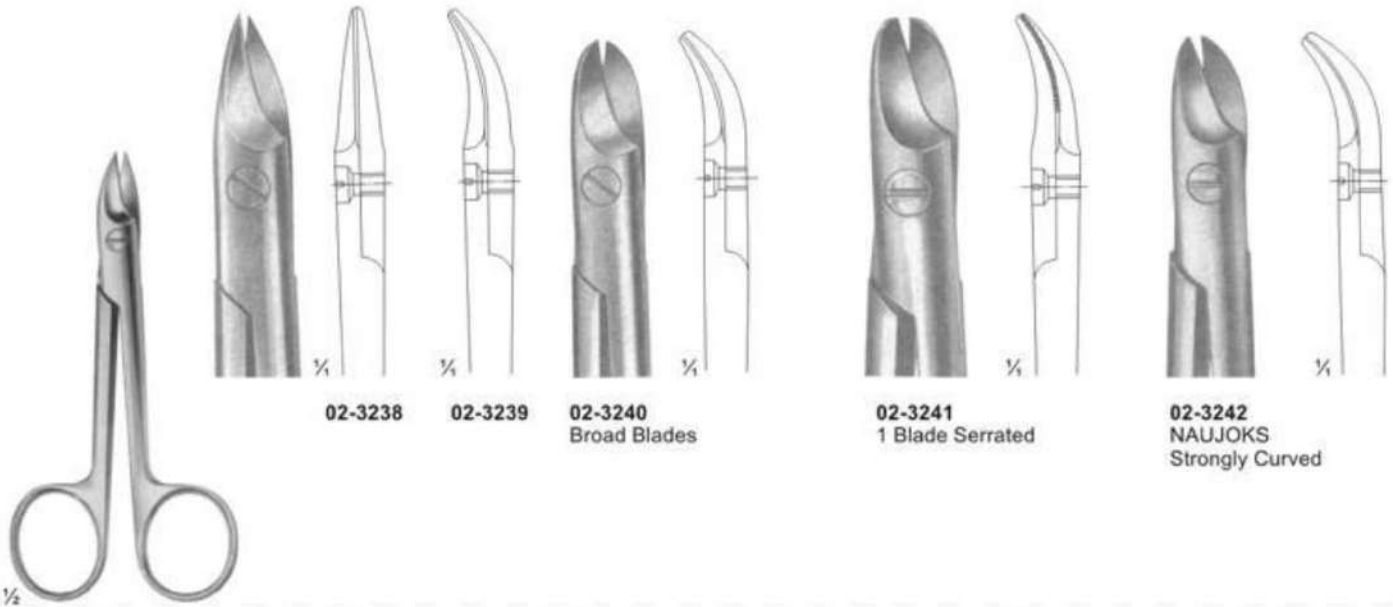

02-3238

02-3239

02-3240  
Broad Blades

02-3241  
1 Blade Serrated

02-3242  
NAUJOKS  
Strongly Curved

02-3238 - 02-3242  
BEEBE  
Size: 110 mm

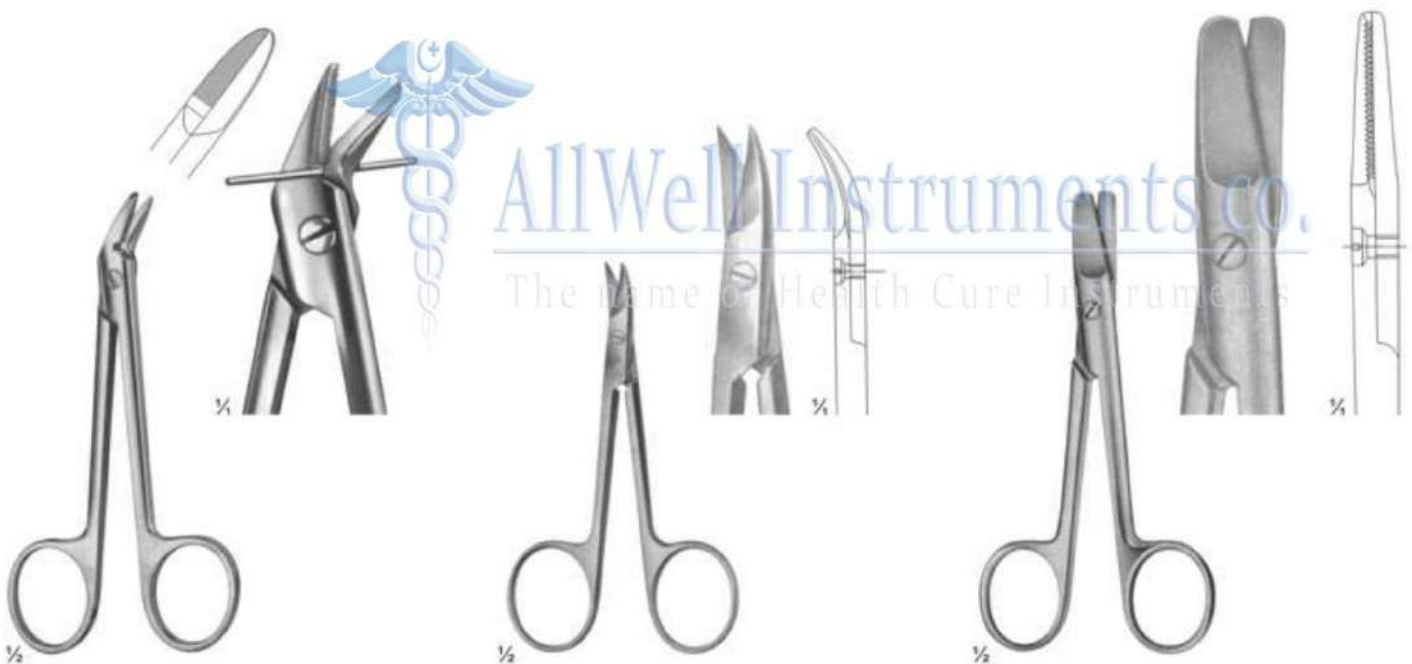

02-3243  
1 Blade Serrated  
Size: 120 mm

02-3244  
STRACK  
Size: 100 mm

02-3245  
HARVEY  
blades serrated  
Size: 125 mm

## Nail and Bandage Scissors

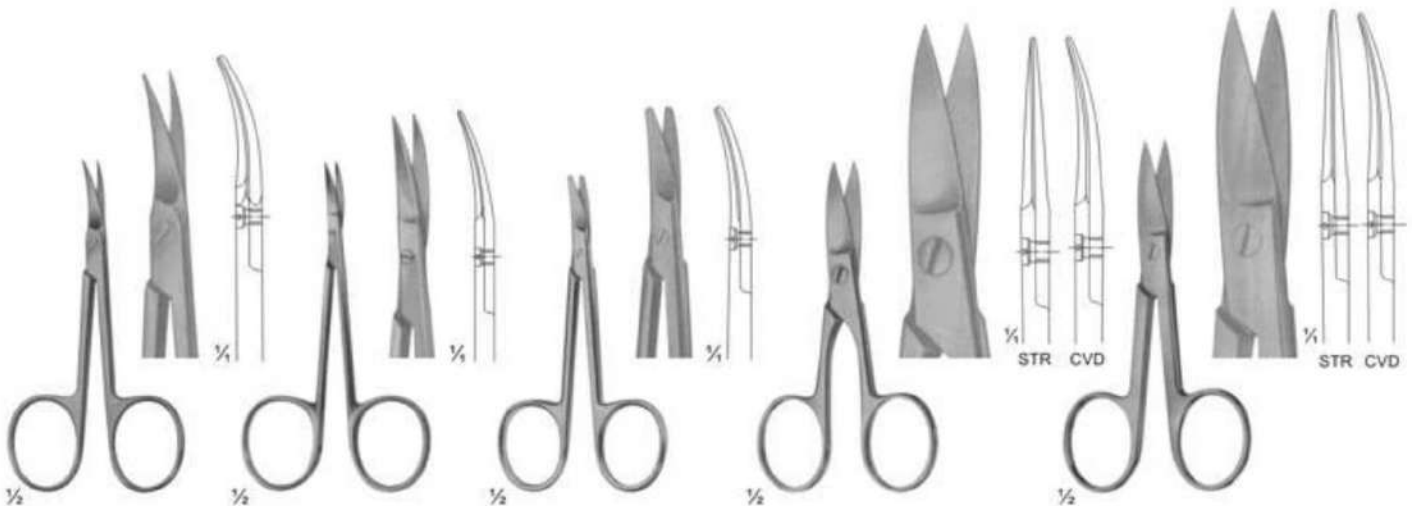

**02-3246**  
NAIL SCISSORS  
Size: 90 mm

**02-3247**  
NAIL SCISSORS  
especially fine pattern  
Size: 90 mm

**02-3248**  
BABY NAIL  
SCISSORS  
Size: 85 mm

**02-3249 - 02-3252**  
NAIL SCISSORS  
02-3249(90mm)straight  
02-3250(90mm)curved  
02-3251(100mm)straight  
02-3252(110mm)curved

**02-3253 - 02-3255**  
NAIL SCISSORS  
02-3253(95mm)straight  
02-3254(95mm)curved  
02-3255(105mm)straight



**02-3256**  
KNOWLES  
Size: 140 mm

**02-3257**  
KNOWLES  
Size: 145 mm

**02-3258**  
Size: 150 mm

**02-3259**  
SMITH  
Size: 180 mm

**02-3260**  
BANDAGE CUTTING  
SCISSORS  
Size: 310 mm

## Bandage and Cloth Scissors



1/2  
**02-3261**  
UNIVERSAL BANDAGE & CLOTH SCISSORS,  
WITH TOOTHED EDGES, AUTO CLEAVABLE up to 143 °c  
180 mm



1/2  
**02-3262**  
LISTER BANDAGE & CLOTH  
SCISSORS, WITH TOOTHED EDGES,  
AUTO CLEAVABLE up to 143 °c  
Size: 145 mm

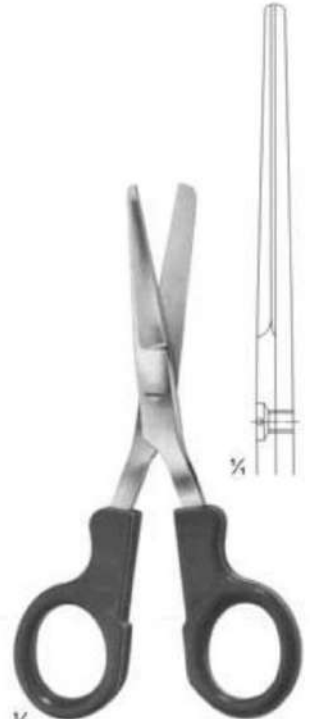

1/2  
**02-3263**  
NURSE'S SCISSORS  
Size: 145 mm  
AUTO CLEAVABLE up to 143 °c





## Bandage, Cloth and Plaster Scissors



**02-3270**  
CLOTH SCISSORS  
205 mm



**02-3271**  
BRAUN-STADLER  
Bandage scissors  
225 mm



**02-3272**  
SEUTIN  
Plaster scissors  
230 mm



**02-3273 - 02-3274**  
ESMARCH (Plaster scissors)



**02-3275**  
BRUNS  
Plaster scissors  
235 mm



**02-3276**  
BANDAGE SCISSORS  
235 mm



AllWell Instruments co.  
The name of Health Care Instruments

# Micro Forceps, Jeweler Types and Micro Suture Tying Forceps

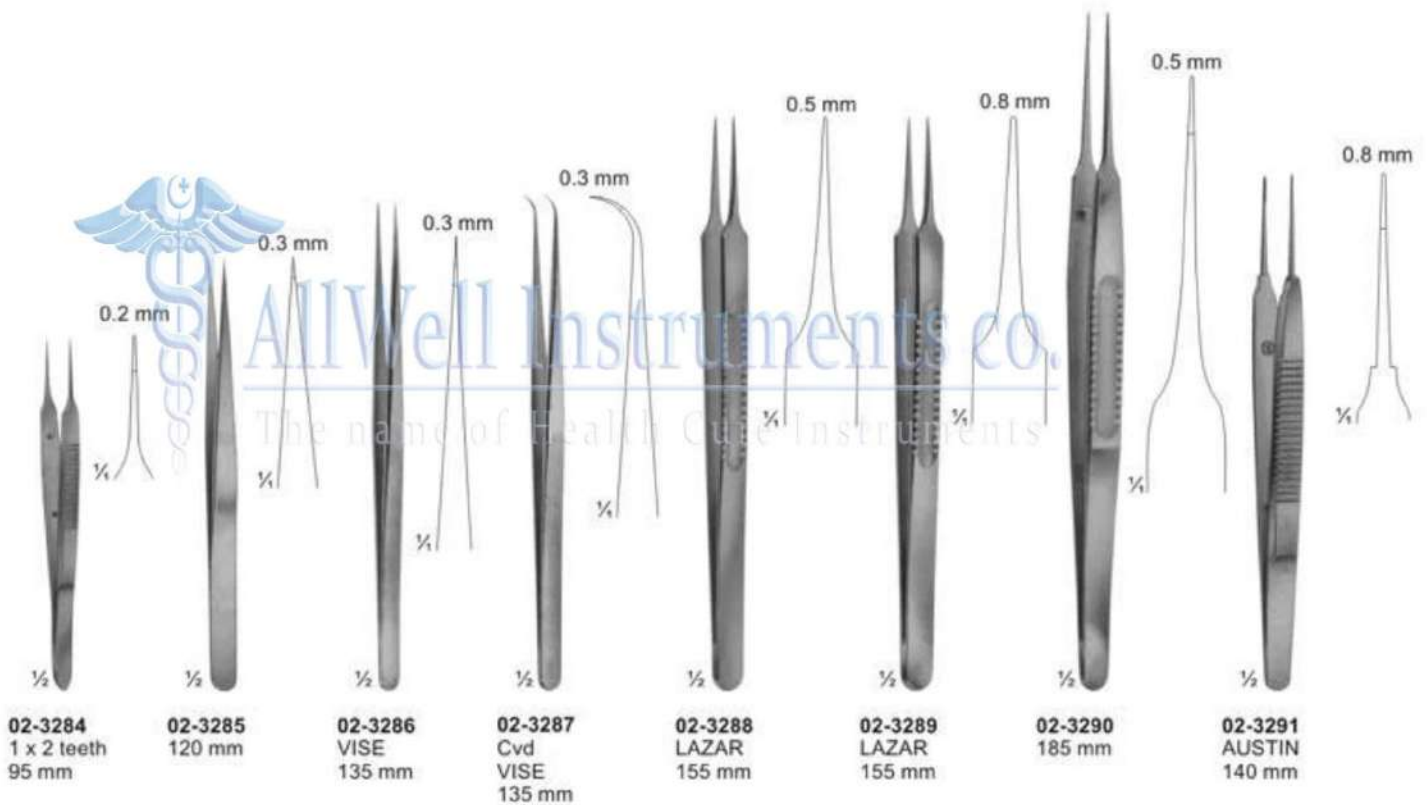
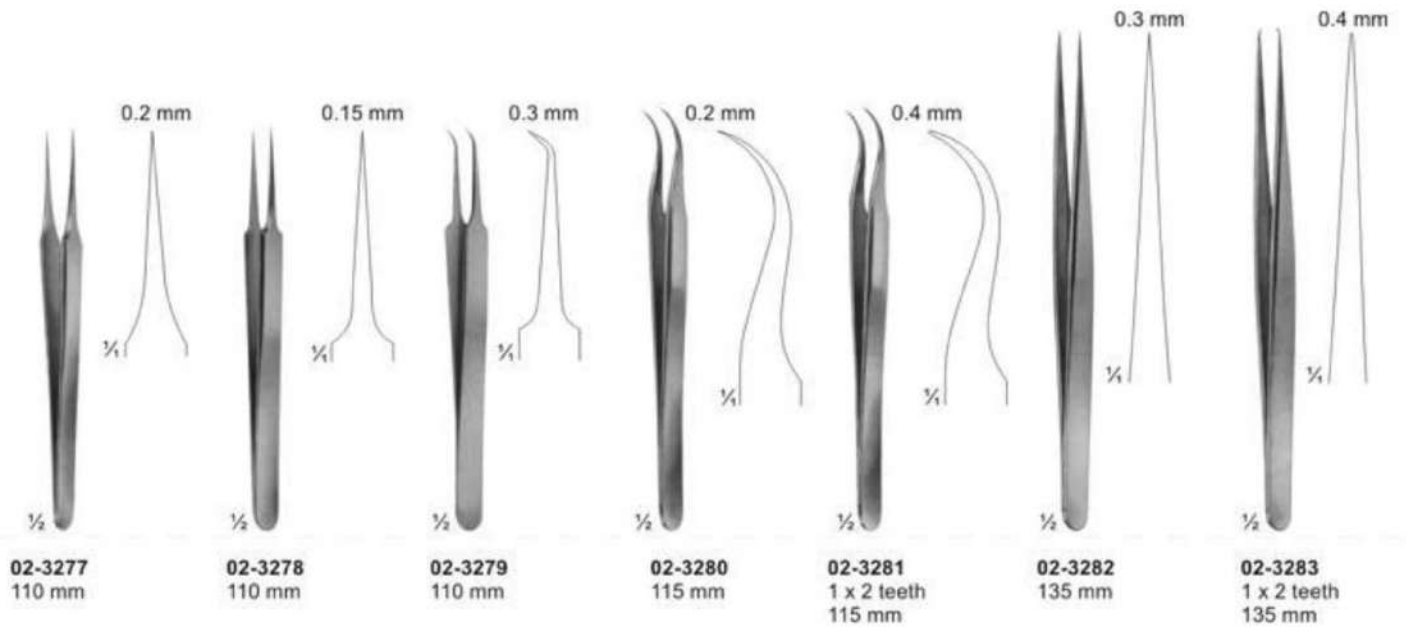

# Micro Forceps, Ligature Forceps (Light Patterns) Bayonet - Shaped

0.15 mm 0.20 mm 0.30 mm 0.50 mm

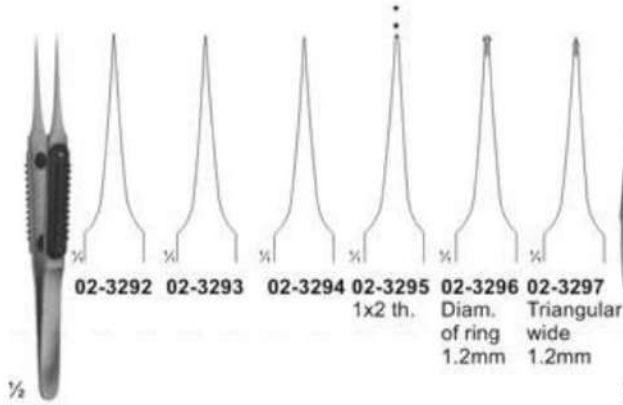

02-3292 02-3293 02-3294 02-3295 02-3296 02-3297  
1x2 th. Diam. Triangular  
of ring wide  
1.2mm 1.2mm

02-3292 - 02-3297  
MULLER  
110 mm



02-3298  
LIGATURE  
FORCEPS  
220 mm



02-3299  
YASARGIL  
Ligature forceps  
185 mm



02-3300 - 02-3302  
MICRO FORCEPS  
Ligature pattern  
185 mm

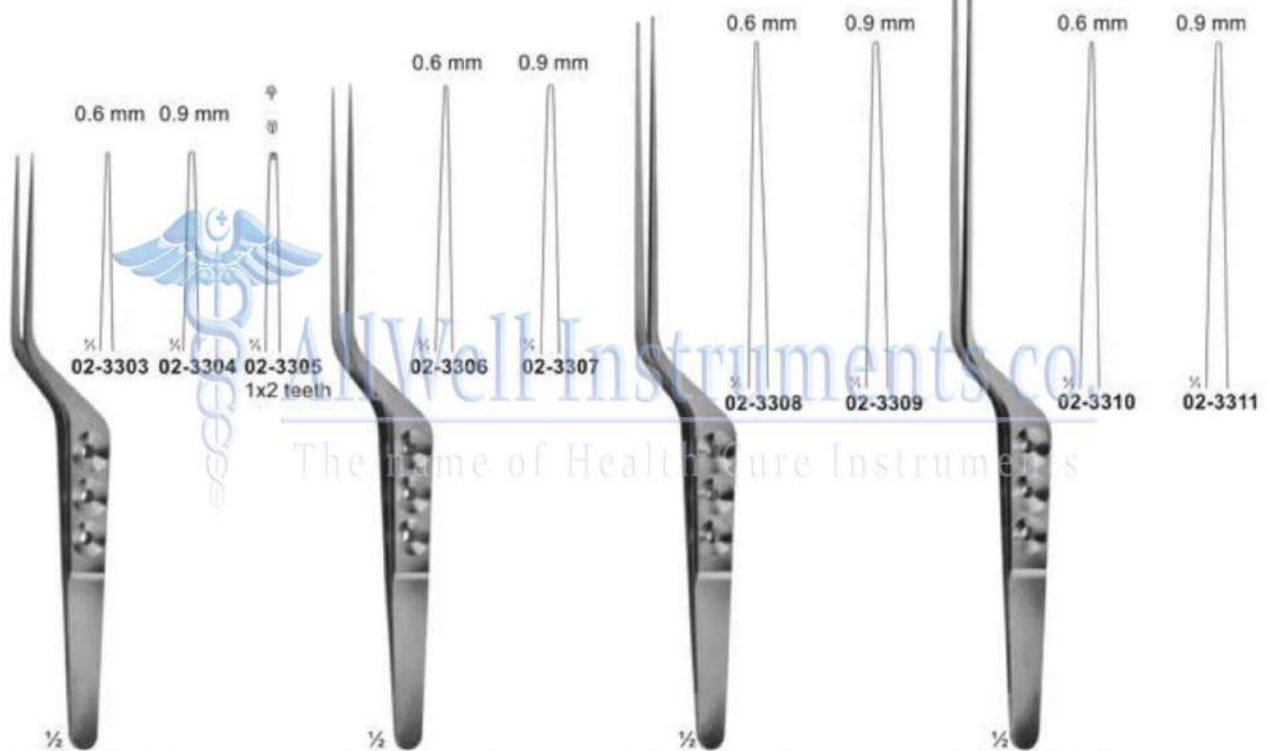

0.6 mm 0.9 mm  
02-3303 02-3304 02-3305  
1x2 teeth

02-3303 - 03-3305  
YASARGIL  
180 mm

0.6 mm 0.9 mm  
02-3306 02-3307

02-3306 - 02-3307  
YASARGIL  
200 mm

0.6 mm 0.9 mm  
02-3308 02-3309

02-3308 - 03-3309  
YASARGIL  
220 mm

0.6 mm 0.9 mm  
02-3310 02-3311

02-3310 - 02-3311  
YASARGIL  
240 mm



# Forceps for Grasping Tissue, Tumors, Bayonet Shaped



**02-3312 - 02-3314**  
YASARGIL-SAMII  
Jaws Spoon-Shaped  
240 mm



**02-3315 - 02-3316**  
YASARGIL  
Jaws Spoon-Shaped  
220 mm



**02-3317 - 02-3319**  
SAMII  
Jaws Spoon-Shaped  
230 mm



**02-3320 - 02-3322**  
SAMII  
Jaws Spoon-Shaped  
230 mm



**02-3323**  
HUNT  
Tumor-and  
Vessel Forceps  
200 mm



**02-3324**  
HUNT  
Tumor-and  
Vessel Forceps  
200 mm



**02-3325**  
YASARGIL  
Tumor-and  
Vessel Forceps  
200 mm

# Delicate Dissecting, Microscopic, Sterilizing Forceps

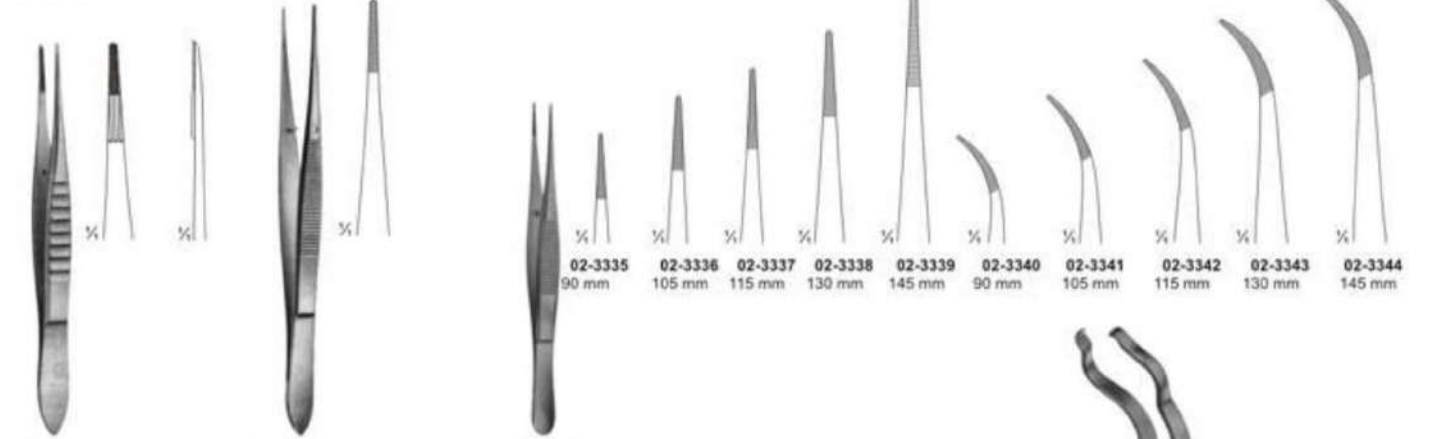
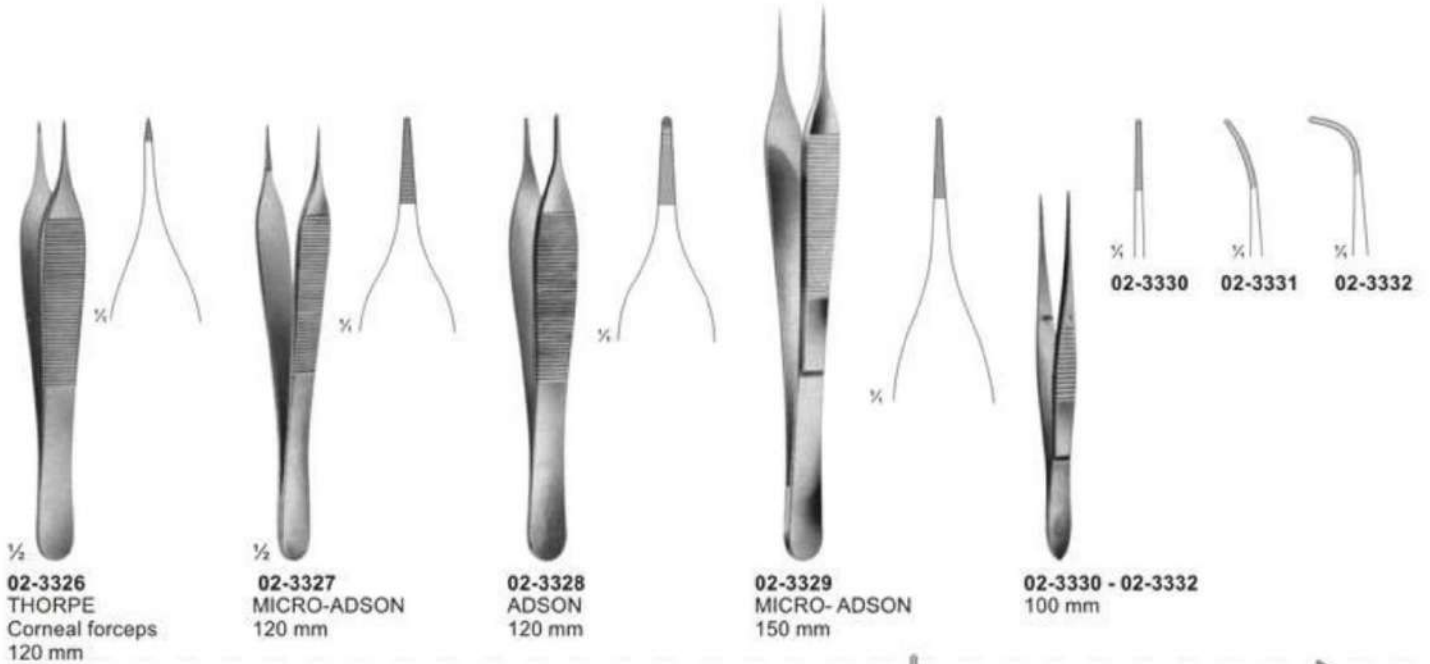

**AllWell Instruments co.**  
The name of Health Care Instruments

# Delicate Dissecting Forceps

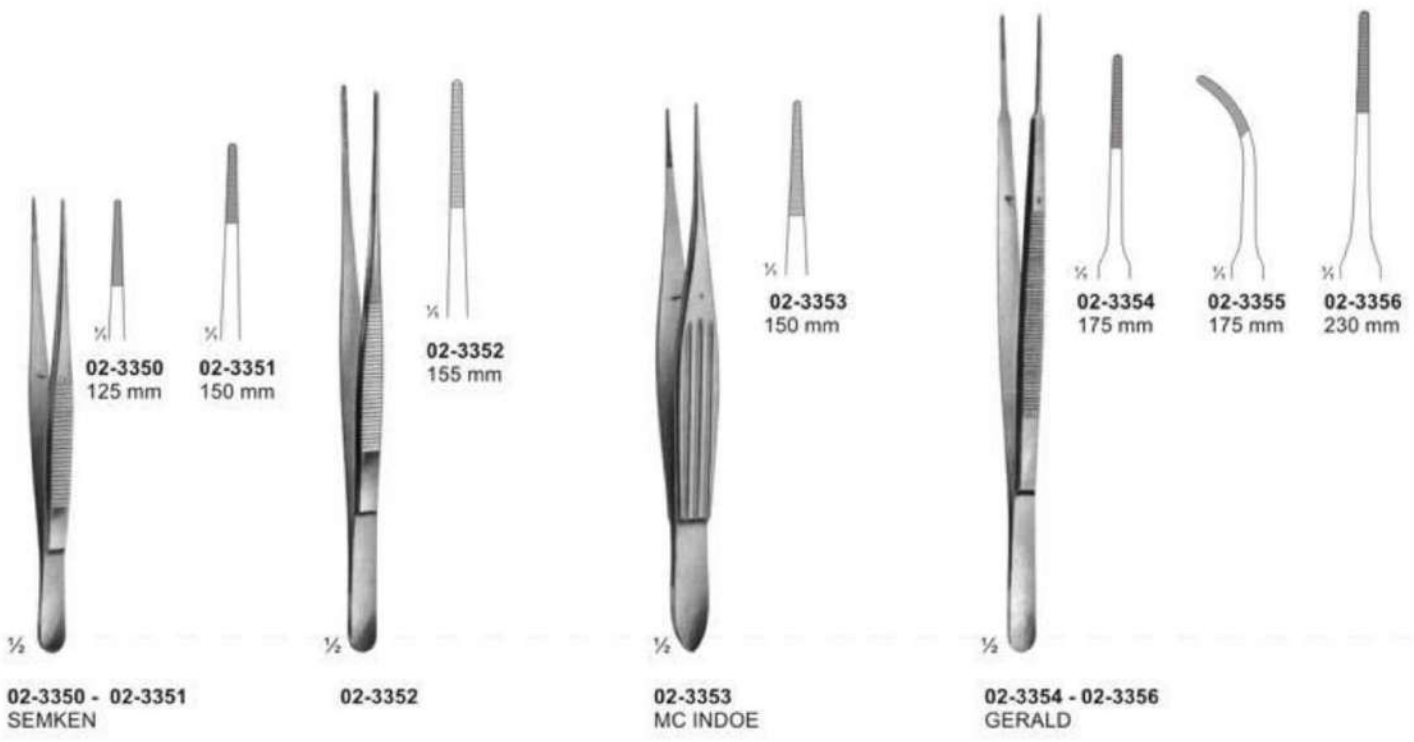



# Dissecting Forceps

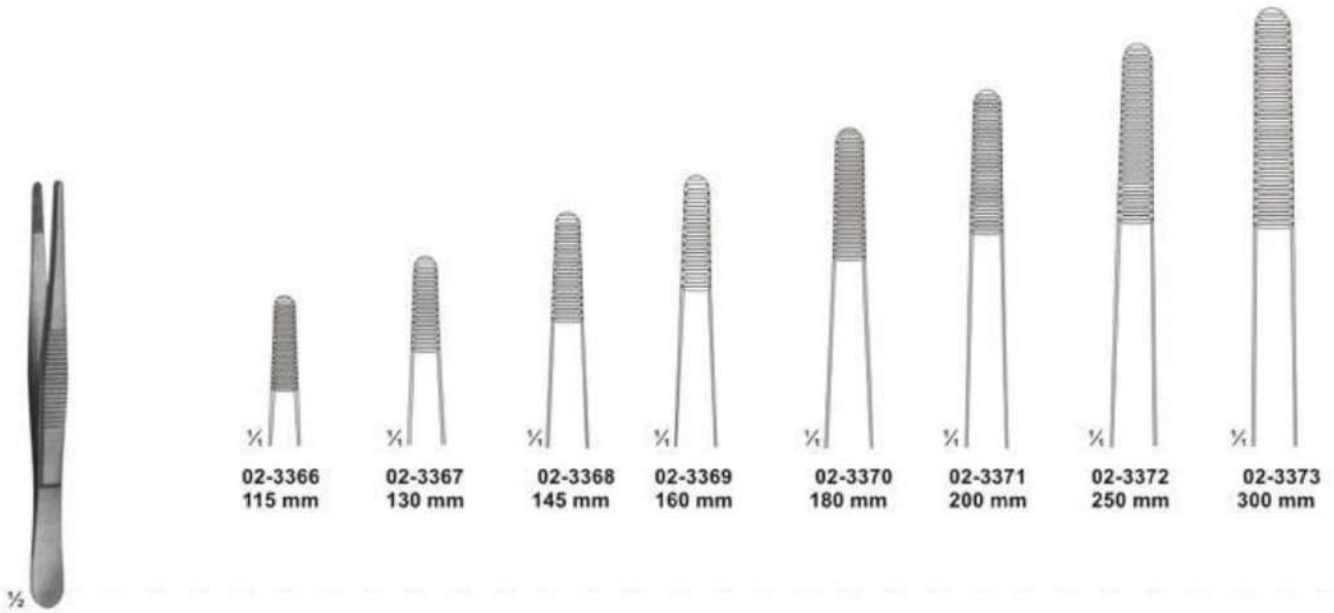

02-3366 - 03-3373  
STANDARD



02-3374 - 02-3378  
MEDIUM

02-3379 - 02-3380  
MEDIUM

# Dissecting Forceps

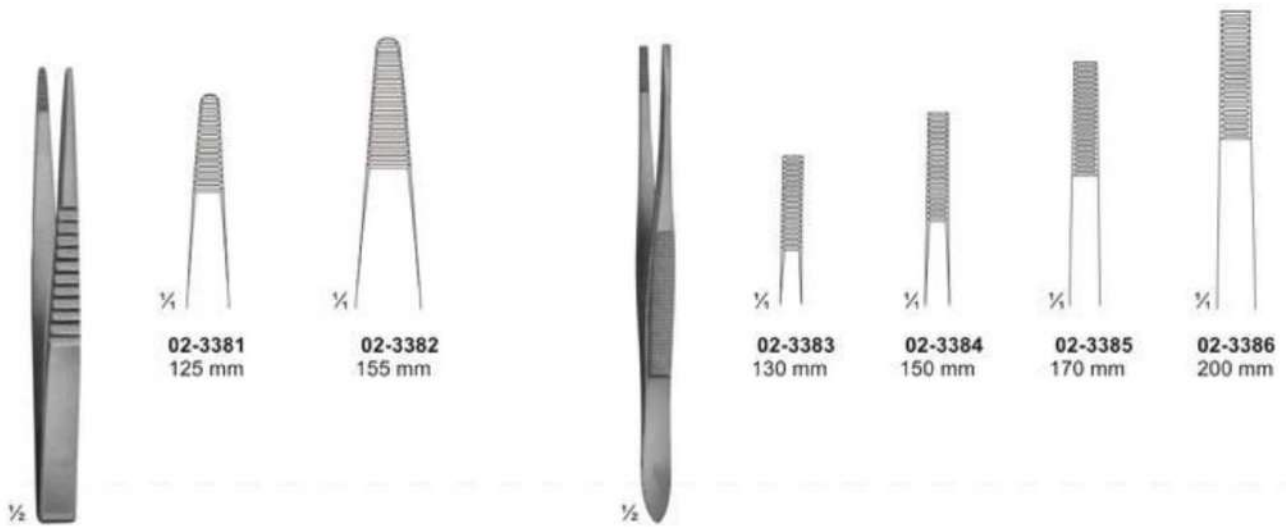

02-3381 - 02-3382

02-3383 - 02-3386  
Swedish pattern



02-3387  
OCHSNER  
Ligature forceps  
145mm

02-3388  
FRICKE  
Artery forceps  
130mm

03-3389  
BONNEY  
175mm

# Ultra-Light Forceps ATRAUMATA

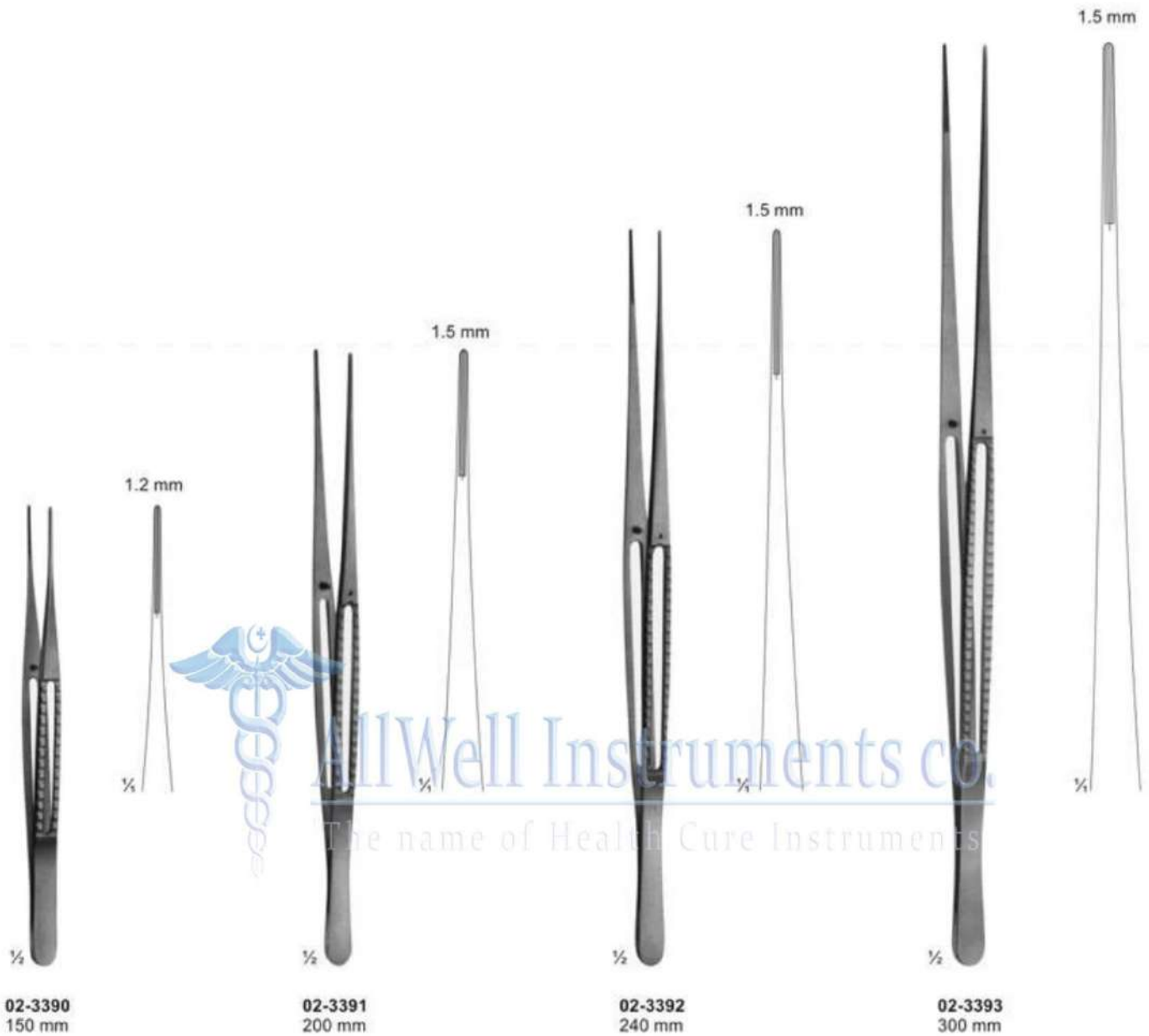



# Forceps ATRAUMATA

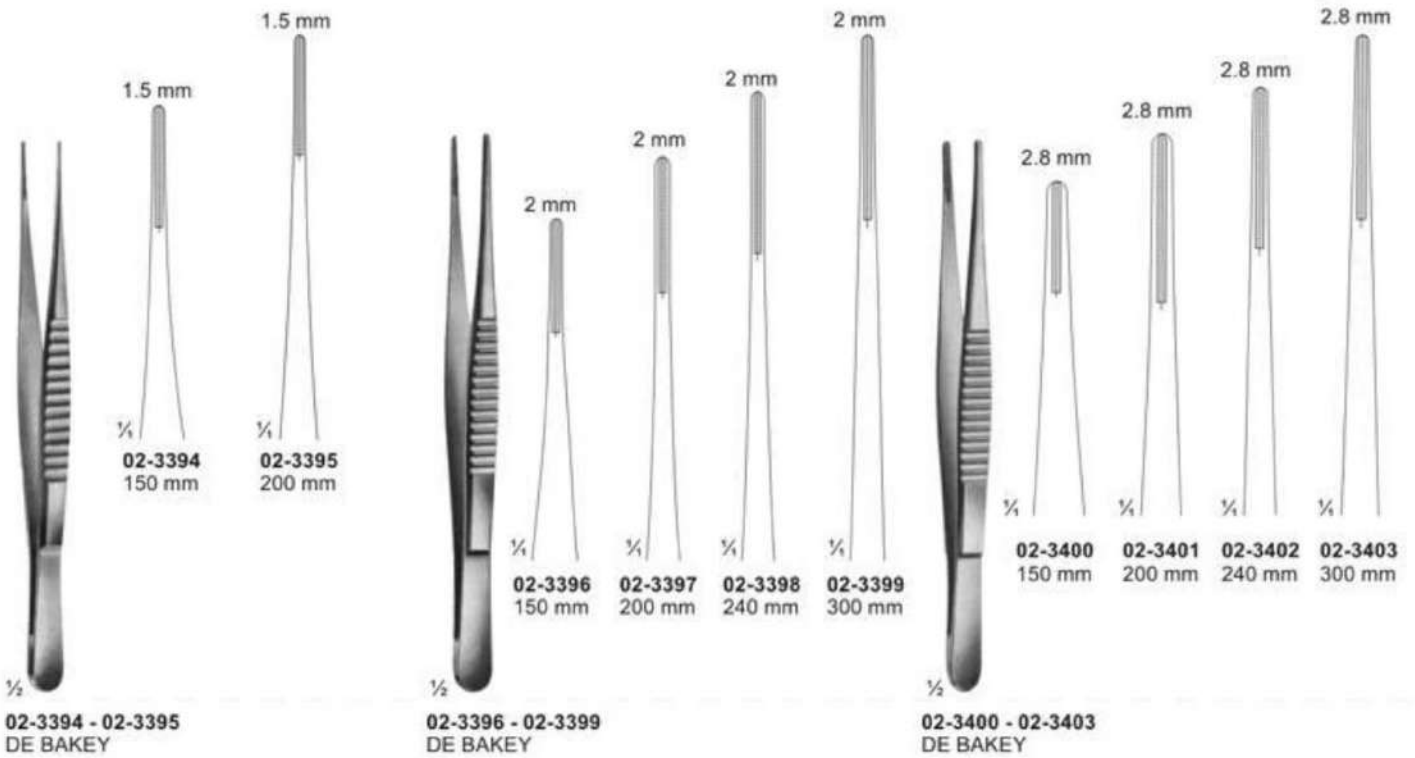

## Forceps, Bayonet - Shaped, Angular

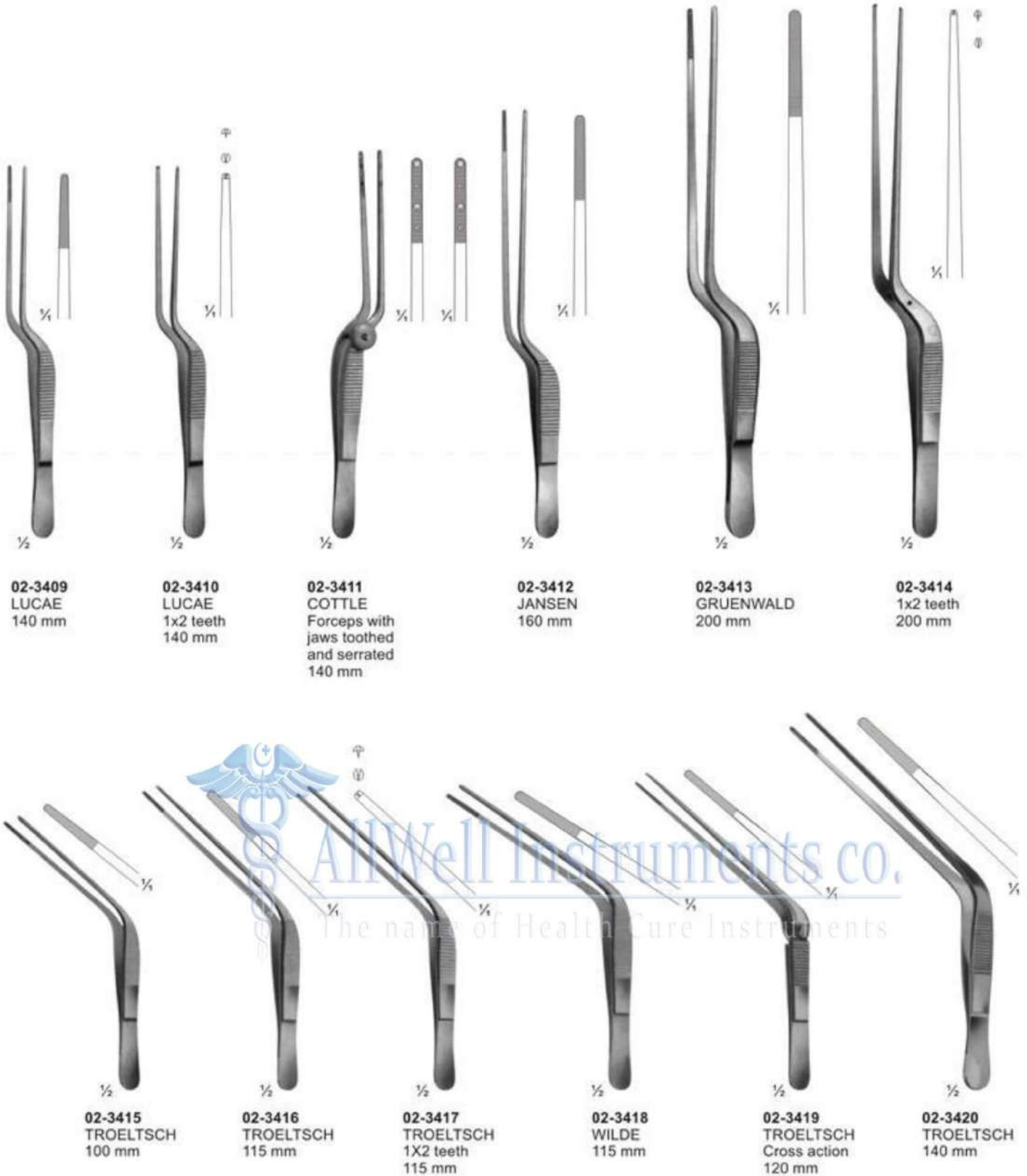

# Delicate Tissue Forceps



**02-3421**  
BISHOP-HARMON  
85 mm

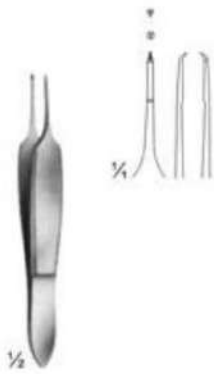

**02-3422**  
ST. MARTIN  
80 mm

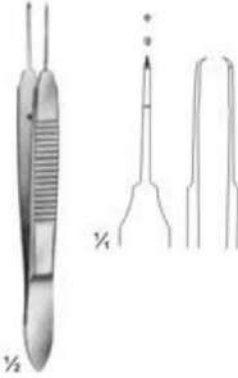

**02-3423**  
CASTROVIEJO  
teeth 0.9 mm  
100 mm

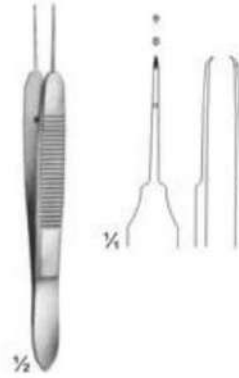

**02-3424**  
CASTROVIEJO  
teeth 0.5 mm  
100 mm

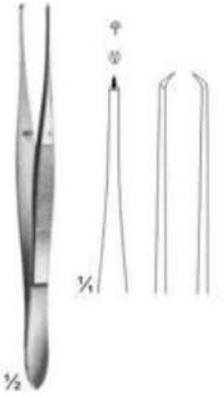

**02-3425**  
ELSCHING  
110 mm



**02-3426**  
GILL  
75 mm



**02-3427**  
GILL - HESS  
75 mm



**02-3428**  
HESS  
70 mm

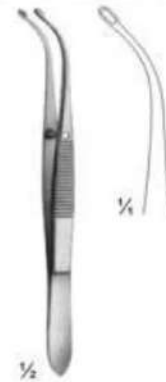

**02-3429**  
ARRUGA  
100 mm

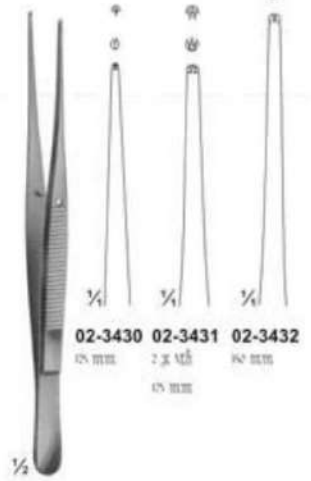

**02-3430 - 02-3432**  
SEMKEN



**02-3433**  
MICRO-ADSON  
120 mm

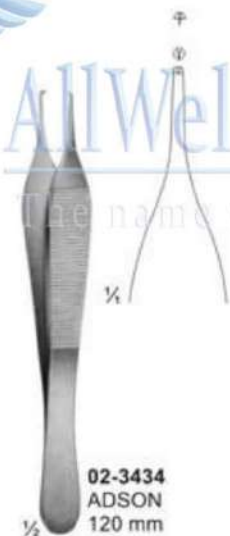

**02-3434**  
ADSON  
120 mm

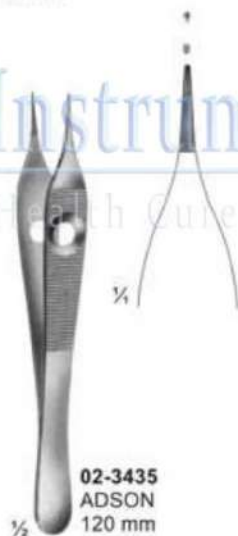

**02-3435**  
ADSON  
120 mm

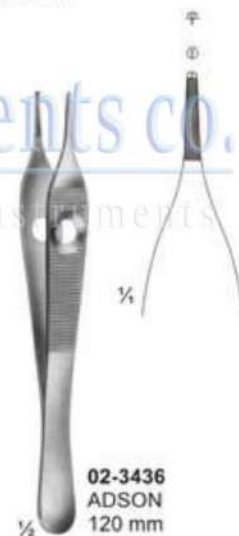

**02-3436**  
ADSON  
120 mm

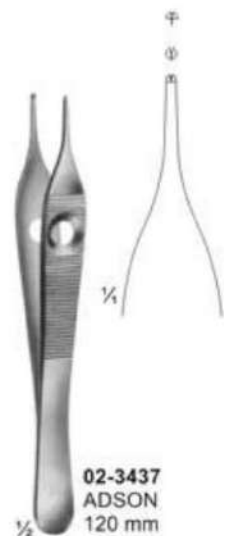

**02-3437**  
ADSON  
120 mm



AllWell Instruments co.  
The name of Health Cure Instruments



# Tissue Forceps



**02-3438**  
ADSON - BROWN  
Non-traumatic  
120 mm



**02-3439**  
BROWN  
150 mm



**02-3440**  
GRAEFE  
110 mm



**02-3441**  
GRAEFE  
With Catch  
110 mm

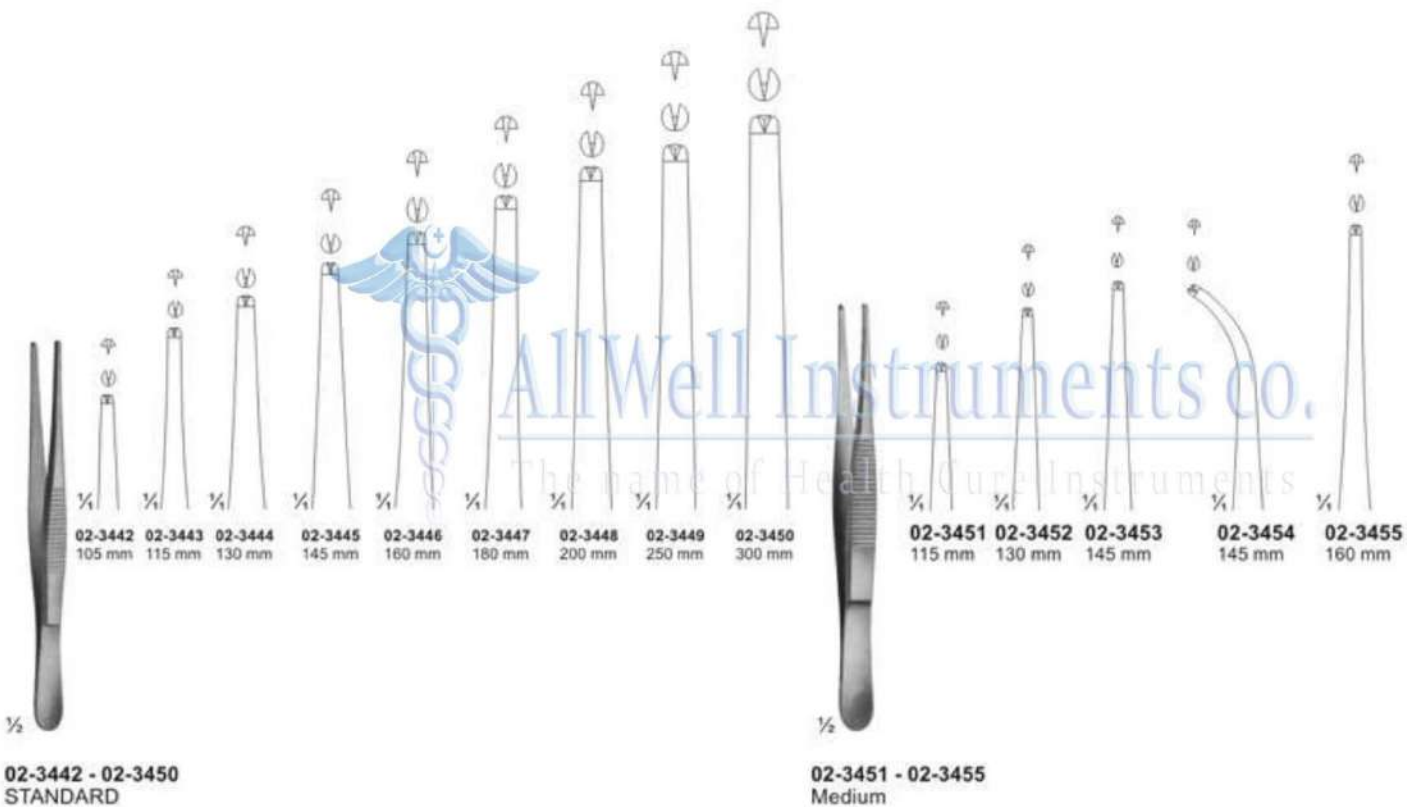

**02-3442 - 02-3450**  
STANDARD

**02-3451 - 02-3455**  
Medium

# Tissue Forceps

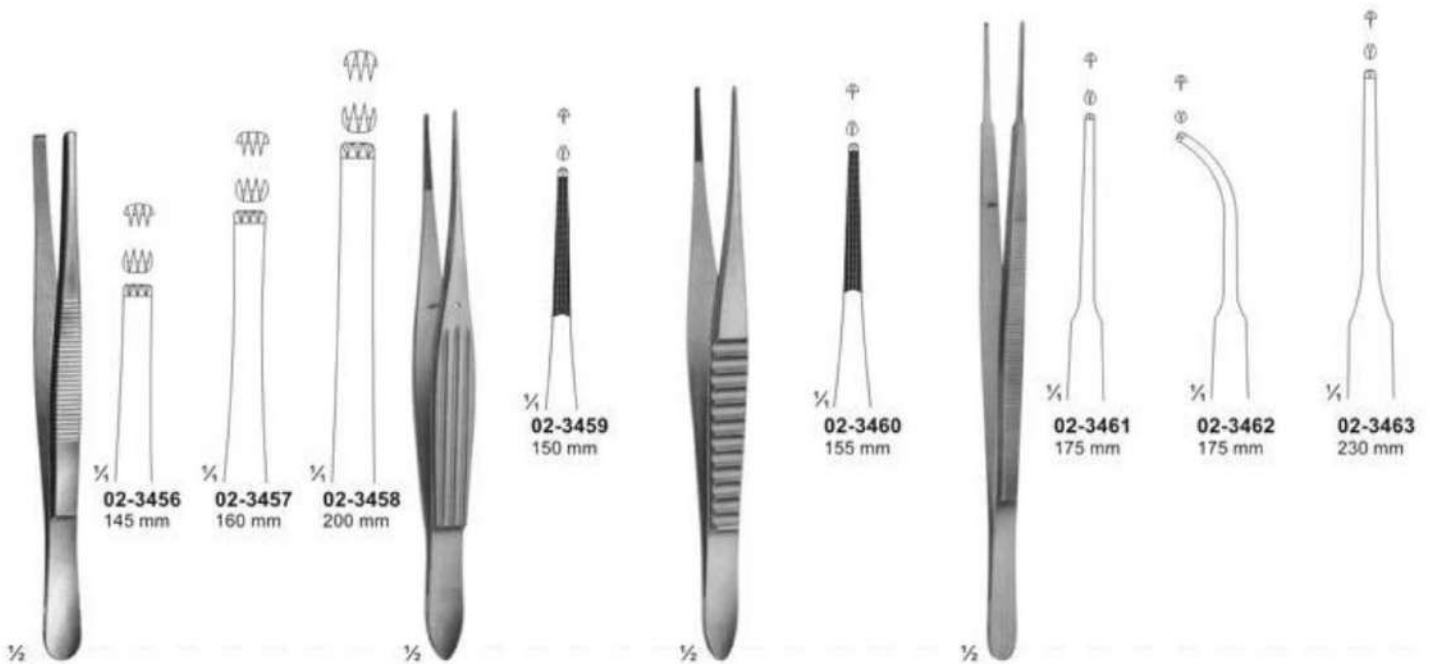

**02-3456 - 02-3458**  
3x4 teeth

**02-3459**  
MC INDOE

**02-3460**  
GILLIES

**02-3461 - 02-3463**  
GERALD



**-02-3464 - 02-3467**  
WAUGH

**02-3468**  
BROPHY

# Tissue Forceps, Lung Dissecting Forceps, Intestinal Forceps

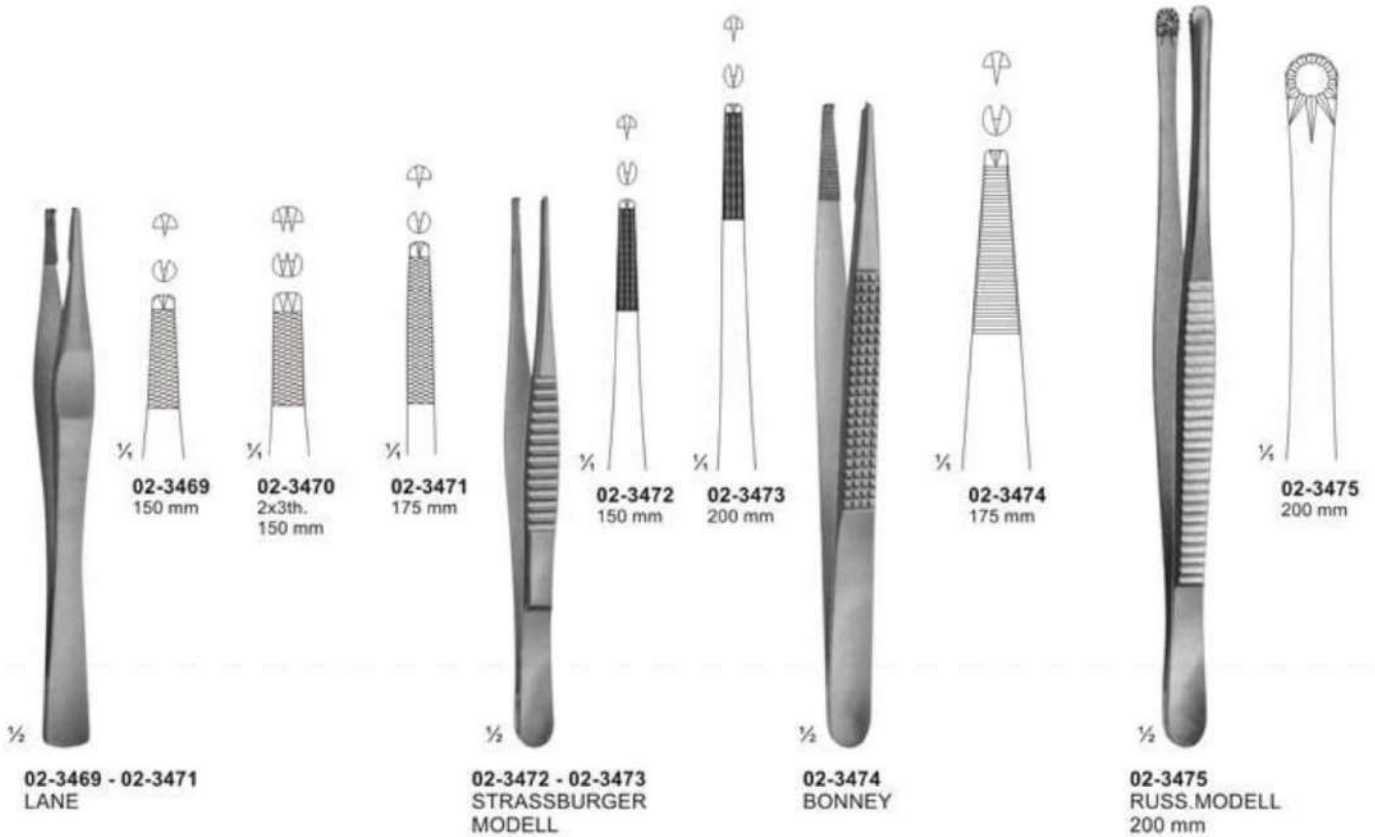



# Splinter and Cilia Forceps

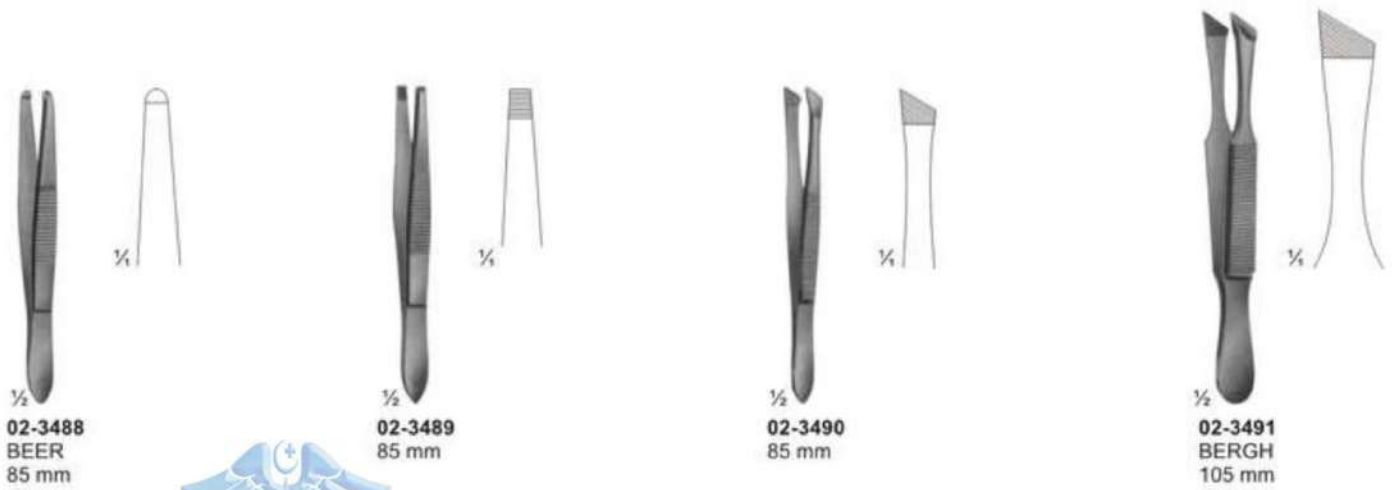

**AllWell Instruments co.**  
The name of Health Care Instruments

# Sponge and Dressing Forceps



**02-3496**  
BRYANT  
130 mm



**02-3497 - 02-3499**  
LISTER  
Sinus Forceps

130 mm 155 mm 175 mm

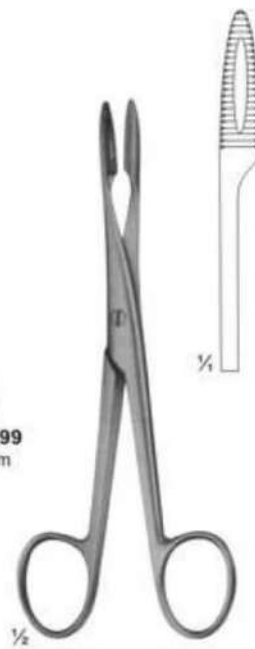

**02-3500**  
Without Ratchet  
145 mm

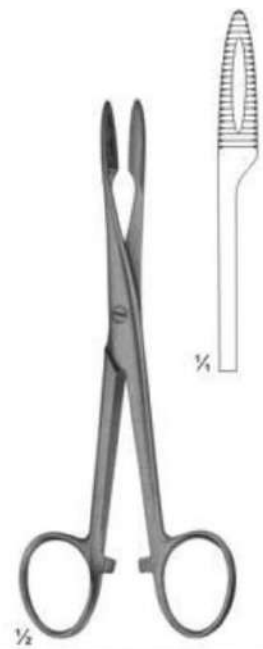

**02-3501**  
With Ratchet  
145 mm



**02-3502 - 02-3503**  
GROSS  
Without Ratchet  
180 mm

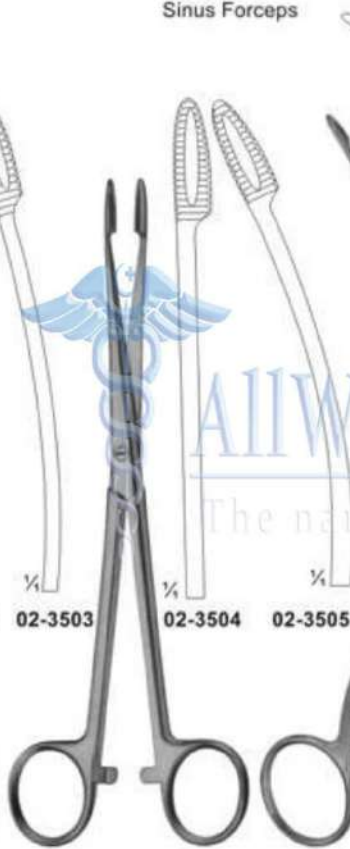

**02-3504 - 02-3505**  
GROSS  
With Ratchet  
180 mm



**02-3506**  
DUPLAY  
190 mm



**02-3507 - 02-3508**  
GROSS  
Without Ratchet  
200 mm

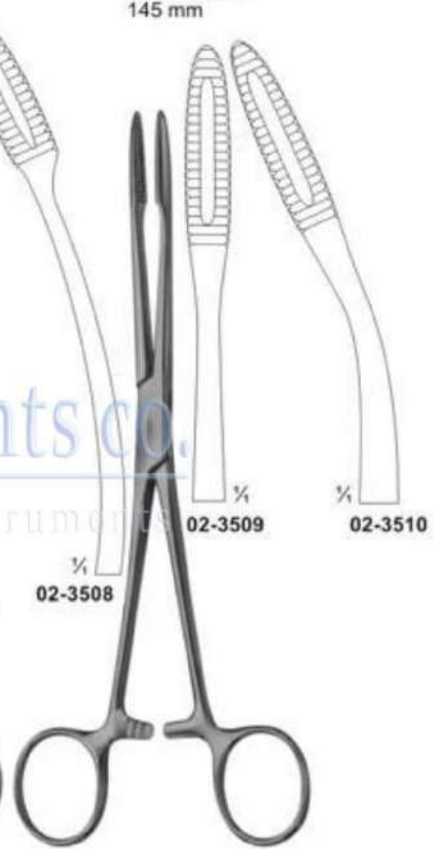

**02-3509 - 02-3510**  
GROSS  
With Ratchet  
200 mm

# Sponge and Dressing Forceps



**02-3511 - 03-3512**  
ALM  
220 mm

**02-3513 - 02-3514**  
MAIER  
Without Ratchet  
265 mm

**02-3515 - 02-3516**  
MAIER  
With Ratchet  
265 mm



## Sponge and Dressing Forceps



02-3517

02-3518

**02-3517 - 02-3518**  
 SIMS-MAIER  
 280 mm

**02-3519**  
 COLLIN  
 240 mm

**02-3520**  
 CHERON  
 Handles Laterally Angled  
 240 mm

**02-3521**  
 EMMET  
 210 mm

# Dressing, Sponge Holding, Organ and Tissue Grasping Forceps and Haemostatic Forceps

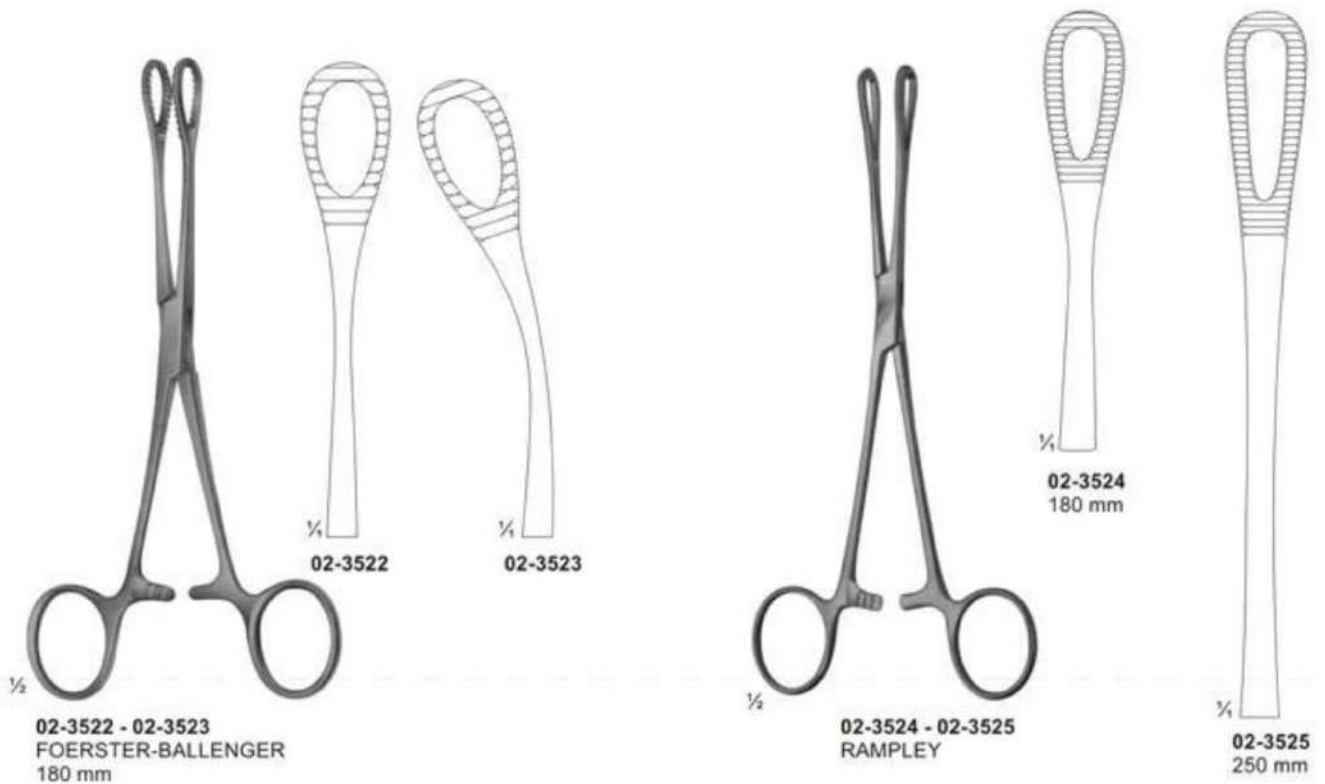

# Dressing, Sponge holding, Organ and Tissue Grasping Forceps

ATRAUMATA



**02-3531 - 02-3532**  
COLLIN

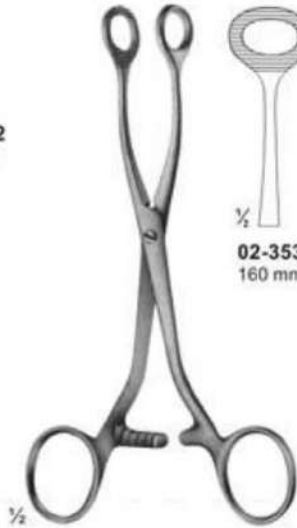

**02-3533 - 02-3535**  
COLLIN

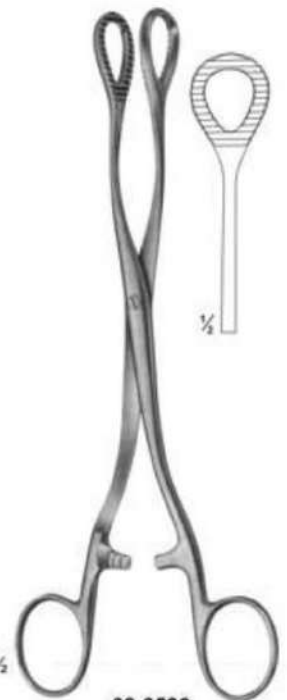

**02-3536**  
HEYWOOD-SMITH  
200 mm



**02-3537**  
NOTO  
280 mm



**02-3538**  
KELLY  
320 mm



AllWell Instruments co.  
The name of Health Cure Instruments



# Tendon Seizing Forceps

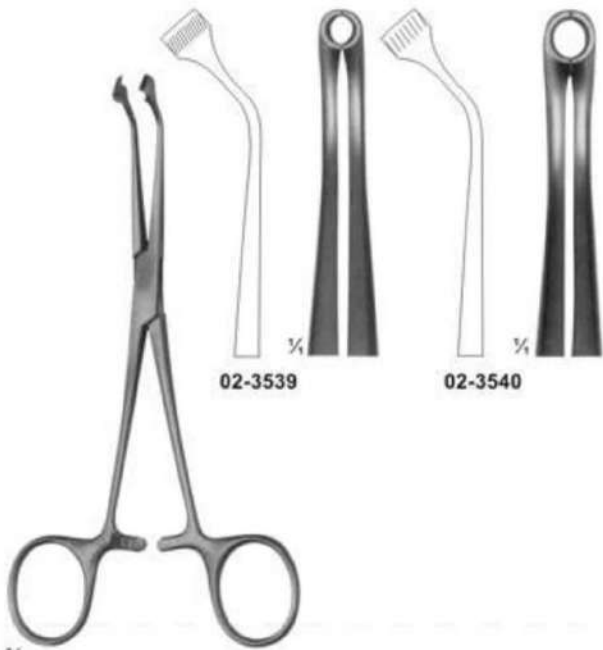

02-3539

02-3540



02-3541

1/2  
**02-3539 - 02-3540**  
HERZ  
155 mm

1/2  
**02-3541**  
JACKSON  
4 x 5 teeth  
150 mm



1/2  
**02-3542**  
Tendon interlacing  
forceps  
150 mm



1/2  
**02-3543**  
Tendon interlacing  
forceps  
150 mm



1/2  
**02-3544**  
Tendon seizing  
forceps  
120 mm

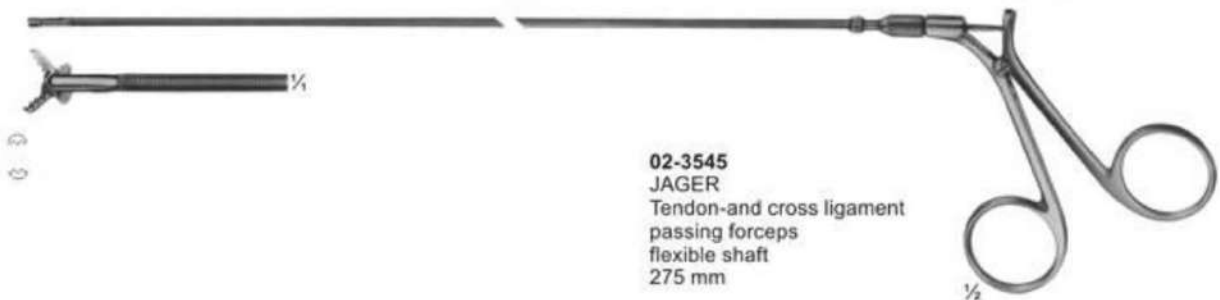

**02-3545**  
JAGER  
Tendon-and cross ligament  
passing forceps  
flexible shaft  
275 mm

## Artery Traction - and Tissue Grasping Forceps

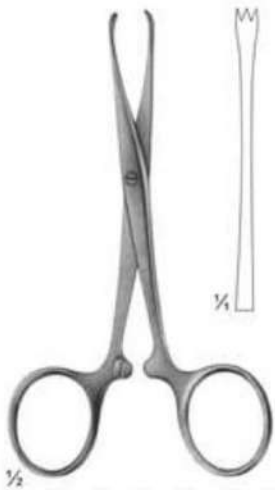

**02-3546**  
**CHAPUT**  
 2 x 3 teeth sharp  
 125 mm

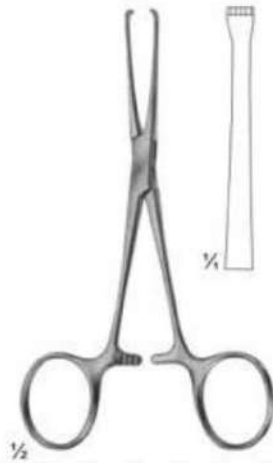

**02-3547**  
**BABY-ALLIS**  
 4 x 5 teeth  
 130 mm

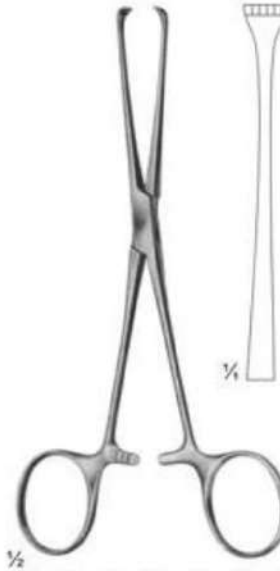

**02-3548**  
**BOYS-ALLIS**  
 5 x 6 teeth sharp  
 155 mm

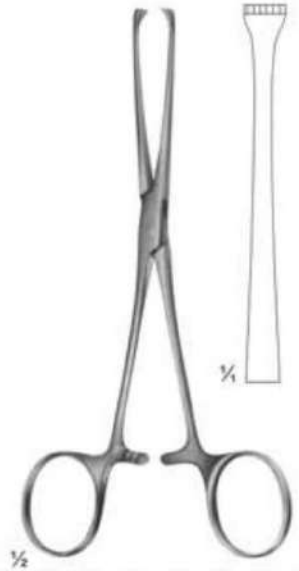

**02-3549**  
**ALLIS**  
 5 x 6 teeth blunt  
 155 mm



**02-3550**  
**LAHEY**  
 155 mm



**02-3551**  
**LAHEY**  
 155 mm



**02-3552**  
**BRAUN**  
 155 mm

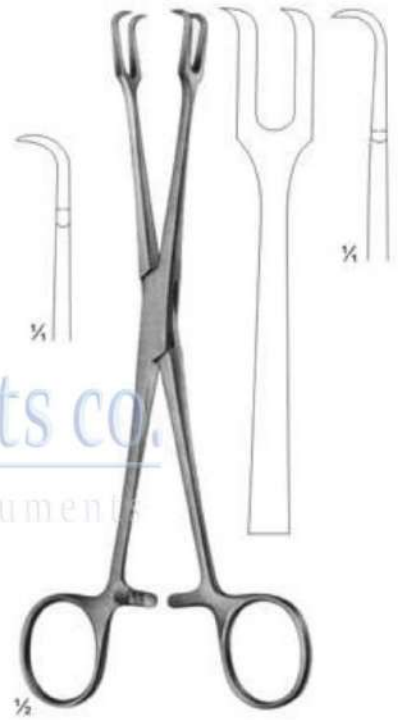

**02-3553**  
**MUSEUX**  
 200 mm





# Towel Clamps

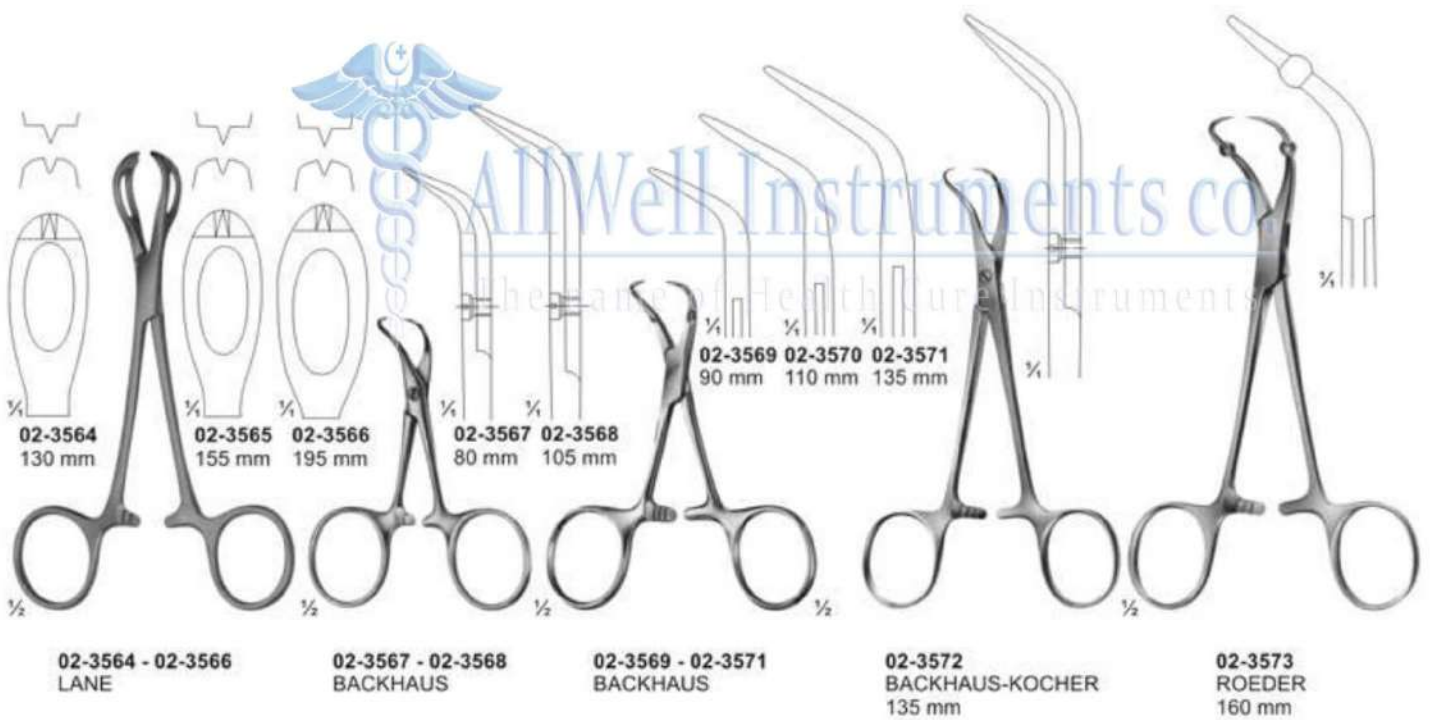

## Towel Clamps and Safety Pins.



**02-3574**  
**ROBIN**  
 with holders for tubing  
 up to 13 mm  
 135 mm



**02-3575**  
 with clip for tubing  
 up to 15 mm  
 110 mm



**02-3576**  
**LORNA**  
 non perforating  
 130 mm



**02-3577**  
 for paper cloths  
 140 mm



**02-3578**  
**BUNT**  
 105 mm



**02-3579**  
**MAYO**  
 140 mm

# Muller Vessel Clips and Bulldog Clamps

## Closing force



**02-3580**  
Straight  
50g



**02-3581**  
80g



**02-3582**  
Curved  
50g



**02-3583**  
80g



**02-3584**  
Curved tips  
50g



**02-3585**  
80g



**02-3586**  
Angled  
Shaped  
50g



**02-3587**  
80g



**02-3588**  
Muller  
Knee-bent  
50g



**02-3589**  
80g



**02-3590**  
Muller  
Ligature Forceps



Jaw, cross  
serrated  
Jaws profiles  
finally cross-  
serrated.

## Non-traumatic vessel clips, temporary.



**02-3591**  
38 mm  
48 mm



**02-3592**  
38 mm  
48 mm



**02-3593**  
58 mm



**02-3594**  
58 mm



**02-3595 - 02-3601**

- 02-3595 38 mm
- 02-3596 48 mm
- 02-3597 56 mm
- 02-3598 63 mm
- 02-3599 70 mm
- 02-3600 80 mm
- 02-3601 91 mm



**02-3602**  
DE BAKEY-  
HESS  
Length of  
Jaws 20 mm



# Bulldog Clamps



**02-3603**  
35 mm



**02-3604**  
35 mm



**02-3605**  
45 mm



**02-3606**  
45 mm



DE BAKEY

**02-3607**  
Length 50 mm  
Jaws 27 mm



DE BAKEY

**02-3608**  
Length 48 mm  
Jaws 27 mm



75°

**02-3609**  
GLOVER  
Length 57 mm  
Jaws 35 mm



**02-3610**  
DE BAKEY  
Length 73 mm  
Jaws 38 mm

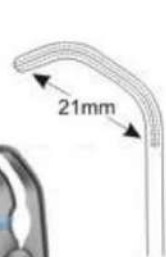

21mm



**02-3611**  
DE BAKEY  
Length 99 mm  
Jaws 63 mm



21mm



**02-3612**  
DE BAKEY  
Length 95 mm  
Jaws 54 mm



DE BAKEY

	Total length	Length of jaw
<b>02-3613</b>	80mm	25mm
<b>02-3614</b>	90mm	35mm
<b>02-3615</b>	105mm	50mm
<b>02-3616</b>	124mm	68mm



DE BAKEY

	Total length	Length of jaw
<b>02-3617</b>	78mm	25mm
<b>02-3618</b>	86mm	35mm
<b>02-3619</b>	97mm	50mm
<b>02-3620</b>	114mm	68mm



GLOVER

	Total length	Length of jaw
<b>02-3621</b>	68mm	33mm
<b>02-3622</b>	96mm	50mm
<b>02-3623</b>	117mm	69mm



GLOVER

	Total length	Length of jaw
<b>02-3624</b>	65mm	33mm
<b>02-3625</b>	91mm	50mm
<b>02-3626</b>	110mm	69mm

# Delicate Haemostatic Forceps



02-3627  
CARREL  
85 mm



02-3628 - 02-3631  
BABY-MOSQUITO  
(HARTMANN)  
100 mm



02-3632 - 02-3635  
MICRO-HALSTED  
125 mm



02-3636 - 02-3639  
HALSTED-MOSQUITO  
125 mm



02-3640 - 02-3641  
PROVIDENCE-HOSPITAL  
140 mm



02-3642 - 02-3643  
KELLY  
140 mm



02-3644 - 02-3645  
DANDY  
Curved sideways  
140 mm

## Delicate Haemostatic Forceps

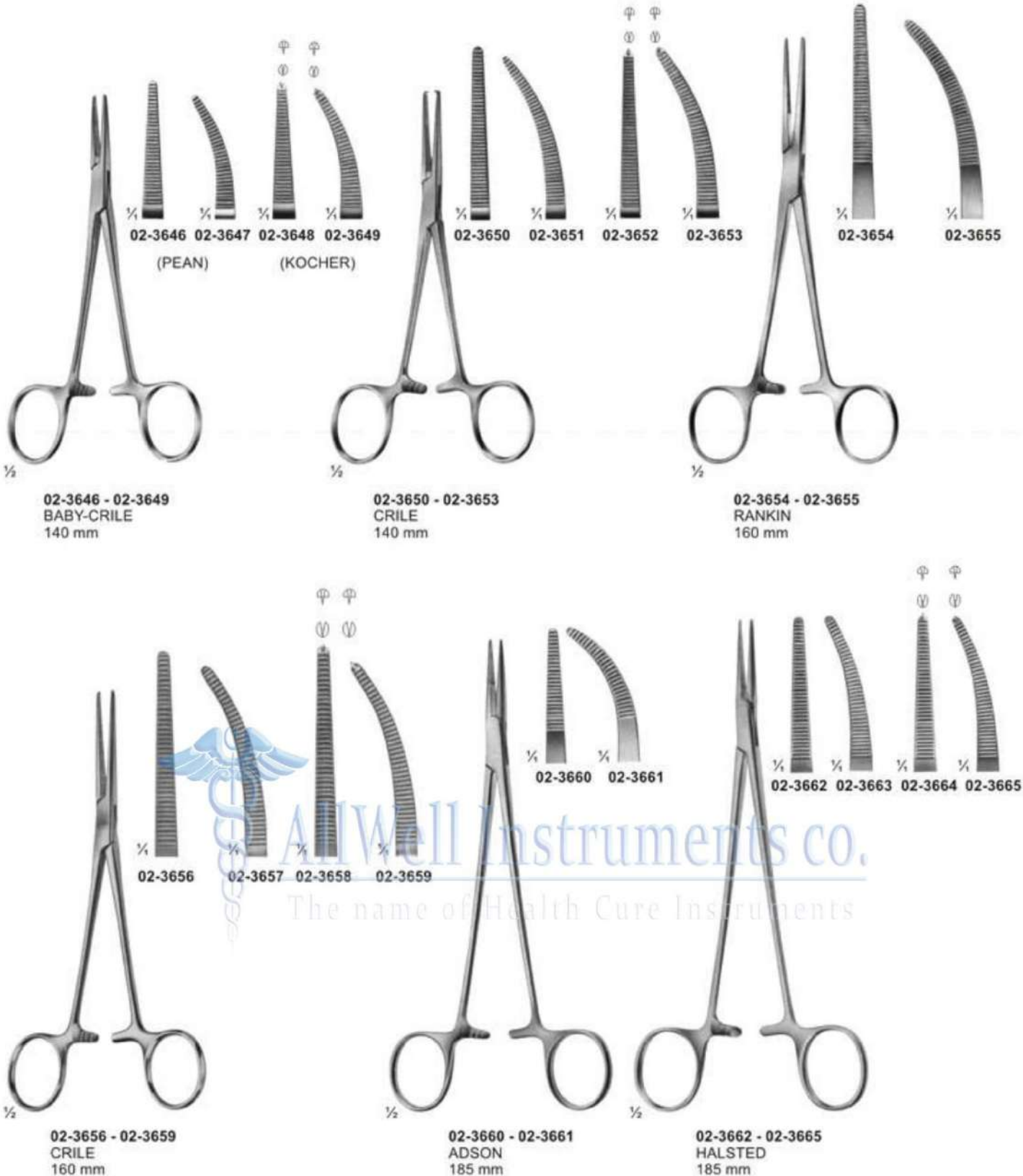



# Delicate Haemostatic Forceps

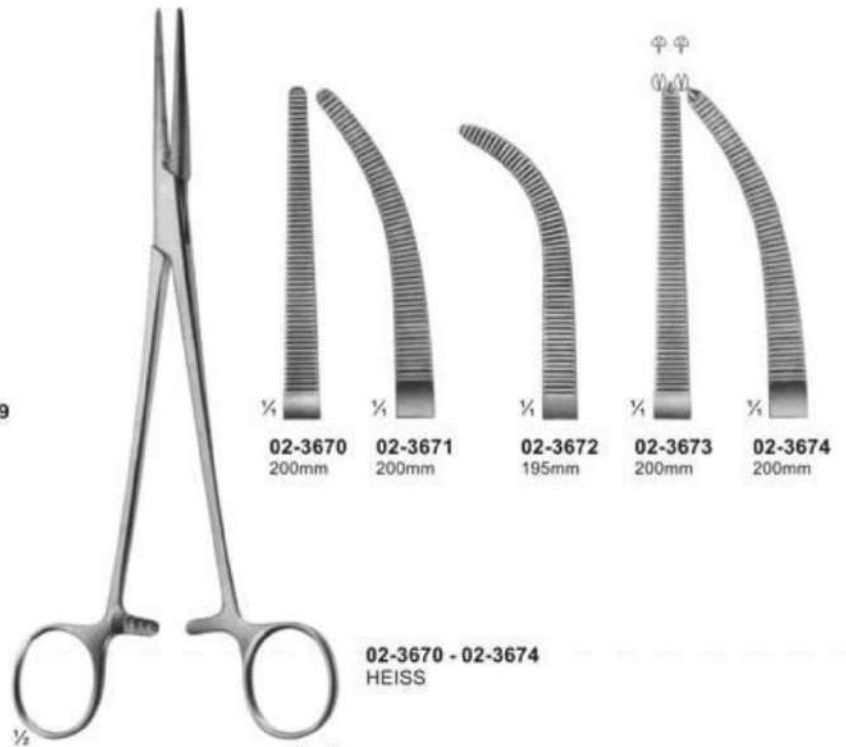
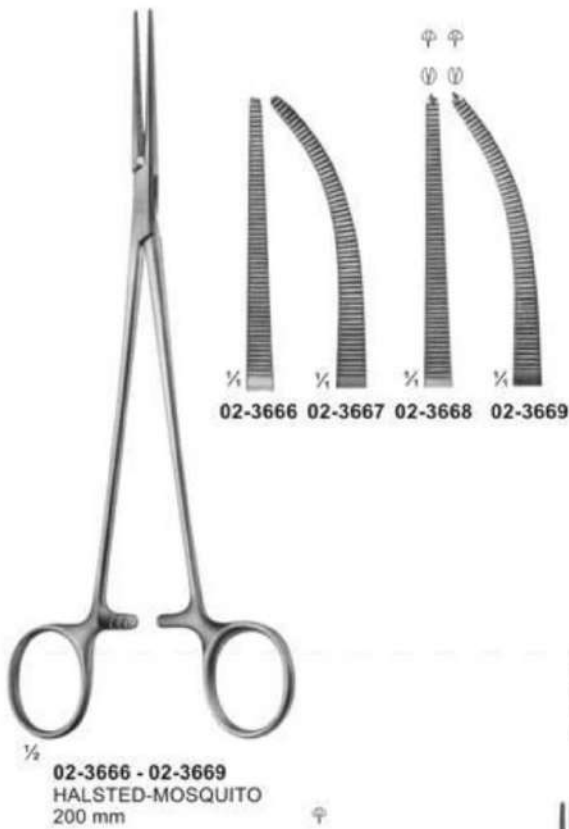

AllWell Instruments Co.  
The name of Health Cure Instruments

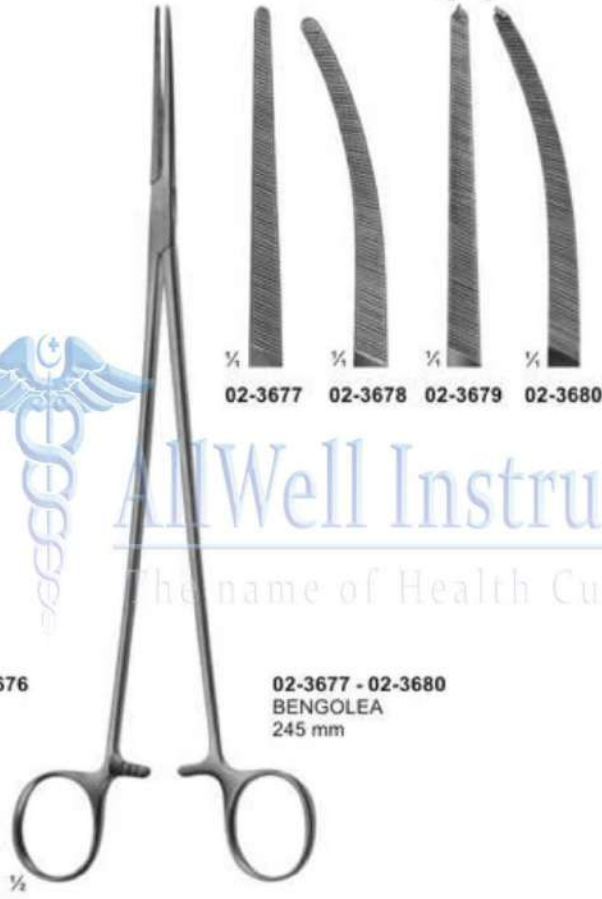

# Haemostatic Forceps

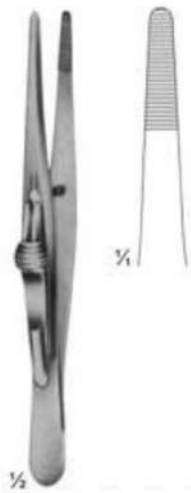

**02-3682**  
FRICKE  
Artery forceps  
130 mm



**02-3683**  
KRONLEIN  
130 mm

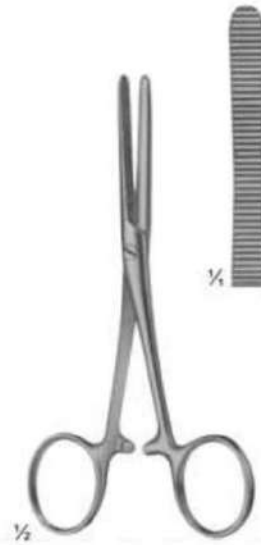

**02-3684**  
PEAN  
125 mm



**02-3685 - 02-3686**  
PEAN



**02-3686**  
140 mm



**02-3687**  
PEAN  
125mm



**02-3688**  
165 mm

**02-3689**  
185 mm

**02-3688 - 02-3689**  
PEAN

# Haemostatic Forceps



**02-3690 - 02-3693**  
PEAN  
Slender type

02-3690	02-3691	02-3692	02-3693
130 mm	140 mm	130 mm	140 mm

**02-3694 - 02-3702**  
SPENCER-WELLS

02-3695	02-3696	02-3697	02-3698	02-3699	02-3700	02-3701	02-3702
130 mm	150 mm	175 mm	200 mm	130 mm	150 mm	175 mm	200 mm

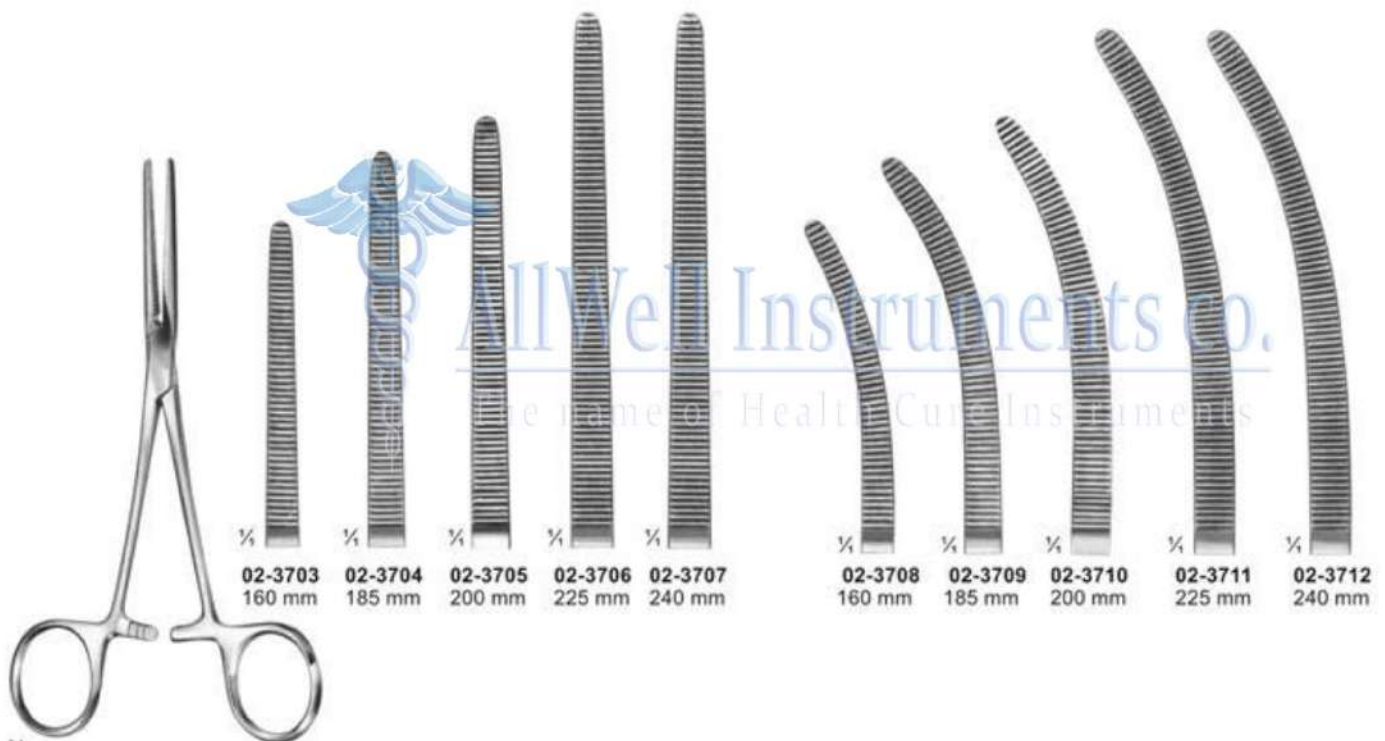

**02-3703 - 02-3712**  
ROCHESTER-PEAN

02-3703	02-3704	02-3705	02-3706	02-3707	02-3708	02-3709	02-3710	02-3711	02-3712
160 mm	185 mm	200 mm	225 mm	240 mm	160 mm	185 mm	200 mm	225 mm	240 mm



# Haemostatic Forceps

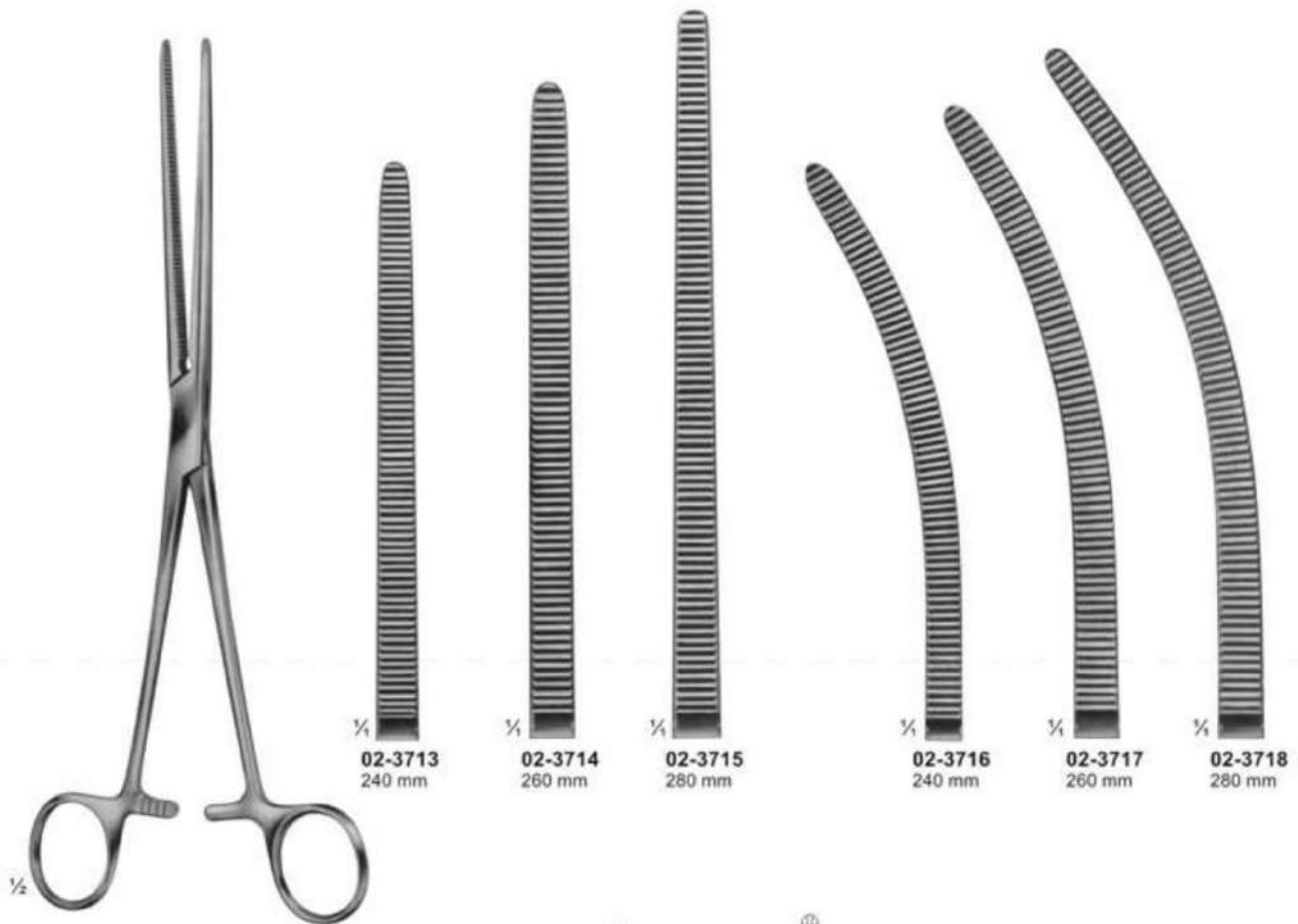

**02-3713 - 02-3718**  
PEAN

**02-3713**  
240 mm

**02-3714**  
260 mm

**02-3715**  
280 mm

**02-3716**  
240 mm

**02-3717**  
260 mm

**02-3718**  
280 mm

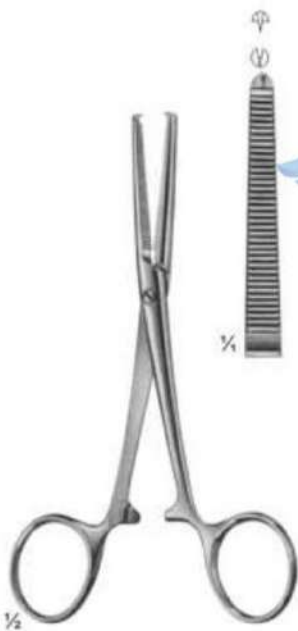

**02-3719**  
KOCHER  
Strong Pattern  
145 mm



**02-3720 - 02-3722**  
KOCHER

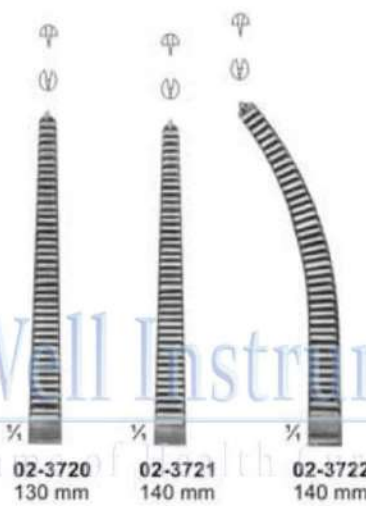

**02-3720**  
130 mm

**02-3721**  
140 mm

**02-3722**  
140 mm



**02-3723 - 02-3724**  
ROCHESTER-OGHSNER  
140 mm

**02-3723**

**02-3724**

# Haemostatic Forceps

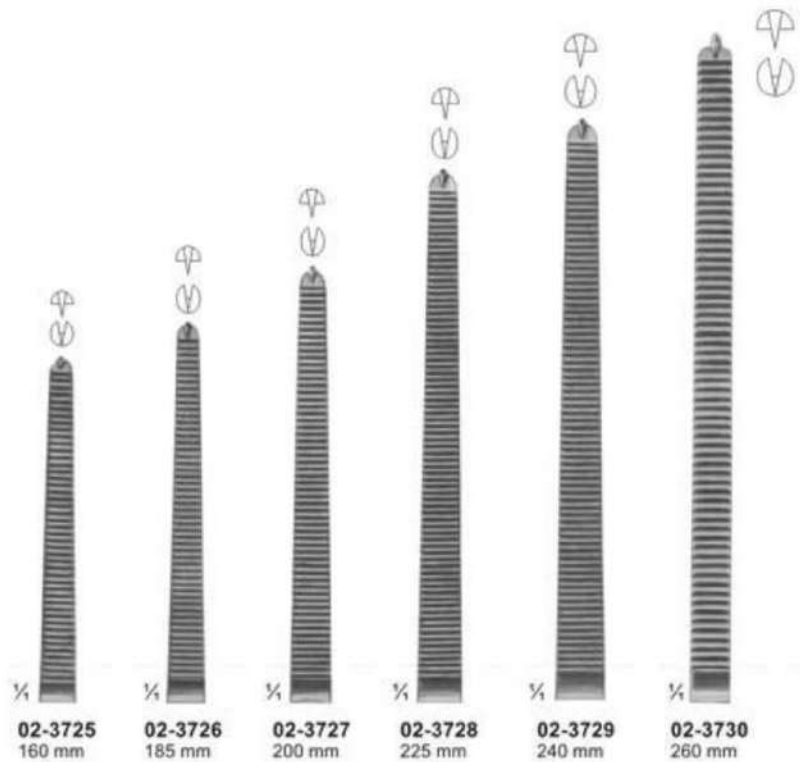

02-3725 - 02-3736  
KOCHER-OCHSNER

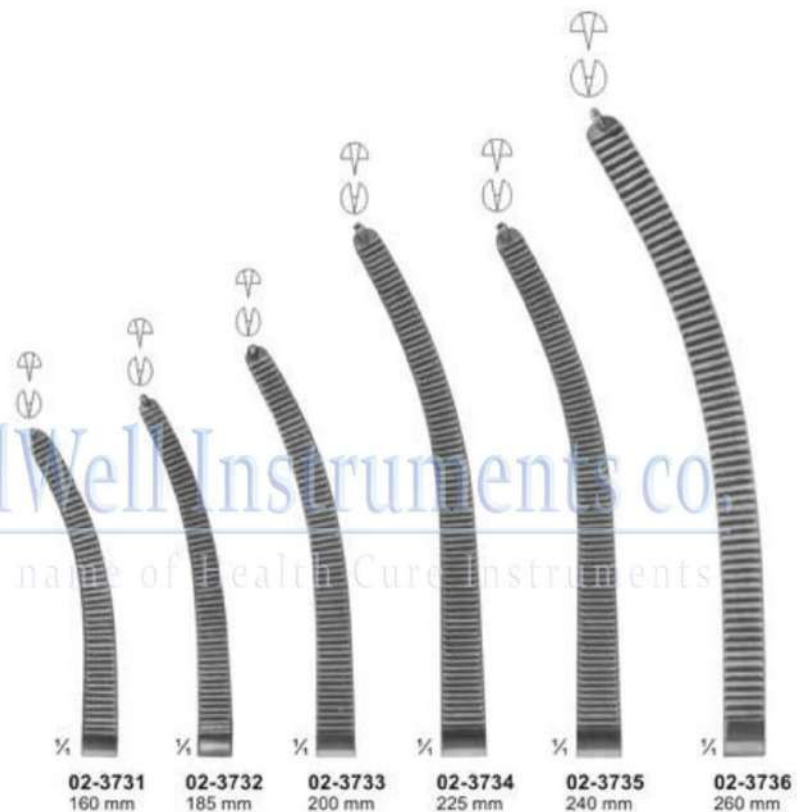

# Haemostatic Forceps, Special Pattern, Tonsil Forceps

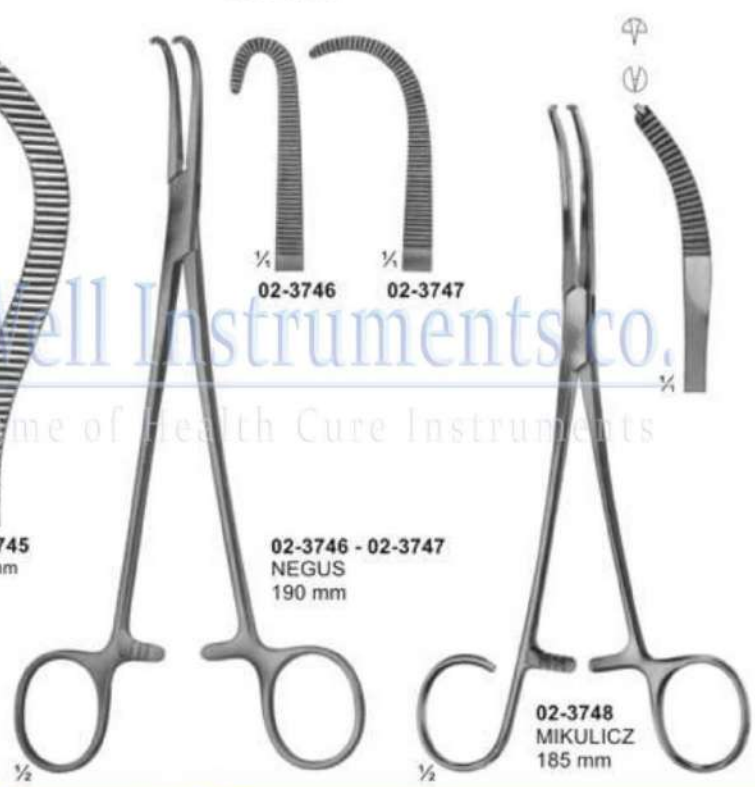
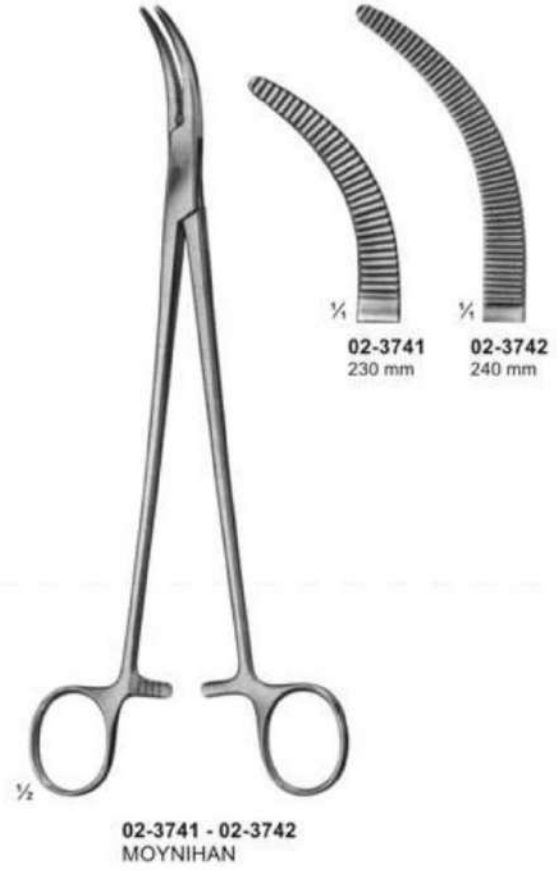



# Dissecting- and Ligature Forceps



**02-3749**  
MICRO-ADSON  
140 mm



**02-3750**  
BABY-OVERHOLT  
135 mm



**02-3751 - 02-3752**  
BABY-MIXTER

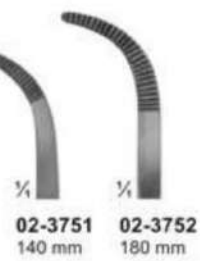

**02-3753 - 02-3754**  
BABY-ADSON

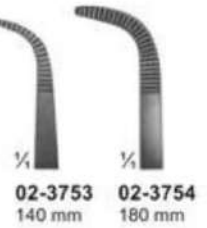

**02-3755**  
NISSEN



**02-3756 - 02-3757**  
YASARGIL  
195 mm

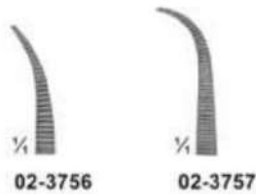

**02-3758**  
OVERHOLT-MIXTER



AllWell Instruments co.  
The name of Health Cure Instruments

## Dissecting- and Ligature Forceps

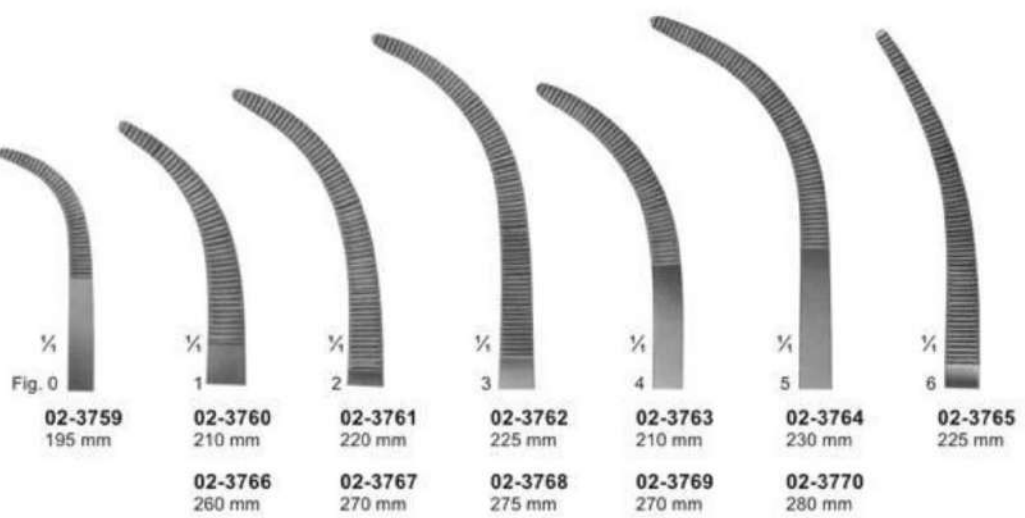

02-3759 - 02-3770  
OVERHOLT-GEISSENDOERFER

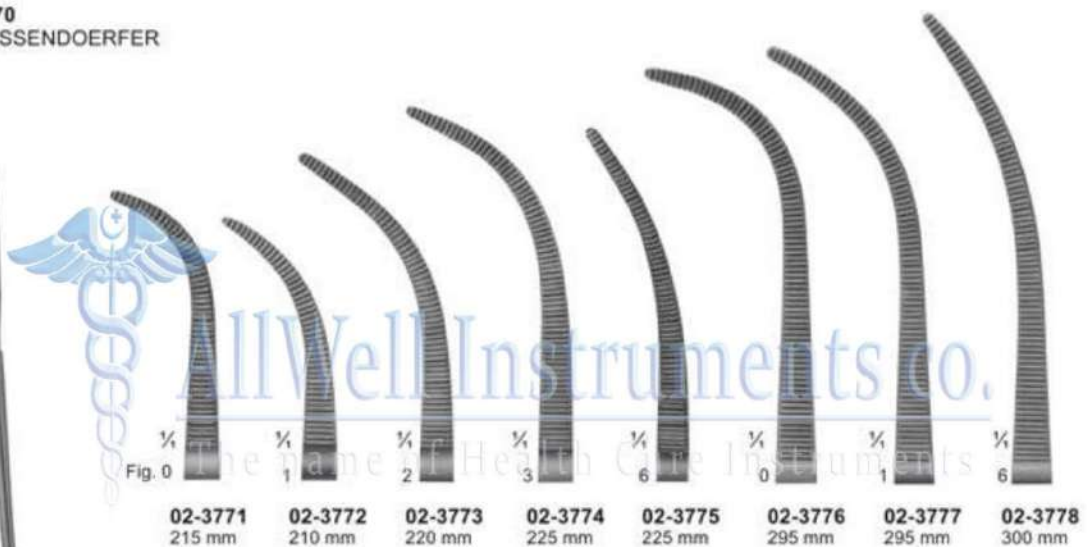

02-3771 - 02-3778  
OVERHOLT  
fine pattern

## Dissecting- and Ligature Forceps



**02-3779**  
MIXTER-O'SHAUGNESSY  
190 mm



**02-3780**  
HEISS  
195 mm

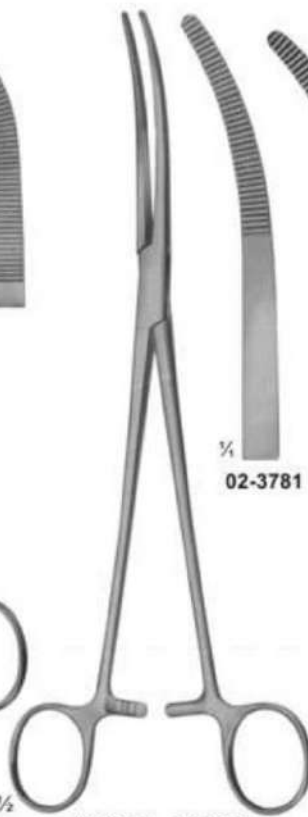

**02-3781**   **02-3782**   **02-3783**   **02-3784**   **02-3785**

**02-3781 - 02-3785**  
RUMEL  
240 mm

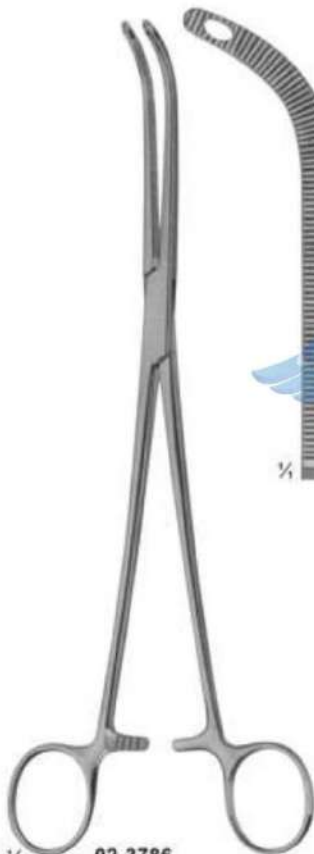

**02-3786**  
FINOCHIETTO  
245 mm



**02-3787**  
MIXTER  
230 mm



**02-3788**  
LAWRENCE  
270 mm



**02-3789 - 02-3790**  
ZENKER

**02-3789**  
300 mm

**02-3790**  
290 mm

**AllWell Instruments co.**  
The name of Health Care Instruments



## Dissecting- and Ligature Forceps

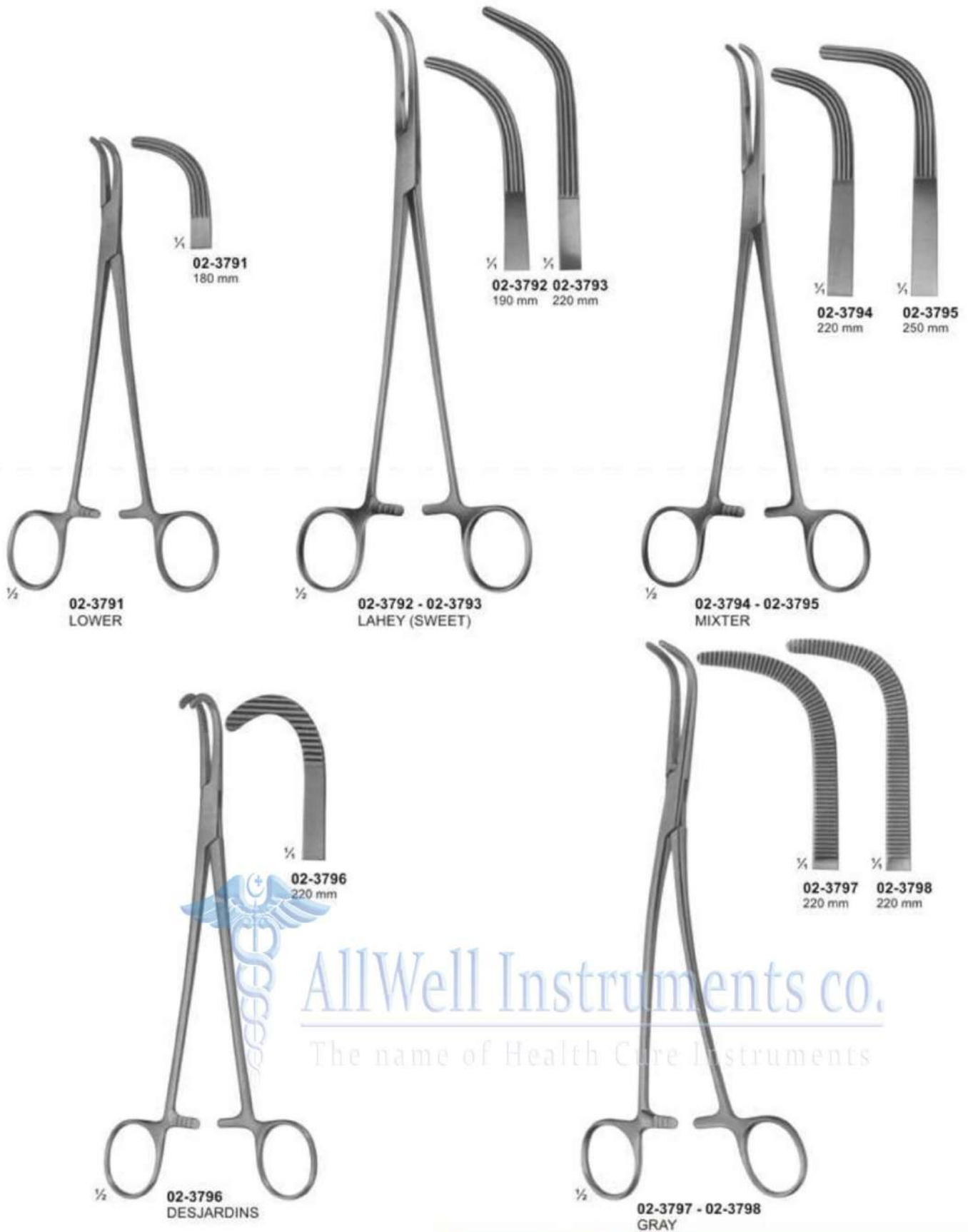

AllWell Instruments co.  
The name of Health Care Instruments

# Peritoneum Forceps



**02-3799**  
BABY-MIKULICZ  
140 mm



**02-3800**  
MIKULICZ  
185 mm

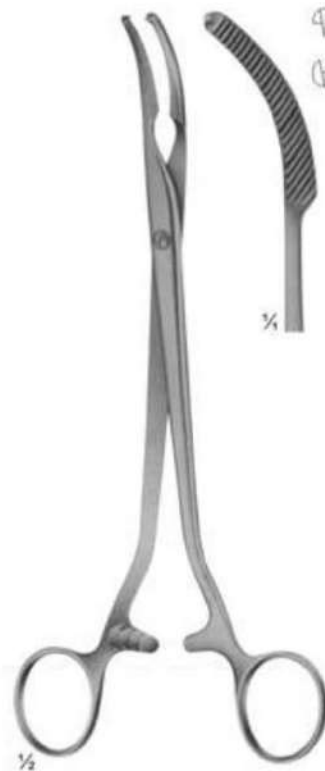

**02-3801**  
MIKULICZ  
205 mm

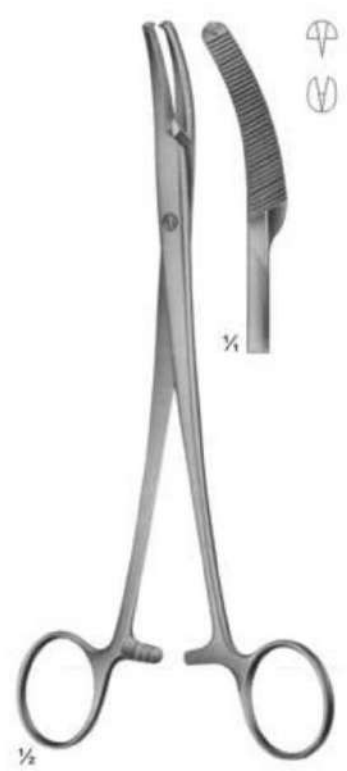

**02-3802**  
MIKULICZ  
200 mm



**02-3803**  
MIKULICZ  
205 mm



**02-3804**  
MIKULICZ  
185 mm



**02-3805 - 02-3806**  
FAURE  
205 mm

AllWell Instruments Co.

The name of Health Care Instruments

# Hysterectomy and Haemostatic Forceps



02-3807 - 02-3808  
PHANEUF



02-3809 - 02-3810  
HEANEY modif.



02-3811  
HEANEY



02-3812  
WERTHEIM



02-3813  
WERTHEIM



02-3814  
WERTHEIM

AllWell Instruments co.

The name of Health Cure Instruments



# Atraumata Hysterectomy Forceps and Vaginal Clamps ATRAUMATA



½ **02-3815 - 02-3818**  
HEANEY



¼ **02-3815**  
225 mm



¼ **02-3816**  
220 mm



¼ **02-3817**  
215 mm



¼ **02-3818**  
205 mm



½ **02-3819 - 02-3822**  
WERTHEIM  
Parametrium clamps



¼ **02-3819**  
250 mm



¼ **02-3820**  
245 mm



¼ **02-3821**  
240 mm



¼ **02-3822**  
220 mm

# Hysterectomy Forceps and Vaginal Clamps and Compression Forceps ATRAUMATA



02-3823  
WERTHEIM  
Hysterectomy Forceps  
255 mm

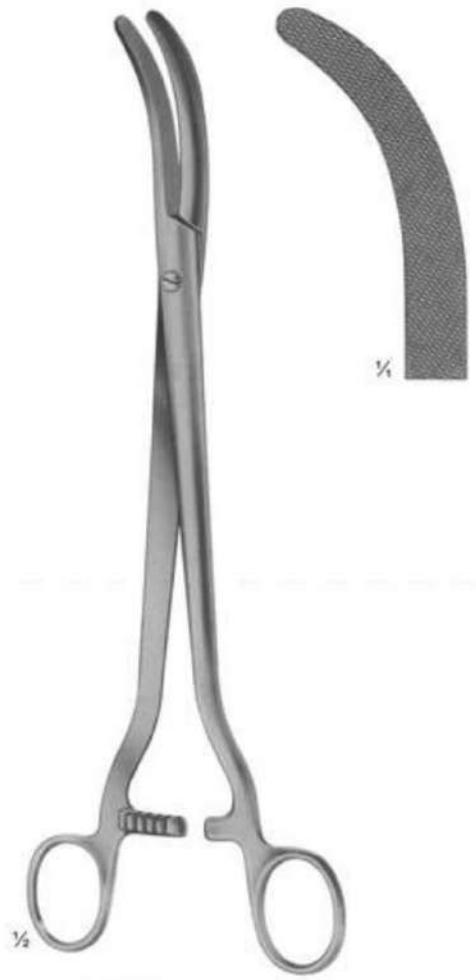

02-3824  
WERTHEIM  
Parametrium Clamp  
260 mm

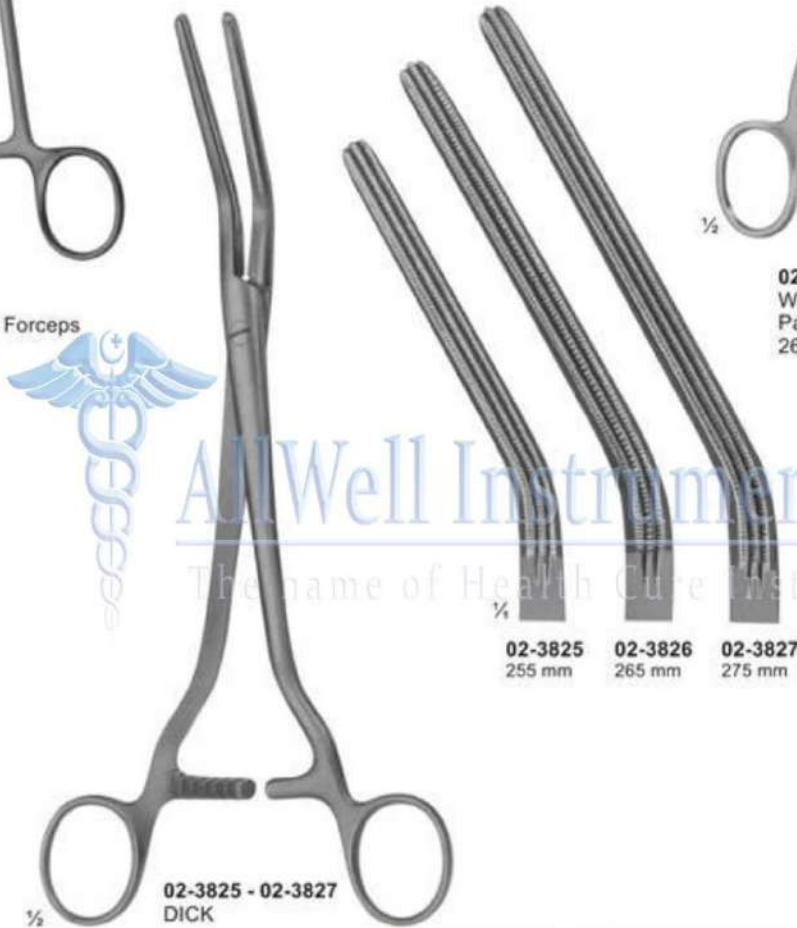

02-3825 - 02-3827  
DICK

02-3825 255 mm    02-3826 265 mm    02-3827 275 mm



AllWell Instruments co.  
The name of Health Care Instruments

# Clamps and Compression Forceps

## ATRAUMATA



**02-3828**  
WERTHEIM  
250 mm



**02-3831**  
80 mm

**02-3830**  
60 mm



**02-3829**  
WERTHEIM-CULLEN  
215 mm



**02-3830 - 02-3831**  
230 mm



AllWell Instruments co.

The name of Health Care Instruments



## Needle Holders For Micro Surgery



**02-3832**  
**ROHRSCHEIDER**  
With copper inserts  
100 mm



**02-3833**  
**KALT**  
With catch  
135 mm



**02-3834**  
**ARRUGA**  
With catch  
135 mm



**02-3835 - 02-3836**  
**CASTROVIEJO**  
With catch  
145 mm



**02-3837 - 02-3838**  
**CASTROVIEJO**  
With Catch  
160 mm



**02-3839 - 02-3840**  
Without catch  
185 mm



**02-3841 - 02-3842**  
**JACOBSON**  
185 mm



**02-3843**  
Without catch  
195 mm



**02-3844 - 02-3845**  
**YASARGIL**  
With catch  
200 mm

# Micro Needle Holders With Round Handles and Bayonet - Shaped



**02-3846 - 02-3847**  
BARRAQUER  
Without catch



**02-3848 - 02-3849**  
BARRAQUER  
Without catch  
120 mm



**02-3850 - 02-3851**  
BARRAQUER  
With catch  
120 mm



**02-3852 - 02-3853**  
With Catch  
150 mm



**02-3854**  
MULLER  
With Locking  
Mechanism  
145 mm



**02-3855 - 02-3856**  
BROCK  
Without catch  
150 mm



**02-3857 - 02-3858**  
YASARGIL  
200 mm



**02-3859 - 02-3860**  
YASARGIL  
225 mm



**02-3861**  
YASARGIL  
245 mm

# Needle Holders



**02-3862**  
**CONVERSE**  
125 mm



Smooth jaws

**02-3863**  
**WEBSTER**  
125 mm



**02-3864**  
Smooth jaws

**02-3864 - 02-3865**  
**HALSEY**  
130 mm



**02-3866**  
**DERF**  
125 mm



**02-3867**  
**DOYEN**  
125 mm



**02-3868**  
**BAUMGARTNER**  
145 mm



Fine Pattern

**02-3869**  
**CRILE-WOOD**  
150 mm



Heavy pattern

**02-3870**  
**CRILE-WOOD**  
160 mm



**02-3871**  
**CRILE-MURRAY**  
150 mm



**02-3872**  
**KILNER**  
135 mm



Designed for Frontal and Palate Suture

**02-3873**  
**ADSON**  
175 mm



# Needle Holders



# Needle Holders

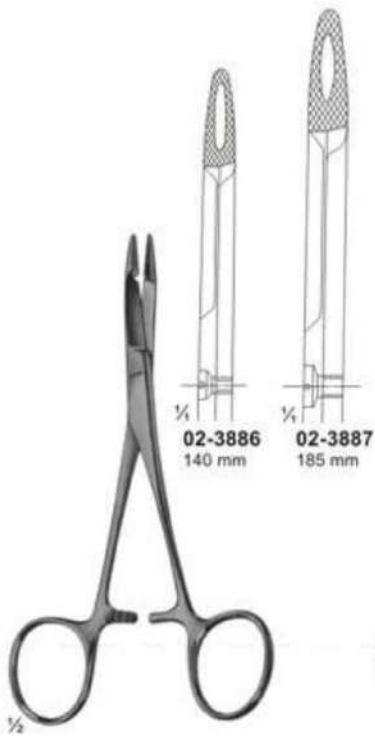

**02-3886 - 02-3887**  
**HEGAR-OLSEN**  
Needle Holders with Scissors

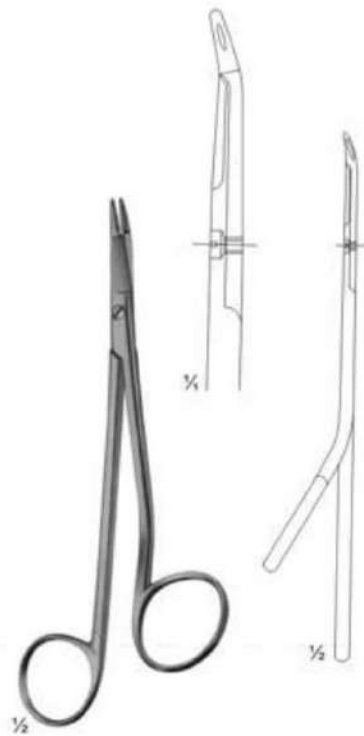

**02-3888**  
**GILLIES**  
Needle Holders with Scissors  
150 mm



**02-3889**  
**GILLIES**  
Needle Holders with Scissors  
160 mm

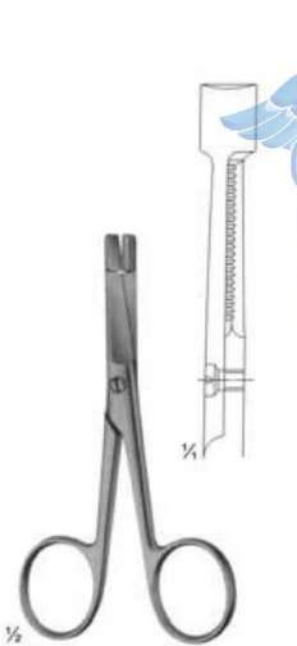

**02-3890**  
**EISELSBERG**  
Needle Holders with Scissors  
115 mm

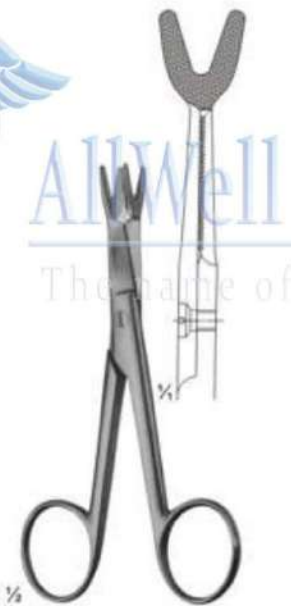

**02-3891**  
**SCHOEMAKER-LOTH**  
Needle Holders with Scissors  
125 mm



**02-3892**  
**CRILE**  
150 mm



**02-3893**  
**TOENNIS**  
Elastic pattern for  
dura-or intestinal suture  
180 mm

## Needle Holders

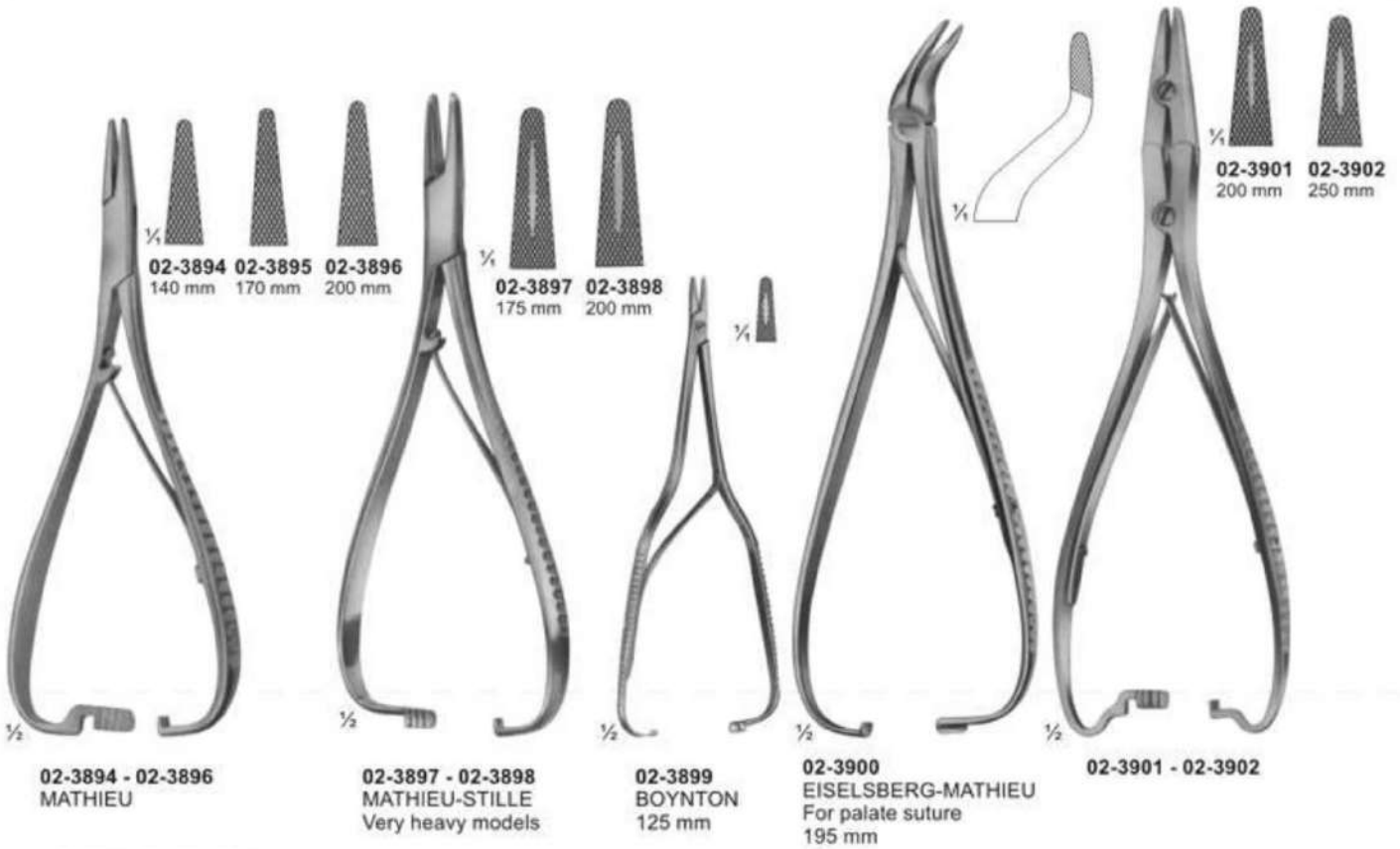

## Spare Needles





## Suture Instruments - Reverdin Needles



02-3909 - 02-3912  
REVERDIN  
140 mm



02-3913 - 02-3916  
REVERDIN  
195 mm

02-3917 - 02-3920  
REVERDIN  
220 mm

## Suture Instruments - Ligature Needles



## Suture Instruments - Ligature Needles



1/2  
**02-3933**  
HURD  
for right hand  
sharp  
210 mm



1/2  
**02-3934**  
HURD  
for left hand  
sharp  
210 mm



1/2  
**02-3935**  
DESCHAMPS  
for right hand  
sharp  
215 mm



1/2  
**02-3936**  
DESCHAMPS  
for left hand  
sharp  
215 mm



1/2  
**02-3937**  
JONESCO  
Needle for wire suture  
185 mm



1/2  
**02-3938**  
CLAUS VAN EICKEN  
Needle for wire suture  
250 mm



1/2  
**02-3939**  
150 mm

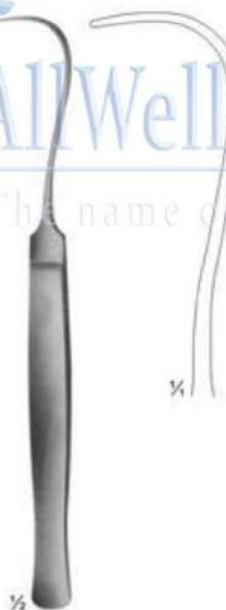

1/2  
**02-3940**  
SYME  
170 mm



1/2  
**02-3941**  
COOPER  
205 mm



1/2  
**02-3942**  
KOCHER  
205 mm





# Ligature Needles



## Guiding Probes and Suture Instruments

4.5 mm



**02-3949**  
KOENIG  
195 mm

7 mm



**02-3950**  
KOENIG  
200 mm

8 mm

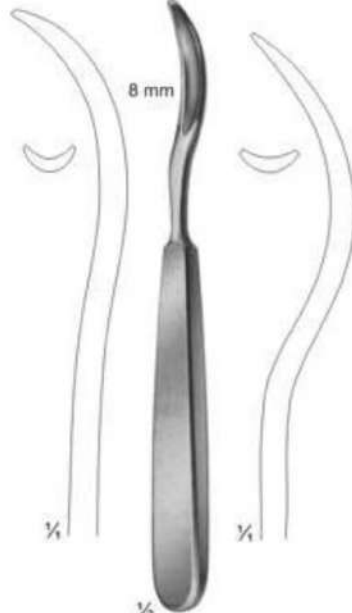

**02-3951**  
SCHMIEDEN  
185 mm

11 mm



**02-3952**  
KOCHER  
150 mm

12 mm



**02-3953**  
KOCHER  
170 mm

5 mm



**02-3954**  
PAYR  
195 mm

5 mm



**02-3955**  
PAYR  
225 mm

4 mm



**02-3956**  
280 mm

4.5 mm



**02-3957**  
KIRSCHNER  
255 mm

8 mm



**02-3958**  
BRUNNER  
245 mm

**02-3959**

Knot tier and  
ligature Adjuster  
230 mm



**02-3960**

CASPAR  
Knot tier and  
ligature Adjuster  
230 mm



**02-3961**

WIENER MODELL  
Suture hook  
235 mm



AllWell Instruments co.  
The name of Health Cure Instruments

## Directors and Probes

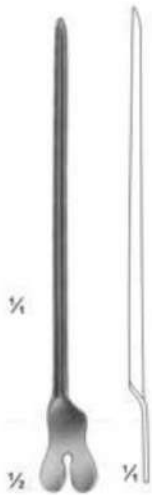

**02-3962 - 02-3964**  
02-3962 130 mm  
02-3963 145 mm  
02-3964 160 mm  
Directors



**02-3965**  
DOYEN  
145 mm  
Directors



**02-3966**  
NELATON  
160 mm  
Directors



**02-3967**  
Director with tip  
Diam. Of tip 3,3 mm  
140 mm



**02-3968**  
BRODIE  
Director with tip,  
Diam. Of tip 3,5 mm  
200 mm



**02-3969**  
LOCKHART-MUMMERY  
165 mm  
Straight



**02-3970**  
LOCKHART-MUMMERY  
165 mm  
45° Curved



**02-3971**  
LOCKHART-MUMMERY  
165 mm  
90° Curved



**02-3972**  
LOCKHART-MUMMERY  
165 mm  
Retrograde Curved



**02-3973**  
Director with wire  
loop, malleable  
190 mm



# Probes

**02-3974**  
2,5 mm  $\varnothing$   
**02-3975**  
2,5 mm  $\varnothing$   
**02-3976**  
3,0 mm  $\varnothing$



1/2

**02-3974 - 02-3976**  
**02-3974** 145 mm  
**02-3975** 160 mm  
**02-3976** 200 mm  
Probes with eye

1,5 mm  $\varnothing$



1/2

**02-3977**  
Myrtle leaf probe  
145 mm

2,0 mm  $\varnothing$



1/2

**02-3978 - 02-3982**  
Myrtle leaf probe  
**02-3978** 130 mm  
**02-3979** 145 mm  
**02-3980** 160 mm  
**02-3981** 180 mm  
**02-3982** 200 mm



1/2

**02-3983**  
Probes

diam. of tips			length
1 mm	1,5 mm	2 mm	
-	<b>02-3984</b>	-	145mm
<b>02-3985</b>	<b>02-3986</b>	<b>02-3991</b>	145mm
-	<b>02-3987</b>	<b>02-3992</b>	145mm
-	<b>02-3988</b>	<b>02-3993</b>	145mm
-	<b>02-3989</b>	<b>02-3994</b>	145mm
-	<b>02-3990</b>	-	145mm
-	-	<b>02-3995</b>	145mm



AllWell Instruments co.

The name of Health Care Instruments



1/2

**02-3996**  
Double ended probe,  
malleable, diam. of tips  
3 mm with hole  
190 mm



1/2

**02-3997**  
250mm 300mm  
Double ended probes,  
tin, malleable, diam. of tips  
3,5 mm with hole



1/4

**02-3998**  
Double ended probe,  
tin, malleable,  
diam. of tips 4 mm  
400 mm



1/2

$\varnothing$  tip  
**02-3999 - 02-4001**  
**02-3999** 1,5 mm  
**02-4000** 2,0 mm  
**02-4001** 2,5 mm  
300 mm Probes

## Probes - Spatulas - Cotton Applicators



**02-4002**  
STACKE  
Silver  
100 mm  
∅ 0.8mm



**02-4003**  
KILLIAN  
165 mm  
∅ 1.5mm



**02-4004**  
160 mm  
∅ 1.4mm



**02-4005**  
SEIFFERT  
Silver  
180 mm  
∅ 0.5mm



**02-4006**  
BOWMAN  
130 mm

German Silver

- 02-4007 - 02-4011**  
**02-4007** 0.7+0.8mm ∅ Fig. 00/0  
**02-4008** 0.9+1.1mm ∅ Fig. 1/2  
**02-4009** 1.3+1.4mm ∅ Fig. 3/4  
**02-4010** 1.5+1.6mm ∅ Fig. 5/6  
**02-4011** 1.8+1.9mm ∅ Fig. 7/8



**02-4012**  
SPATULA  
145 mm



**02-4013**  
SPATULA  
145 mm



**02-4014**  
Modell PICCOLO  
Round Serrated end  
110 mm 0.7mm



**02-4015**  
Modell PICCOLO  
Triangular Serrated end  
110 mm 0.7mm













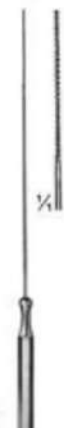



**02-4016**  
FARRELL  
Round Serrated end  
110 mm 1.2mm



**02-4017**  
LATHBURY-FARRELL  
Triangular Serrated end  
110 mm 1.4mm

AllWell Instruments co.  
The name of Health Care Instruments

# Cotton Applicators

 <p><b>02-4018</b> BUCK Rough, spiral end ∅120 mm 0.9mm</p>	 <p><b>02-4019</b> Triangular serrated end ∅140 mm 0.9mm</p>	 <p><b>02-4020</b> Rough, spiral end ∅140 mm 1.0mm</p>	 <p><b>02-4021</b> Rough, spiral end ∅140 mm 1.2mm</p>	 <p><b>02-4022</b> Rough, spiral end ∅140 mm 1.8mm</p>	 <p><b>02-4023</b> FARRELL Round, serrated end ∅140 mm 1.2mm</p>	 <p><b>02-4024</b> LATHBURY-FARRELL Triangular, serrated end 140 mm ∅1.4mm</p> 
 <p><b>02-4025</b> FARRELL Rough, spiral end ∅160 mm 1.2mm</p>	 <p><b>02-4026</b> LATHBURY-FARRELL Triangular, serrated end 160 mm ∅1.2mm</p>	 <p><b>02-4027</b> Triangular, serrated end ∅160 mm 1.4mm</p>	 <p><b>02-4028</b> Rough, spiral end ∅180 mm 1.5mm</p>	 <p><b>02-4029</b> Rough, spiral end ∅180 mm 1.8mm</p>	 <p><b>02-4030</b> Rough, spiral end ∅270 mm 2.5mm</p>	



AllWell Instruments co.  
The name of Health Cure Instruments



# Clip Applying Forceps, Clip Applying - and Removing Forceps



$\frac{1}{2}$   
**02-4031**  
 MICHEL  
 125 mm



$\frac{1}{2}$   
**02-4032**  
 HEGENBARTH  
 120 mm



$\frac{1}{2}$   
**02-4033**  
 WACHENFELDT  
 120 mm



$\frac{1}{2}$   
**02-4034**  
 WACHENFELDT  
 120 mm



$\frac{1}{2}$   
**02-4035**  
 MICHEL  
 125 mm



$\frac{1}{2}$   
**02-4036**  
 MICHEL modif.  
 130 mm



$\frac{1}{2}$   
**02-4037**  
 HEATH  
 135 mm



$\frac{1}{2}$   
**02-4038**  
 COLLIN  
 135 mm

## Suturing Instrument Set, Pocket Instrument Set



### 02-4039

Suturing instruments set, in metal case consisting of:  
 1 michel clip applying and removing forceps,  
 1 Scissors, curved, sharp/sharp, 115mm  
 25 MICHEL clips, 16 x 3mm 1 Delicate tissue forceps, 130mm  
 1 Scalpel, bellied 1 MATHIEU needle holder, 140mm  
 1 Perforated metal case, stainless  
 containing:  
 1 Suture needle  
 1 Suture needle  
 1 Suture needle



### 02-4040

Pocket instrument set, in metal case consisting of:

#### Bottom tray

1 MATHIEU needle holder, 140mm  
 1 MICHEL clip forceps, combined  
 1 Myrtle leaf probe, 130mm  
 1 Sharp double curette  
 1 Skin hook  
 1 Detachable scalpel handle, no.4  
 1 Perforated metal case, containing  
 6 Scalpel blades  
 1 Perforated metal case, stainless, containing  
 1 Suture needle  
 1 Suture needle  
 1 Suture needle

#### Top tray

1 Tissue forceps, 130mm  
 1 KOCHER haemostatic forceps, 130mm  
 1 Straight surgical scissors, 130mm  
 1 Dissecting forceps, 130mm  
 1 FEILCHENFELD splinter forceps, 115mm  
 25 MICHEL clip, 16 x 3mm  
 1 Flacon of suture skin, sterile in alcohol

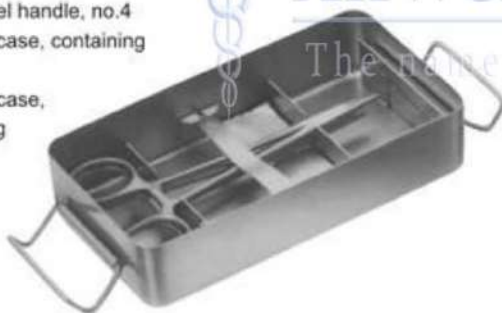

### 02-4041

Pocket instrument set, in metal case consisting of:

#### Bottom tray

1 MAYO-HEGER needle holder, 150mm  
 1 MICHEL clip forceps, combined 1 Myrtle leaf probe, 130mm  
 1 Sharp double curette 1 Skin hook 1 Detachable scalpel handle, no. 4  
 1 Perforated metal case, consisting  
 6 Scalpel blades  
 1 Perforated metal case, stainless, consisting:  
 1 Suture needle  
 1 Suture needle  
 1 Suture needle

#### Top tray

1 Tissue forceps, 130mm  
 1 CRILE haemostatic forceps, 140mm  
 1 Straight surgical scissors, 130mm  
 1 Dissecting forceps, 130mm  
 1 FEILCHENFELD splinter forceps, 115mm  
 25 MICHEL clip, 16 x 3mm  
 1 Flacon of suture silk, sterile in alcohol

**AllWell Instruments co.**  
The name of Health Cure Instruments

## Pocket Instrument Set, Venae Sectio Set

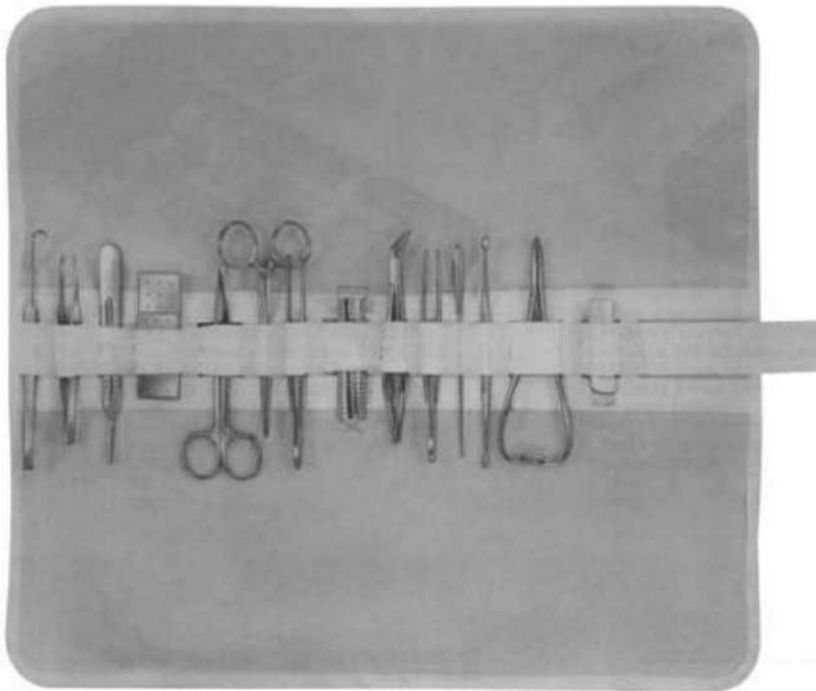

### 02-4042

Pocket instrument set in metal case 170 x 90mm canvas roll only, sterilizable in autoclave, consisting of:

- 1 Myrtle leaf probe, 130mm
- 1 Sharp double curette
- 1 FEILCHENFELD splinter forceps, 115mm
- 1 Dissecting forceps, 130mm
- 1 Tissue forceps, 130mm

- 1 Straight surgical scissors, 130mm
- 1 Scalpel handle no. 4
- 1 Perforated metal case, consisting of 6 scalpel blades
- 1 KOCHER haemostatic forceps, 130mm
- 1 Skin hook
- 1 MATHIEU needle holder, 140mm
- 1 Tube of suture skin, sterile in alcohol
- 1 MICHEL clip forceps, 120mm

- 25 MICHEL clip, 16 x 3mm
- 1 Perforated metal case, stainless, consisting of:
- 1 Suture needle
- 1 Suture needle
- 1 Suture needle

### 02-4043

Canvas roll only, sterilizable in autoclave

Suitable Metal Cases

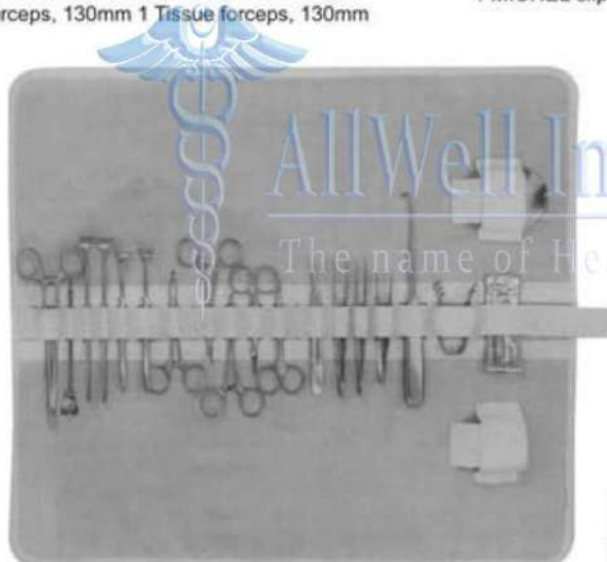

250 x 125 x 55mm



233 x 148 x 57mm

### 02-4044

Venae sectio set, canvas roll only, sterilizable in autoclave, consisting of:

- 2 Tissue forceps, 1 x 2 teeth, 140mm
- 1 Dissecting forceps, 145mm
- 1 FEILCHENFELD splinter forceps, 115mm
- 1 Straight scissors, sharp, 110mm
- 1 Curved scissors, blunt, 115mm
- 3 HALSTED mosquito forceps, curved on flat, 125mm

- 1 DESCHAMPS needle, blunt, 210mm
- 1 DOYEN Director, curved, 140mm
- 2 Wound retractors, 4 blunt prongs, 160mm
- 2 DESMARRES wound retractors, 135mm
- 1 FINSSEN retractors, 2 x3 blunt prongs, 80mm
- 1 Scalpel handle no. 4
- 4 Sterile scalpel blades, no 18, single peel pack
- 1 Needle box, perforated, round, diam. 65mm
- 1 HEGAR-MAYO DUROGRIP needle holder, 180mm

### 02-4045

Canvas roll only, sterilizable in autoclave



## Venae Sectio Set



AllWell Instruments co.  
The name of Health Care Instruments

### 02-4046

Venae sectio set, in metal case

consisting of:

#### Bottom tray

- 1 MATHIEU needle holder, fine pattern 140mm
- 1 Ligature needle, fine short pattern
- 1 DOYEN director, curved
- 1 HEGENBARTH clip forceps,
- 1 ELSCHNIG tissue forceps, 1 x 2 teeth fine, 105mm
- 1 Dressing forceps, fine 105mm
- 1 Tissue forceps, 1 x 2 teeth, 110mm
- 1 Vessel scissors, straight, with 1 ball point, 110mm
- 1 Vessel scissors, curved, pointed 105mm
- 1 FINSSEN retractor
- 1 Perforated needle case

#### Top tray

- 1 Scalpel, pointed
- 1 Scalpel, bellied
- 2 HALSTED mosquito forceps, curved, 125mm
- 2 HALSTED mosquito forceps, straight, 1x 2 teeth, 125mm
- 3 BACKHAUS towel forceps, 90mm
- 2 Flacon holder

## Section - 03



- ★ Hooks, Retractors, Spatulas, Spreaders, Abdoninal Retractors
- ★ Forceps, intestinal Clamps, Specula, Biopsy Forceps, Anuscopes
- ★ Gall Duct Forceps / Probes / Scissors / Kidney Forceps, Urinary Instruments, Trocars

**Pages 115-208**



## Nerve - and Vessel Hooks

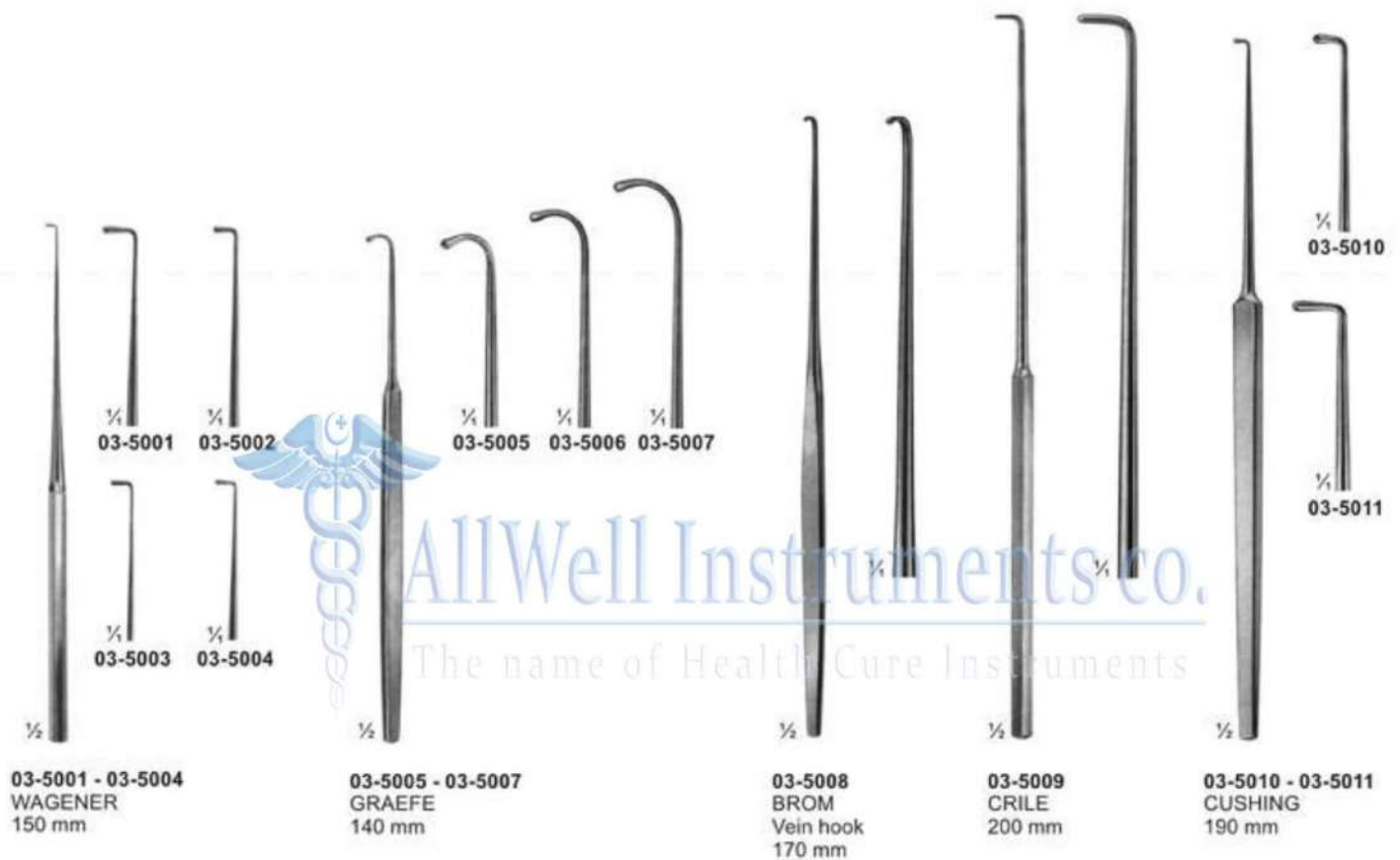



## Nerve - and Vessel Hooks



## Fine Wound Retractors (Dura- and Skin Retractors)

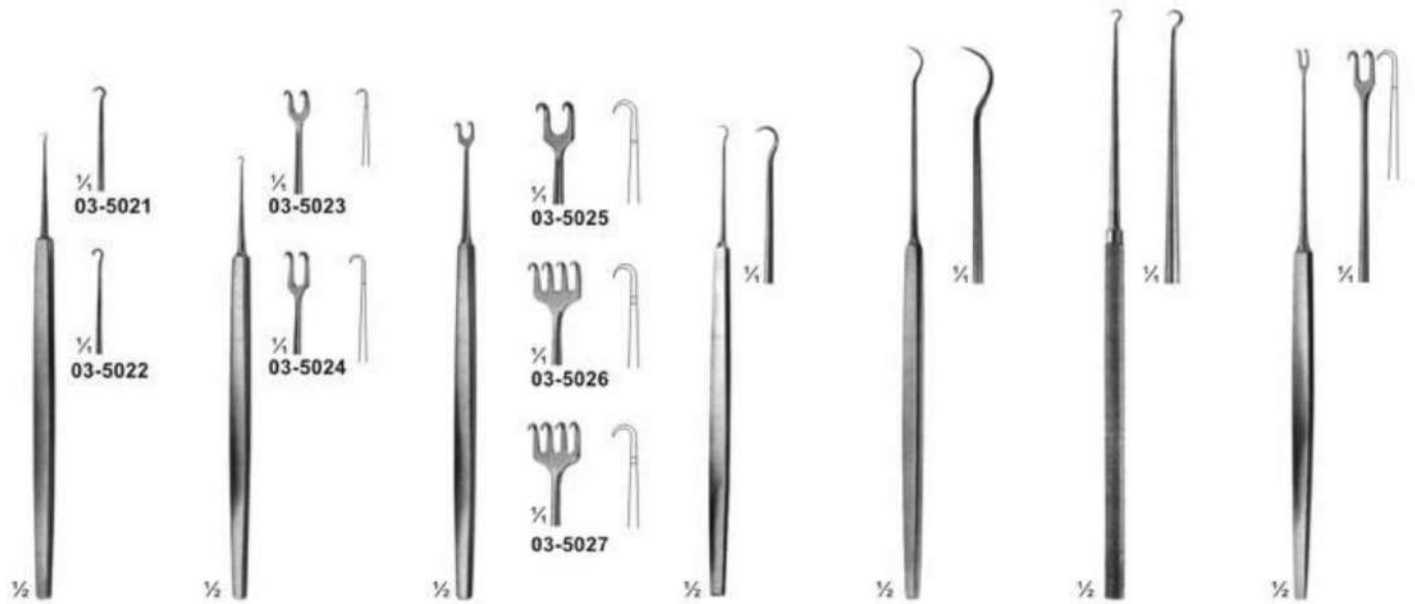

**03-5021 - 03-5022**  
03-5021 Sharp  
03-5022 Blunt  
GRAEFE  
125 mm

**03-5023 - 03-5024**  
03-5023 125 mm  
03-5024 130 mm  
Sharp  
GUTHRIE

**03-5025 - 03-5027**  
03-5025 130 mm  
03-5026 135 mm  
Sharp  
03-5027 135 mm  
Blunt  
ROLLET

**03-5028**  
FRAZIER  
Dura Retractor  
130 mm

**03-5029**  
TOENNIS  
Dura Retractor  
150 mm

**03-5030**  
KILNER  
160 mm

**03-5031**  
FREER  
150 mm



**03-5032**  
MULLER  
150 mm

**03-5033**  
MULLER  
150 mm

**03-5034**  
COTTLE  
160 mm

**03-5035**  
COTTLE  
160 mm

**03-5036**  
JAEGER  
135 mm

**03-5037 - 03-5040**  
JOSEPH  
165 mm

**03-5041 - 5042**  
GILLIES  
180 mm

**03-5043**  
KILNER  
Sharp  
80 mm

**03-5044**  
CONVERSE  
Blunt  
120 mm

## Wound - Trachea Retractors

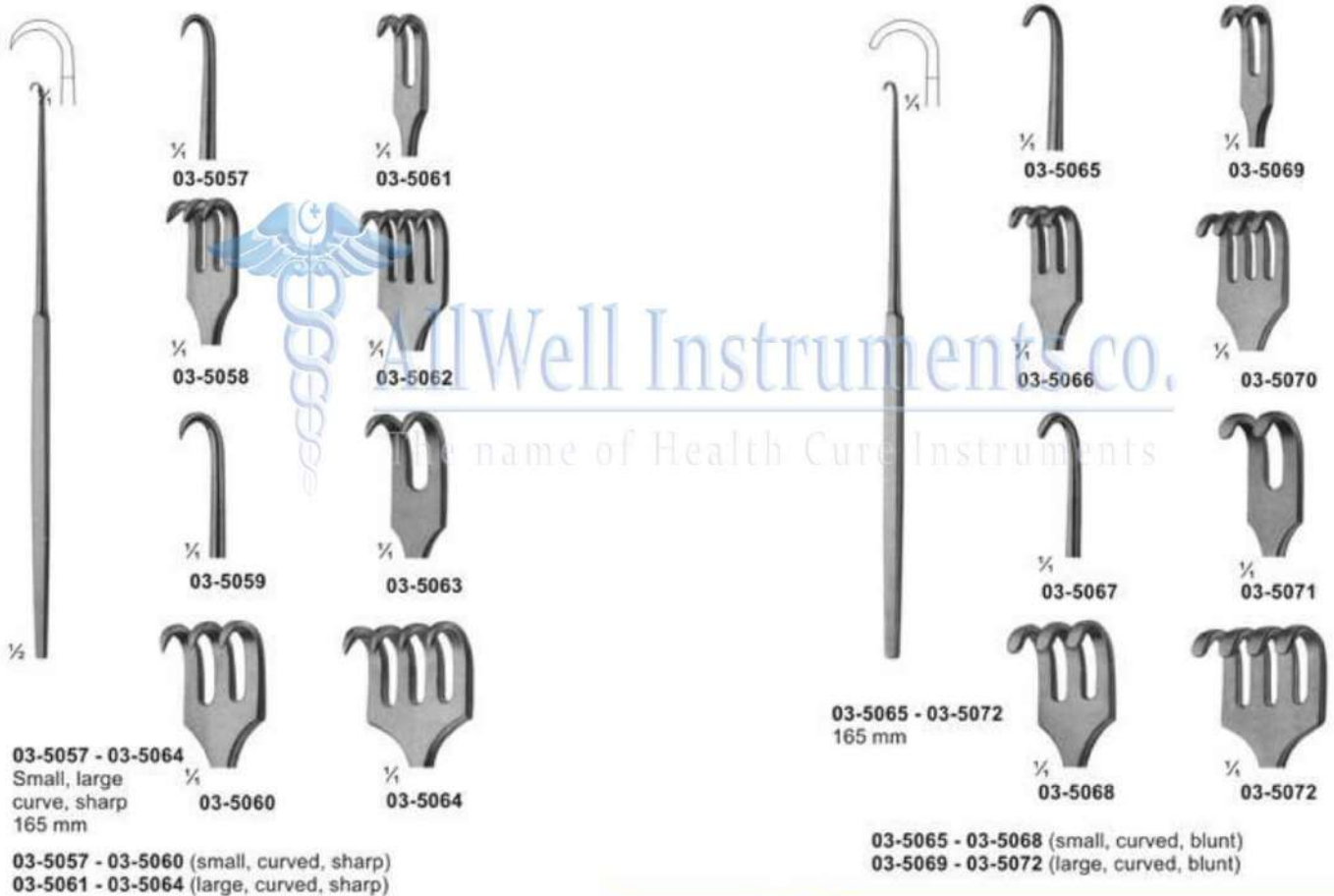



## Retractors With Treangle Handle

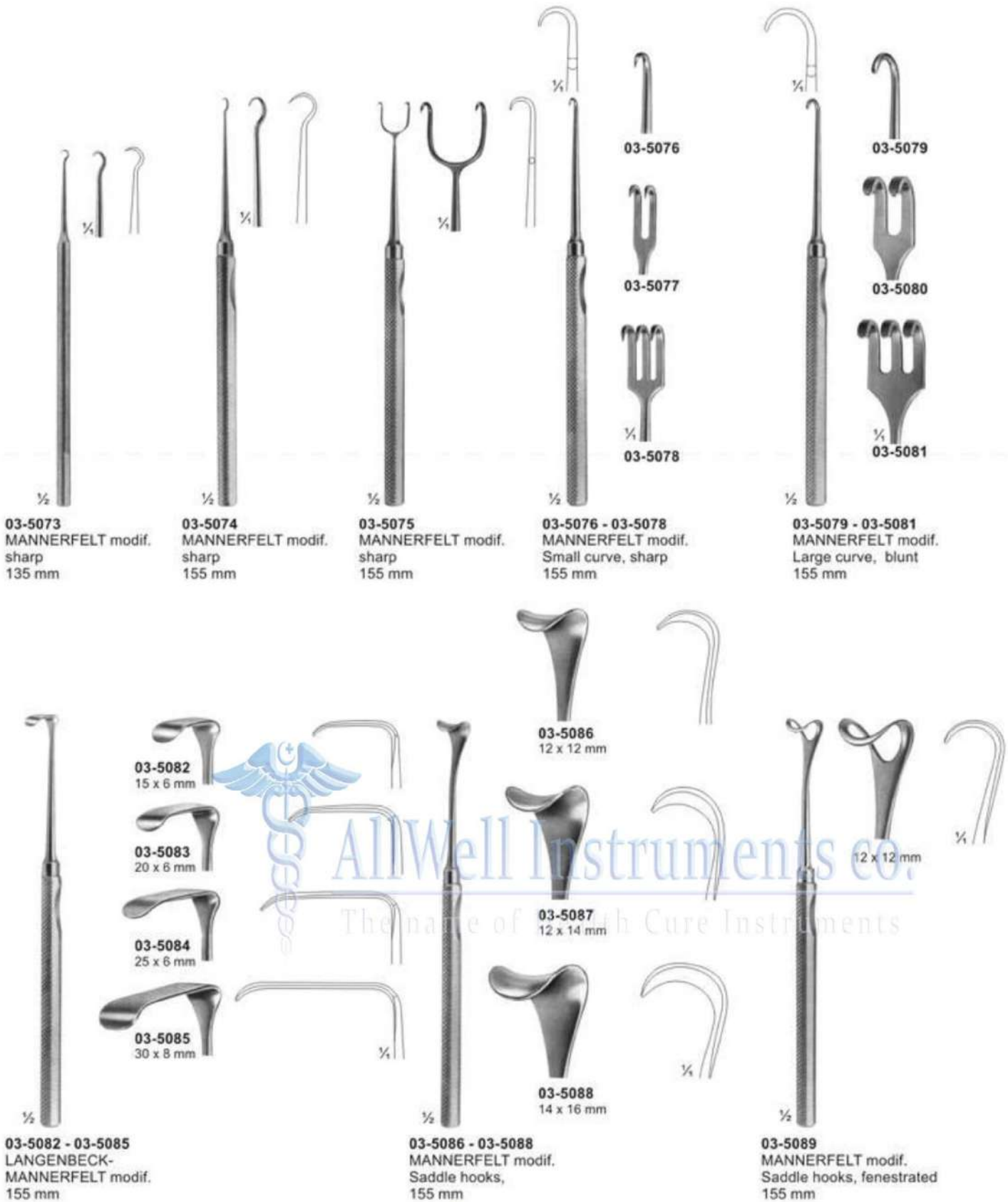

**03-5073**  
MANNERFELT modif.  
sharp  
135 mm

**03-5074**  
MANNERFELT modif.  
sharp  
155 mm

**03-5075**  
MANNERFELT modif.  
sharp  
155 mm

**03-5076 - 03-5078**  
MANNERFELT modif.  
Small curve, sharp  
155 mm

**03-5079 - 03-5081**  
MANNERFELT modif.  
Large curve, blunt  
155 mm

**03-5082**  
15 x 6 mm

**03-5083**  
20 x 6 mm

**03-5084**  
25 x 6 mm

**03-5085**  
30 x 8 mm

**03-5086**  
12 x 12 mm

12 x 12 mm

**03-5087**  
12 x 14 mm

**03-5088**  
14 x 16 mm

**03-5082 - 03-5085**  
LANGENBECK-  
MANNERFELT modif.  
155 mm

**03-5086 - 03-5088**  
MANNERFELT modif.  
Saddle hooks,  
155 mm

**03-5089**  
MANNERFELT modif.  
Saddle hooks, fenestrated  
155 mm

## Retractors

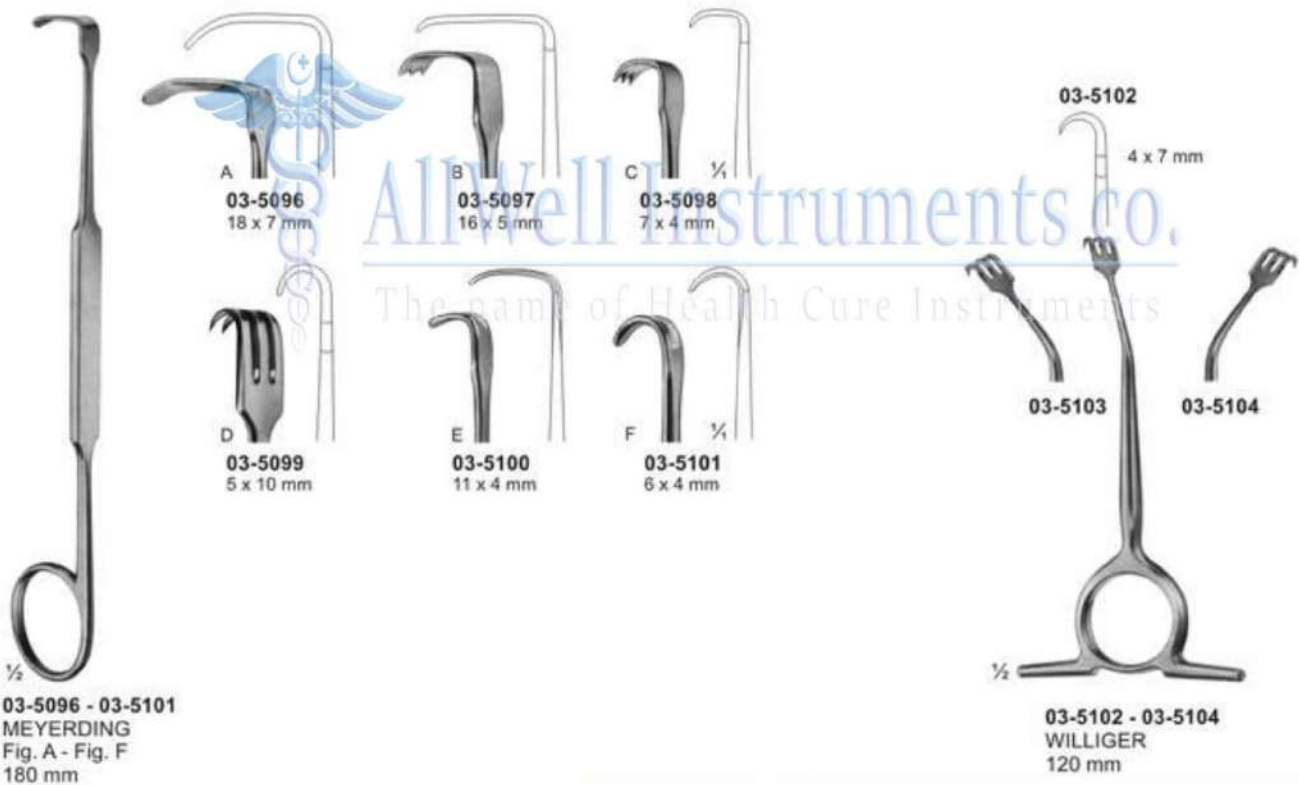

# Retractors



**03-5105**  
EMMET  
Fistula hook  
220 mm



**03-5106**  
SIMON  
Fistula hook  
220 mm



**03-5107**  
SIMON  
Fistula hook  
220 mm



**03-5108**  
LANGE  
Fistula hook  
230 mm



**03-5109 - 03-5110**  
Tendon hooks  
175 mm



**03-5111**  
KLAPP  
Tendon hooks  
175 mm

**AllWell Instruments co.**  
The name of Health Care Instruments



# Wound and Vein Retractors



# Retractors



# Retractors

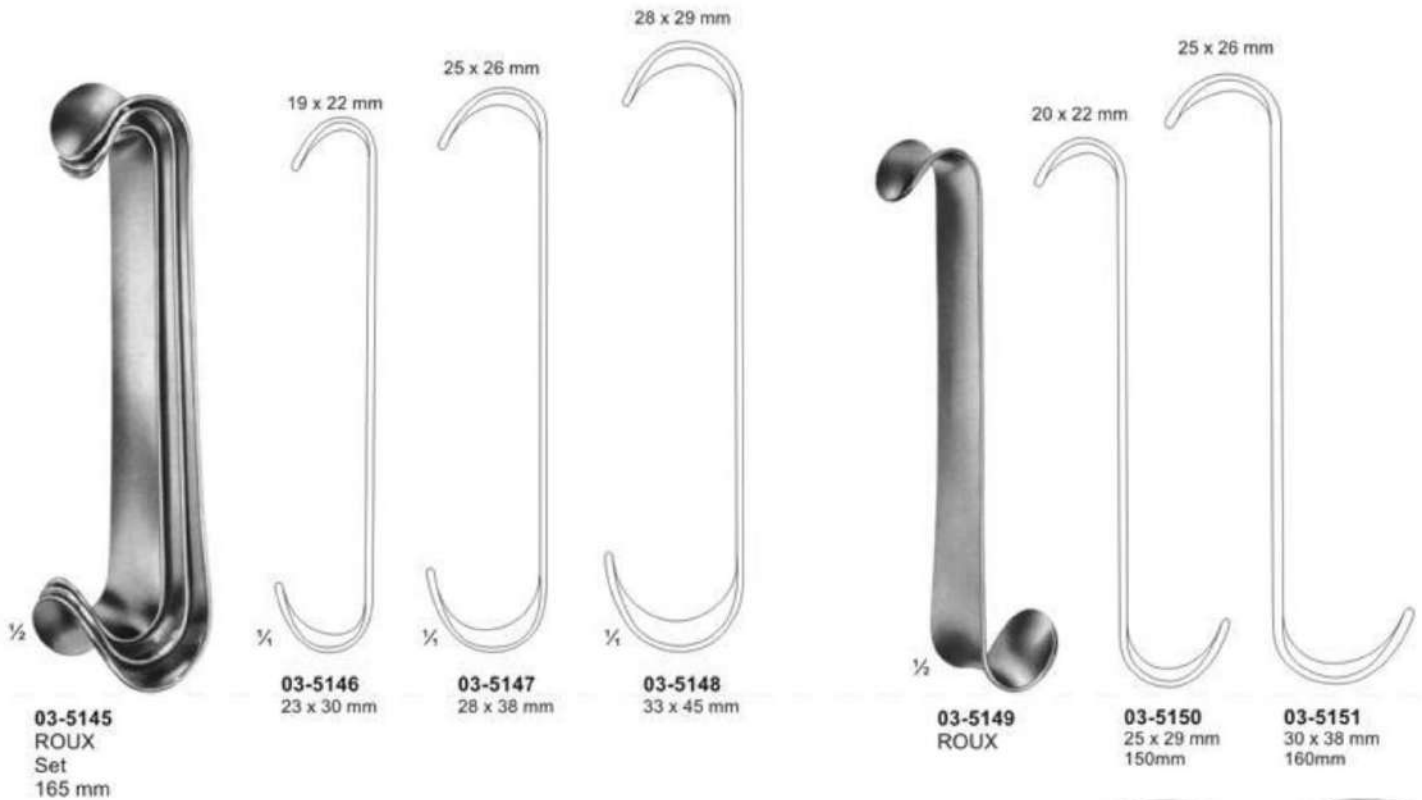

AllWell Instruments co.  
The name of Health Care Instruments



## Bone Retractors and Retractors



**03-5155**  
KOCHER  
Sharp  
205 mm



**03-5156**  
KOCHER  
Sharp  
220 mm



**03-5157**  
VOLKMANN  
Sharp  
220 mm



**03-5158**  
VOLKMANN  
Blunt  
220 mm



**03-5159**  
VOLKMANN  
Sharp  
220 mm



**03-5160 - 03-5167**  
VOLKMANN  
225 mm



**03-5160**  
9 x 8 mm



**03-5161**  
9 x 13 mm



**03-5162**  
9 x 19 mm



**03-5163**  
9 x 29 mm



**03-5164**  
8,5 x 8 mm



**03-5165**  
8,5 x 13 mm



**03-5166**  
8,5 x 19 mm



















**03-5167**  
8,5 x 29 mm

AllWell Instruments co.

# Retractors



 Sharp $\frac{1}{4}$	 <b>03-5168</b> 9 x 8 mm	 <b>03-5169</b> 9 x 13 mm	 <b>03-5170</b> 9 x 19 mm	 <b>03-5171</b> 9 x 29 mm	 <b>03-5172</b> 9 x 40 mm
 Blunt $\frac{1}{4}$	 <b>03-5173</b> 8 x 8 mm	 <b>03-5174</b> 8 x 13 mm	 <b>03-5175</b> 8 x 19 mm	 <b>03-5176</b> 8 x 29 mm	 <b>03-5177</b> 8 x 40 mm
 Semi-Sharp $\frac{1}{4}$	 <b>03-5178</b> 8,5 x 8 mm	 <b>03-5179</b> 8,5 x 13 mm	 <b>03-5180</b> 8,5 x 19 mm	 <b>03-5181</b> 8,5 x 29 mm	

**03-5168 - 03-5181**  
**VOLKMANN**  
 220 mm



 Semi-Sharp $\frac{1}{4}$	 <b>03-5182</b> 16 x 9 mm	 <b>03-5183</b> 16 x 14 mm	 <b>03-5184</b> 16 x 20 mm	 <b>03-5185</b> 16 x 30 mm
 Blunt $\frac{1}{4}$	 <b>03-5186</b> 15,5 x 9 mm	 <b>03-5187</b> 15,5 x 14 mm	 <b>03-5188</b> 15,5 x 20 mm	 <b>03-5189</b> 15,5 x 30 mm

**03-5182 - 03-5189**  
**KOCHER**  
 220 mm

# Retractors, Deep form

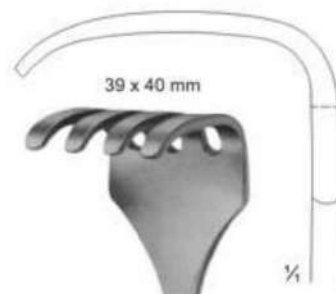

39 x 40 mm

**03-5192**  
4 Prongs, blunt

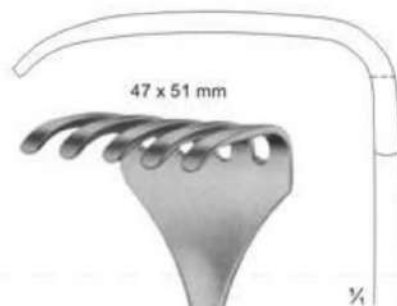

47 x 51 mm

**03-5193**  
5 Prongs, blunt



53 x 62 mm

**03-5194**  
6 Prongs, blunt

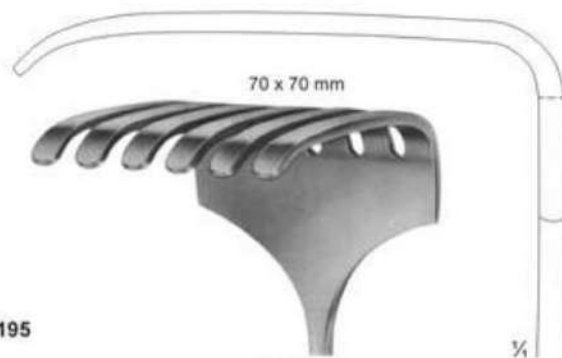

70 x 70 mm

**03-5195**  
6 Prongs, blunt



**03-5190 - 03-5191**  
**KOERTE**  
Handle vertical  
to the blade.  
240 mm



26 x 40 mm

**03-5190**  
8 Prongs, blunt



26.5 x 40 mm

**03-5191**  
8 Prongs, sharp



**03-5192 - 03-5195**  
**ISRAEL**  
255 mm

AllWell Instruments co.  
The name of Health Cure Instruments



# Retractors



**03-5196 - 03-5201**  
**LANGENBECK**  
 210 mm

- 03-5196 28 x 10 mm
- 03-5197 28 x 14 mm
- 03-5198 33 x 14 mm
- 03-5199 28 x 16 mm
- 03-5200 40 x 10 mm
- 03-5201 40 x 13 mm



**03-5202 - 03-5210**  
**KOCHER-LANGENBECK**  
 215 mm

- 03-5202 25 x 6 mm
- 03-5203 35 x 8 mm
- 03-5204 35 x 11 mm
- 03-5205 35 x 15 mm
- 03-5206 41 x 11 mm
- 03-5207 55 x 11 mm
- 03-5208 70 x 14 mm
- 03-5209 80 x 12mm
- 03-5210 80 x 16mm



**03-5211**  
**LANGENBECK**  
 215 mm

Handle vertical to the Blade



# Retractors



1/2

**03-5212 - 03-5216**  
KOCHER  
230 mm



1/2

**03-5217 - 03-5219**  
SAUERBRUCH  
225 mm



**03-5212**  
40 x 18 mm

1/4

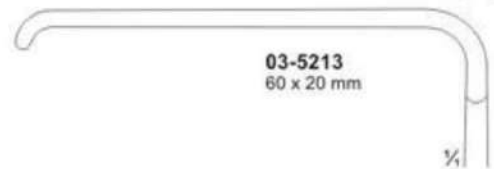

**03-5213**  
60 x 20 mm

1/4



**03-5214**  
60 x 25 mm

1/4

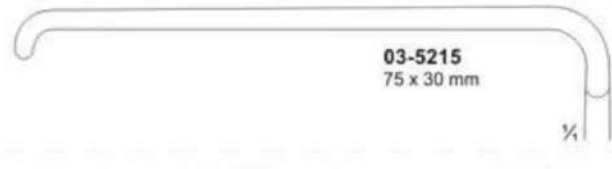

**03-5215**  
75 x 30 mm

1/4



**03-5216**  
75 x 40 mm

1/4

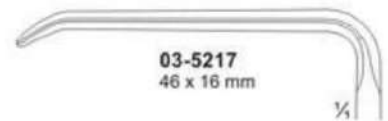

**03-5217**  
46 x 16 mm

1/4



AllWell Instruments Co.

The name of Health Care Instruments



**03-5218**  
55 x 22 mm

1/4



**03-5219**  
72 x 19 mm

1/4

# Retractors

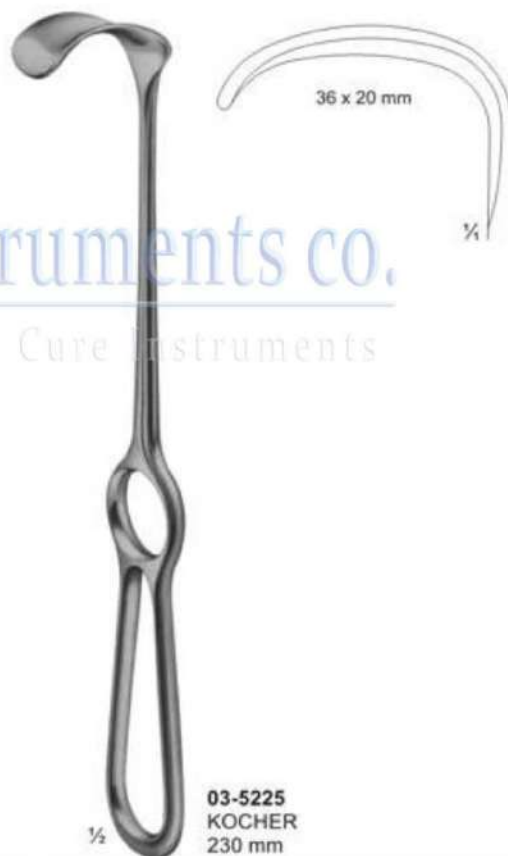

AllWell Instruments co.  
The name of Health Cure Instruments



# Retractors



1/2

**03-5226 - 03-5231**  
HOSEL  
250 mm



**03-5226**  
60 x 20 mm

1/4

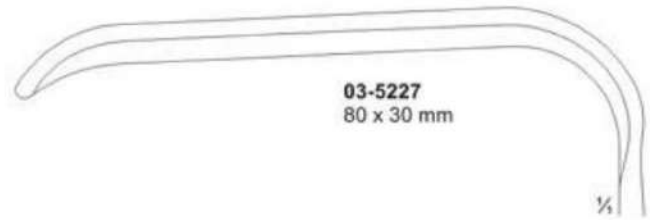

**03-5227**  
80 x 30 mm

1/4

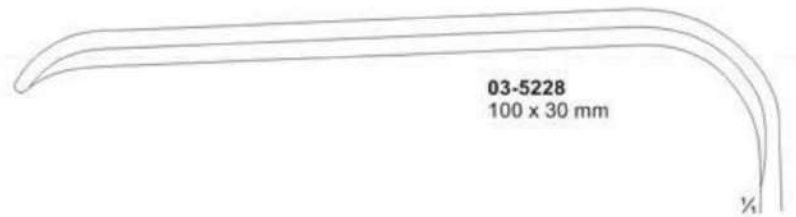

**03-5228**  
100 x 30 mm

1/4



**AllWell Instruments co.**

The name of Health Cure Instruments

**03-5229**  
120 x 30 mm

1/4

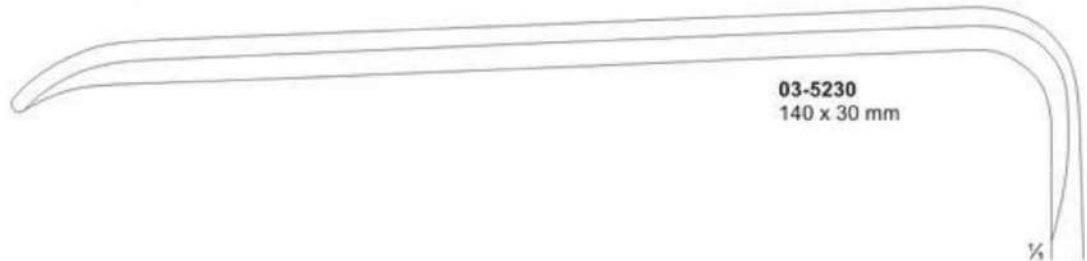

**03-5230**  
140 x 30 mm

1/4

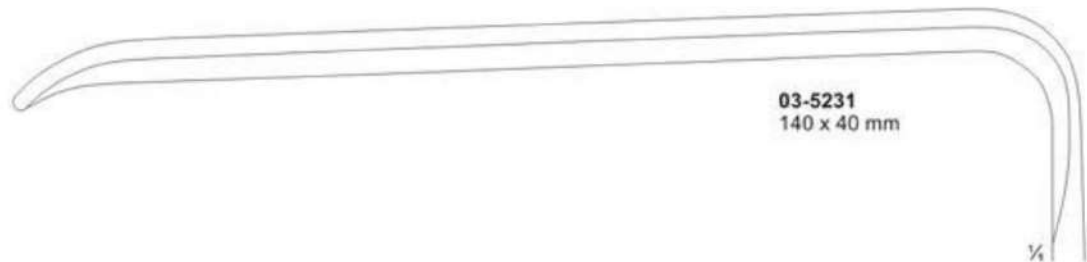

**03-5231**  
140 x 40 mm

1/4

# Retractors

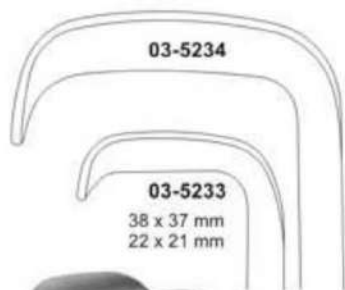

**03-5234**

**03-5233**  
38 x 37 mm  
22 x 21 mm



**03-5235**  
23 x 20 mm



**03-5236**  
30 x 29 mm



**03-5237**  
37 x 37 mm



47 x 21 mm



29 x 30 mm  
64 x 43 mm

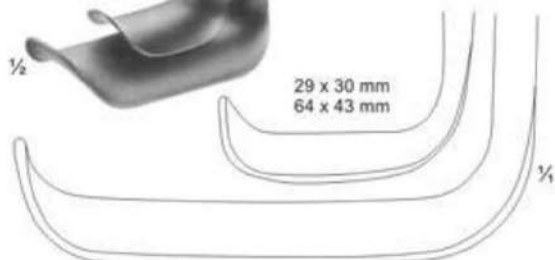

**03-5232**  
RICHARDSON-EASTMAN  
Set  
**03-5232** 250 mm  
**03-5233** 270 mm  
**03-5234**  
Richardson - Eastman  
complete set of 2



**03-5235 - 03-5237**  
RICHARDSON  
240 mm

**03-5238**  
RICHARDSON  
240 mm

**AllWell Instruments co.**  
The name of Health Cure Instruments

# Retractors

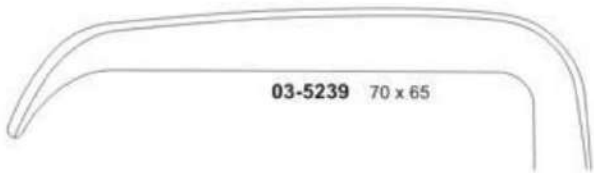

03-5239 70 x 65

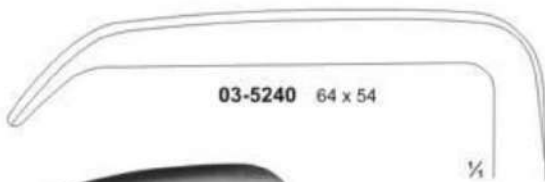

03-5240 64 x 54

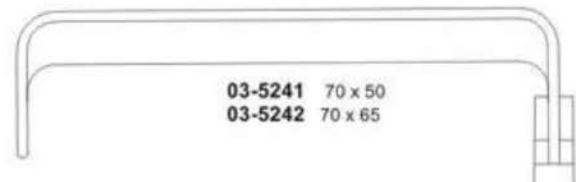

03-5241 70 x 50  
03-5242 70 x 65



½

03-5239 - 03-5240  
KELLY  
260 mm



½

03-5241 - 03-5242  
MORRIS  
245 mm

 AllWell Instruments co.  
 The name of Health Care Instruments



## Retractors For Deep Surgery



 AllWell Instruments co.

The name of Health Cure Instruments

## Retractors For Deep Surgery



**Retractors, Vario Retractor System, Germ. Fed Patent, Germ. Fed. Regd.Des, US-Patent.**

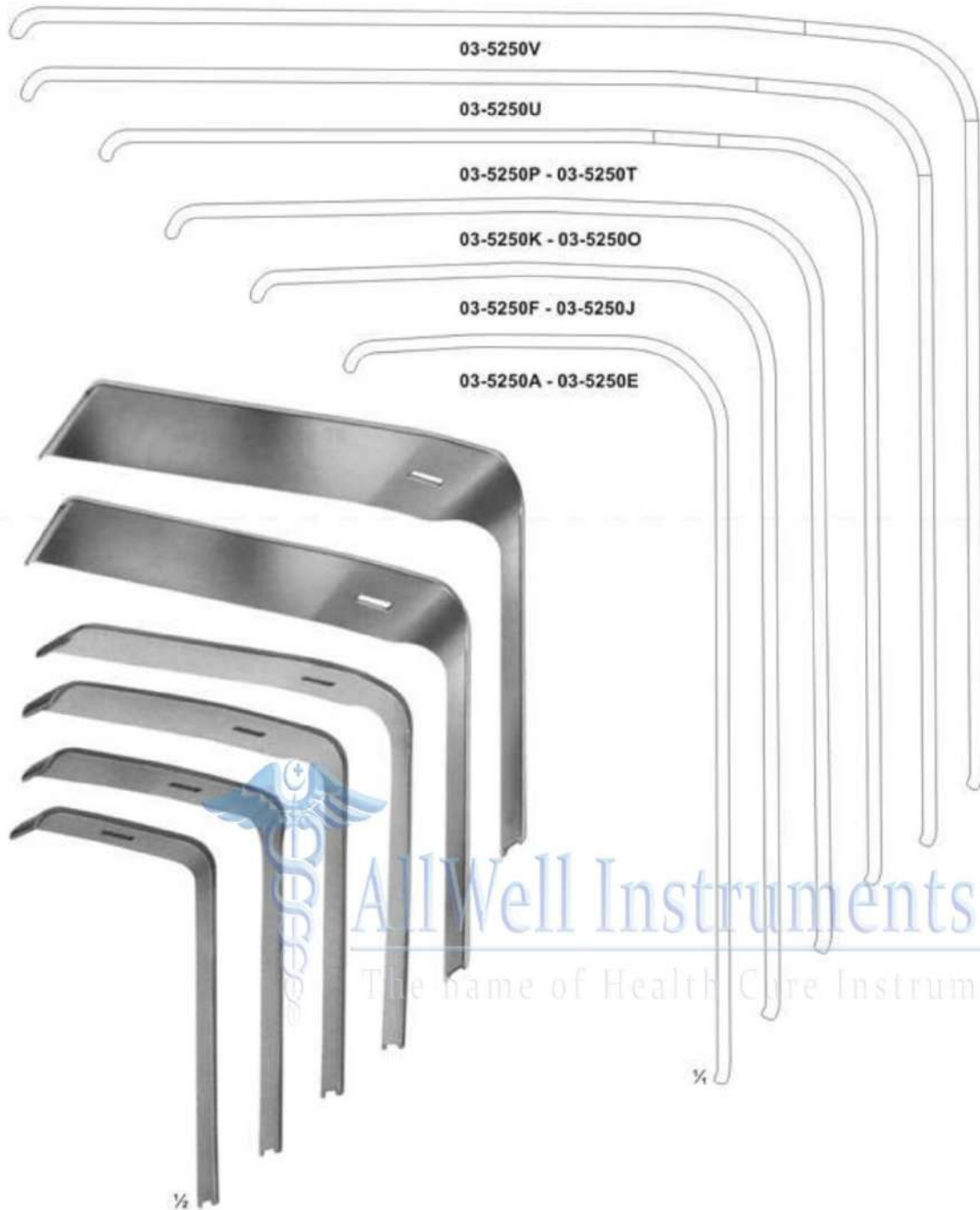

Retractor blades for handles 03-5250

Depth	Width						50mm
	14mm	18mm	22mm	26mm	30mm	40mm	
55mm	03-5250A	03-5250B	03-5250C	03-5250D	03-5250E	-	-
75mm	03-5250F	03-5250G	03-5250H	03-5250I	03-5250J	-	-
95mm	03-5250K	03-5250L	03-5250M	03-5250N	03-5250O	-	-
115mm	03-5250P	03-5250Q	03-5250R	03-5250S	03-5250T	-	-
135mm	-	-	-	-	-	03-5250U	-
145mm	-	-	-	-	-	-	03-5250V



**Retractors, Vario Retractor System, Germ. Fec  
Patent, Germ. Fed. Regd.Des, US-Patent.**



- 03-5251 - 03-5257**  
**BRUNNER**  
275 mm
- |                |          |
|----------------|----------|
| <b>03-5251</b> | 80 x 20  |
| <b>03-5252</b> | 100 x 25 |
| <b>03-5253</b> | 120 x 25 |
| <b>03-5254</b> | 130 x 30 |
| <b>03-5255</b> | 140 x 30 |
| <b>03-5256</b> | 160 x 30 |
| <b>03-5257</b> | 180 x 30 |
- 1/2



- 03-5258**  
Handle with cold  
light carrier for  
retractor blades.  
280 mm



AllWell Instruments co.  
The name of Health Cure Instruments

## Retractors, Lung Spatulas

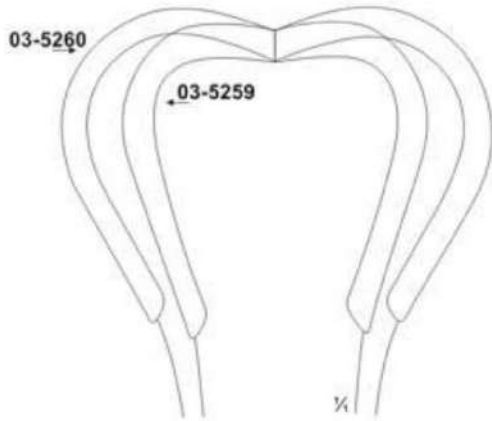

03-5259 - 03-5260  
HARRINGTON  
03-5259 123 x 45 mm  
03-5260 123 x 64 mm  
Flexible  
295 mm



03-5261  
ALLISON  
255 mm



03-5262  
ALLISON  
320 mm

 AllWell Instruments co.  
The name of Health Cure Instruments

# Retractors, Lung Spatulas

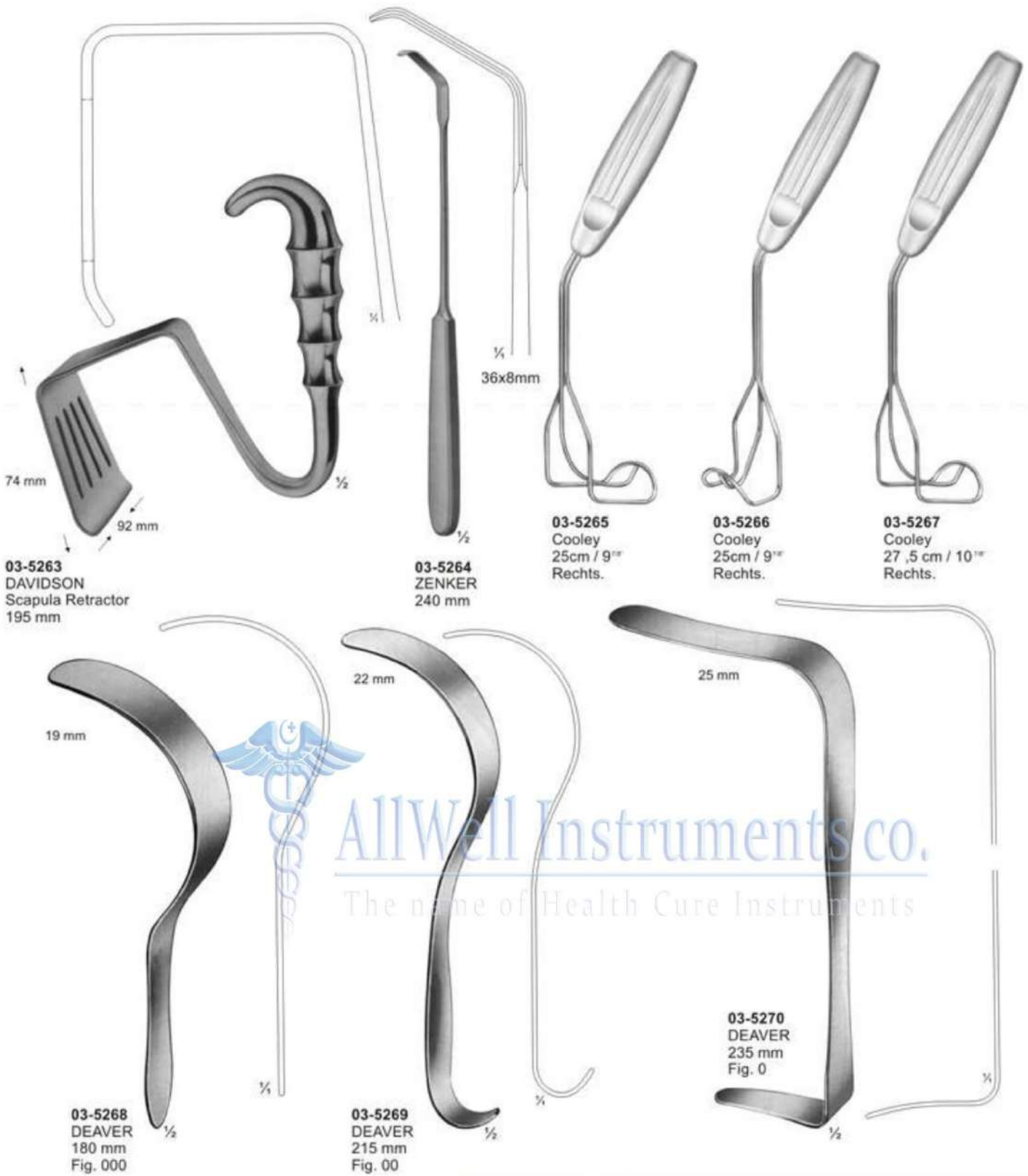

**AllWell Instruments co.**  
The name of Health Cure Instruments



## Retractors, Lung Spatulas



## Retractors, Lung Spatulas



**03-5274**  
DEAVER  
300 mm  
Fig. 3

**03-5275**  
DEAVER  
310 mm  
Fig. 4

**03-5276**  
DEAVER  
320 mm  
Fig. 5

## Retractors, Lung Spatulas



03-5277  
DEAVER  
310 mm  
Fig. 1



03-5278  
DEAVER  
310 mm  
Fig. 3

 AllWell Instruments co.  
The name of Health Care Instruments



## Retractors, Lung Spatulas



03-5279  
DEAVER  
305 mm  
Fig. 4



03-5280  
DEAVER  
310 mm  
Fig. 5

## Retractors For Deep Surgery (Abdominal Retractors)





# Retractors For Deep Surgery (Abdominal Retractors)

03-5285 150 x 39 mm  
03-5286 150 x 57 mm

03-5283 121 x 50 mm  
03-5284 147 x 50 mm

03-5285 - 03-5286  
KELLY  
03-5285 150 x 39 mm  
03-5286 150 x 57 mm  
260 mm

03-5283 - 03-5284  
MIKULICZ  
03-5283 121 x 50 mm  
03-5284 147 x 50 mm  
Liver Retractor  
250 mm

AllWell Instruments co.  
The name of Health Cure Instruments



# Retractors, Abdominal Retractors



Length of Blades	Width of Blades		
	35mm	45mm	60mm
62mm	03-5287	03-5290	03-5294
92mm	03-5288	03-5291	03-5295
122mm	03-5289	03-5292	03-5296
160mm		03-5293	03-5297

# Abdominal Retractors



**03-5304 - 03-5308**  
ROCHARD  
310 mm  
**03-5304** 48 x 90 mm  
**03-5305** 48 x 105 mm  
**03-5306** 48 x 120 mm  
**03-5307** 48 x 135 mm  
**03-5308** 48 x 155 mm



**03-5309**  
ROCHARD  
Fixation device for



**03-5310 - 03-5313**  
DOYEN  
280 mm  
**03-5310** 48 x 90 mm  
**03-5311** 48 x 105 mm  
**03-5312** 48 x 120 mm  
**03-5313** 48 x 135 mm



**03-5314**  
DOYEN-CHILD  
Fixation device  
220 mm



**03-5315**  
Chain  
with weight  
645g  
790 mm

# Pelvis Retractors

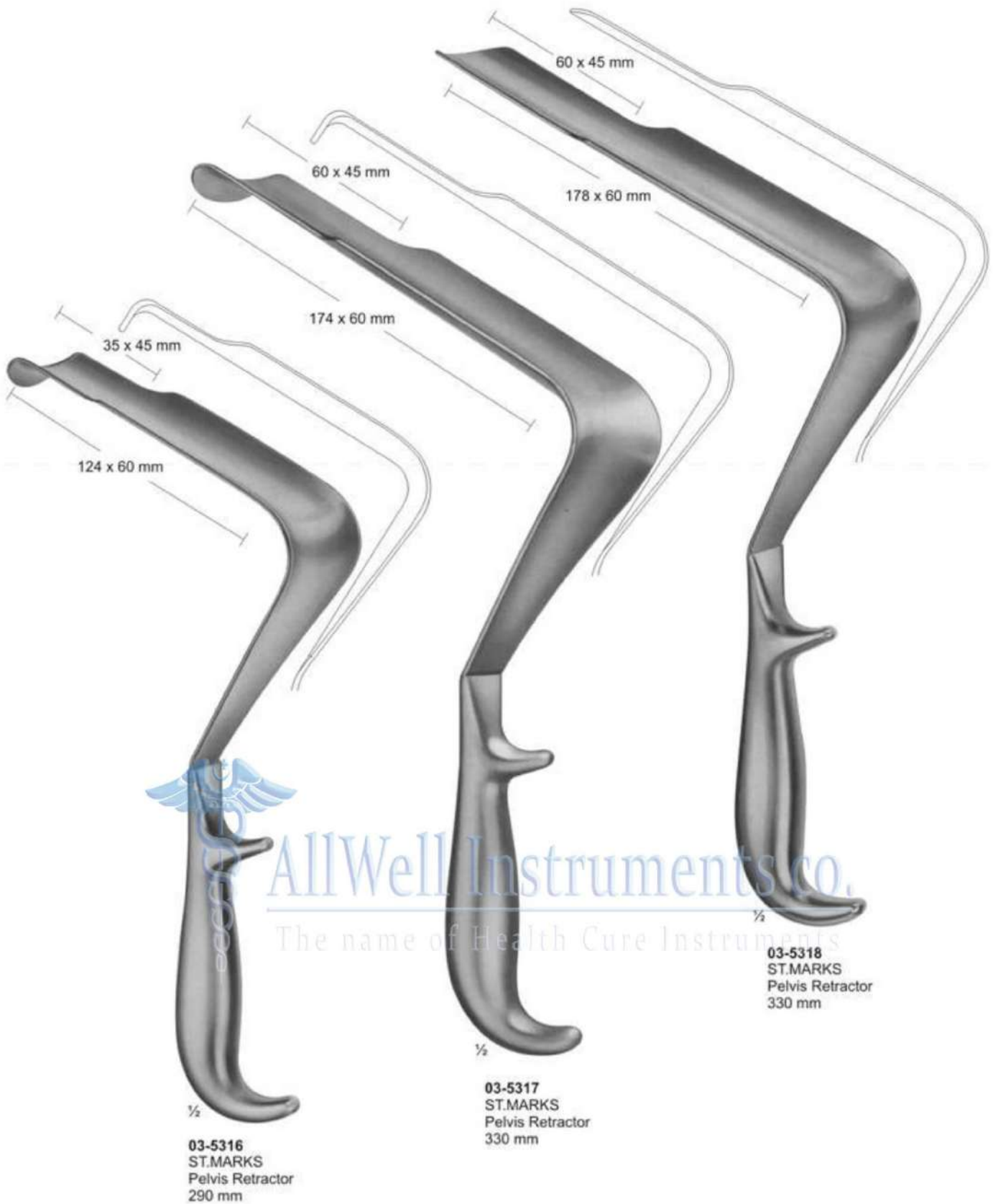

1/2  
**03-5316**  
 ST.MARKS  
 Pelvis Retractor  
 290 mm

1/2  
**03-5317**  
 ST.MARKS  
 Pelvis Retractor  
 330 mm

1/2  
**03-5318**  
 ST.MARKS  
 Pelvis Retractor  
 330 mm



# Abdominal- and Intestinal Spatulas



45 mm

46 mm

½

**03-5319**  
LERICHE  
255 mm

½

**03-5320**  
KUMMEL  
Malleable  
285 mm

½

**03-5321**  
MIKULICZ  
29 mm  
250 mm

½

**03-5322 - 03-5323**  
KADER  
**03-5322** 30 mm  
**03-5323** 40 mm  
270 mm

AllWell Instruments co.  
The name of Health Care Instruments

# Abdominal- and Intestinal Spatulas



**03-5324**  
**REVERDIN**  
285 mm



**03-5325**  
**HABERER**  
Malleable  
305 mm



**03-5326 - 03-5328**  
**03-5326** 30 mm  
**03-5327** 40 mm  
**03-5328** 50 mm  
Malleable  
330 mm



**03-5329**  
**TUFFIER**  
Malleable  
200 mm

AllWell Instruments co.  
The name of Health Cure Instruments

# Self-Retaining Retractors



**03-5330**  
BOSE  
60 mm



**03-5331**  
FINSEN  
50 mm



**03-5332**  
FINSEN  
70 mm



**03-5333**  
FINSEN modif.  
75 mm



**03-5334**  
45 mm



**03-5335**  
55 mm



**03-5336**  
MUELLER  
65 mm



**03-5337**  
100 mm



**03-5338**



**03-5339**



**03-5338 - 03-5339**  
03-5338 70 mm  
03-5339 100 mm



**03-5340**  
LOGAN  
modif. REILL  
50 mm



**03-5341**  
JANSEN  
100 mm



**03-5342**  
JANSEN  
100 mm

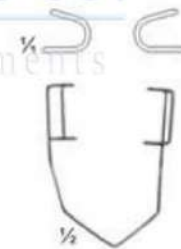

**03-5343**  
BARRAQUER  
45 mm

AllWell Instruments co.  
The name of Health Cure Instruments



## Self-Retaining Retractors



**03-5344**  
**WEITLANER**  
 Sharp  
 110 mm



**03-5345**  
**WEITLANER**  
 Semi-Sharp  
 110 mm



**03-5346**  
**WEITLANER**  
 Blunt  
 110 mm



**03-5347**  
**WEITLANER**  
 Sharp  
 130 mm



**03-5348**  
**WEITLANER**  
 Semi-Sharp  
 130 mm



**03-5349**  
**WEITLANER**  
 Blunt  
 130 mm

**AllWell Instruments co.**  
 The name of Health Cure Instruments

## Self-Retaining Retractors

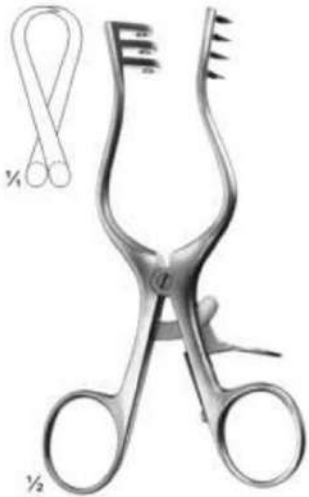

**03-5350**  
**WEITLANER**  
Sharp  
130 mm

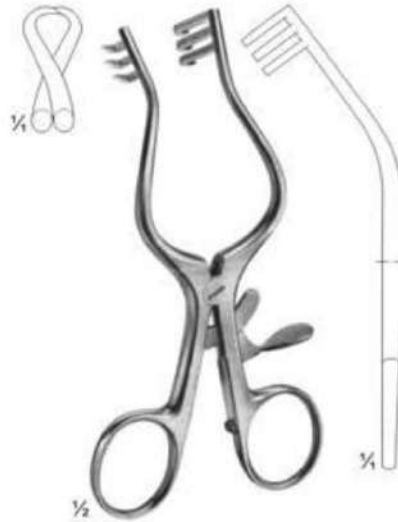

**03-5351**  
**WULLSTEIN**  
Sharp  
130 mm

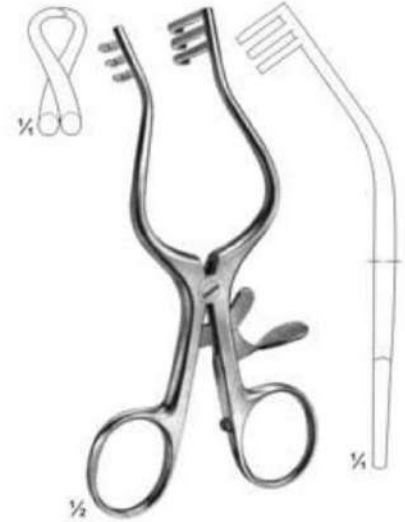

**03-5352**  
**WULLSTEIN**  
Blunt  
130 mm



**03-5353**  
**WEITLANER**  
Sharp  
165 mm



**03-5354**  
**PLESTER**  
Blunt  
110 mm



**03-5355**  
**PERKINS**  
130 mm

## Self-Retaining Retractors



**03-5356**  
ADSON-BABY  
Blunt  
140 mm

**03-5357**  
MOLLISON  
Sharp  
155 mm

**03-5358**  
MAYO-ADAMS  
165 mm



## Self-Retaining Laminectomy Retractors

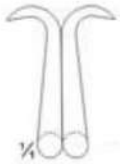

**03-5359**  
**ANDERSON-ADSON**  
 Sharp  
 190 mm

**03-5360**  
**NORFOLK and**  
**NORWICH**  
 Blunt  
 220 mm

**03-5361**  
**ADSON**  
 Sharp  
 265 mm

## Self-Retaining Laminectomy Retractors



¼  
Sharp



¼  
Semi-Sharp



¼  
Semi-Sharp

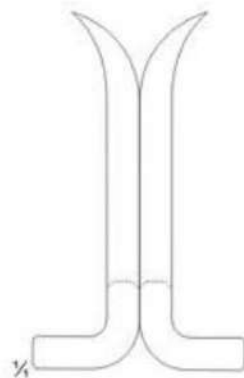

¼



¼

**03-5362 - 03-5363**  
BECKMANN-ADSON  
Sharp  
310 mm



**03-5363**  
BECKMANN-ADSON  
Semi-Sharp  
310 mm



¼

**03-5364**  
ADSON  
Semi-Sharp  
320 mm



¼

**03-5365**  
BECKMANN-EATON  
Sharp  
320 mm

AllWell Instruments Co.

The name of Health Care Instruments

## Special Retractors



½

**03-5366**  
JOLL ( FRIEDMAN )  
Thyroid- and Vaginal Retractor  
155 mm



½

**03-5367**  
JACKSON BURROWS  
Retractor, blunt  
185 mm

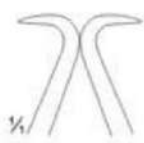

¼



½

**03-5368**  
GELPI  
Vaginal Retractor  
135 mm

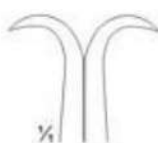

¼



½

**03-5369**  
GELPI  
Skin- and Vaginal Retractor  
175 mm



¼



½

**03-5370**  
DE BAKEY  
Femur Retractor  
145 mm



# Self Retaining Retractors for Laminectomy and other Operations

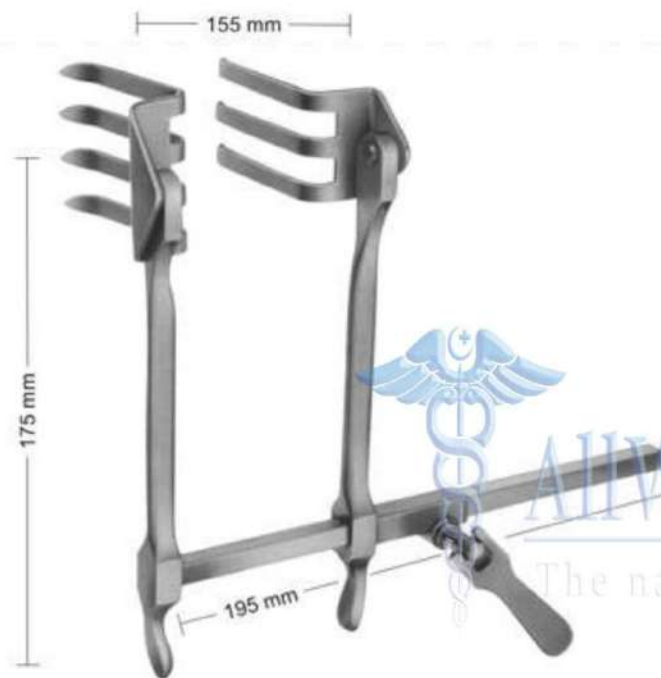

**03-5371**  
SCOVILLE-RICHTER  
Retractor with 1 pair blades reversible type.  
The Retractor bar and shanks may be easily rotated 180° when blades are in situ.



**03-5372**  
62 x 52 mm  
PR= Pair

62 x 37 mm



**03-5373**  
47 x 51 mm



**03-5374**  
30 x 40 mm

**03-5375**  
37 x 62 mm

# Retractors for Cervical Spine



- 03-5376**  
 CLOWARD modif.  
 Spreader Only  
 Consisting of:  
 Spreader Only  
**03-5377** 1 Blade  
**03-5378** 1 Blade  
**03-5379** 1 Blade  
**03-5380** 1 Blade  
**03-5381** 1 Blade

Blades only used for **03-5376**

## Retractors for Cervical Vertebral Column

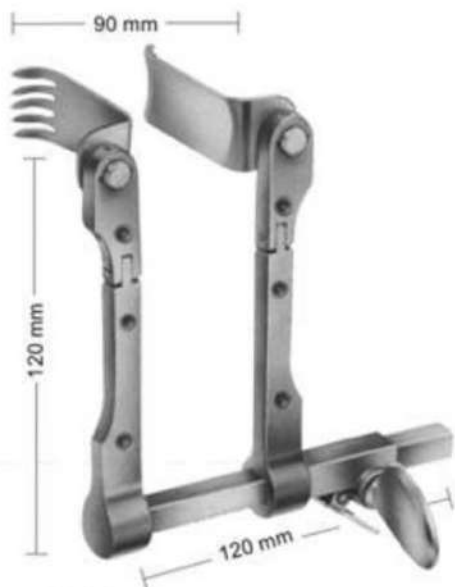

**03-5387**  
**CASPAR**  
Retractor, adjustable, consisting of:  
5 medial blades (03-5389 - 03-5393) 5 Lateral  
blades. (03-5394 - 03-5398) and the retractor  
only By Reversing the Screw,  
The Retractor Can be Used From Both Sides

To be used preferably for transverse retraction.



**03-5388**  
**CASPAR**  
Counter retractor, adjustable,  
consisting of: 5 blades. (03-5399 - 03-5403)  
and the retractor only

To be used preferably for  
up and down retraction.



**03-5389** 40 x 23 mm  
**03-5390** 45 x 23 mm  
**03-5391** 50 x 23 mm  
**03-5392** 55 x 23 mm  
**03-5393** 60 x 23 mm  
Medial blades

**03-5394** 40 x 23 mm  
**03-5395** 45 x 23 mm  
**03-5396** 50 x 23 mm  
**03-5397** 55 x 23 mm  
**03-5398** 60 x 23 mm  
Lateral blades

**03-5399** 45 x 23 mm  
**03-5400** 50 x 23 mm  
**03-5401** 55 x 23 mm  
**03-5402** 60 x 23 mm  
**03-5403** 65 x 23 mm  
Blunt blades

**03-5404** 50 x 25 mm  
**03-5405** 60 x 25 mm  
Blunt blades,  
for harvesting of the  
fusion graft from the  
iliac crest

**03-5406** 40 x 25 mm  
**03-5407** 45 x 25 mm  
**03-5408** 50 x 25 mm  
**03-5409** 55 x 25 mm  
**03-5410** 60 x 25 mm  
Medial Titan blades  
semi transparent to x-ray

**03-5411** 40 x 25 mm  
**03-5412** 45 x 25 mm  
**03-5413** 50 x 25 mm  
**03-5414** 55 x 25 mm  
**03-5415** 60 x 25 mm  
Lateral Titan blades  
semi transparent to x-ray



# Lamina Spreaders



**03-5416**  
**CLOWARD**  
 155 mm



**03-5417**  
**CLOWARD**  
 135 mm



**03-5418**  
**INGE**  
 170 mm

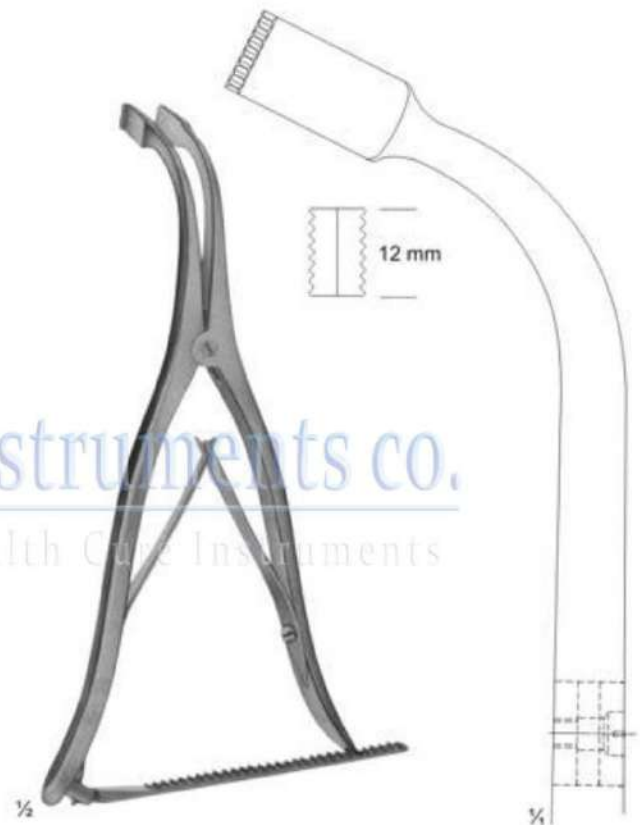

**03-5419**  
**INGE**  
 275 mm

AllWell Instruments co.  
 The name of Health Care Instruments

# Abdominal Retractors



**03-5420**  
**BABY-COLLIN**  
 with 2 pair of blades



**03-5421**  
**COLLIN**  
 complete



**03-5422**  
**COLLIN**  
 complete



**03-5423**  
**RICARD**  
 complete  
 Spreader only  
 Lateral blade  
 Center blade



**03-5424**  
**HOLZBACH**  
 Complete  
 Spreader only  
 Lateral blade 59x80mm  
 Center blade 74x82mm

# Abdominal Baldes



03-5427

Lateral blades only  
03-5425 37x62 mm  
03-5426 37x80 mm  
03-5427 37x98 mm

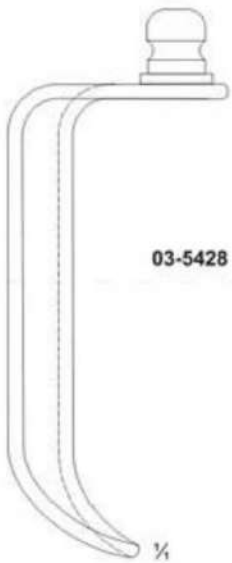

03-5428

03-5428 61x80 mm

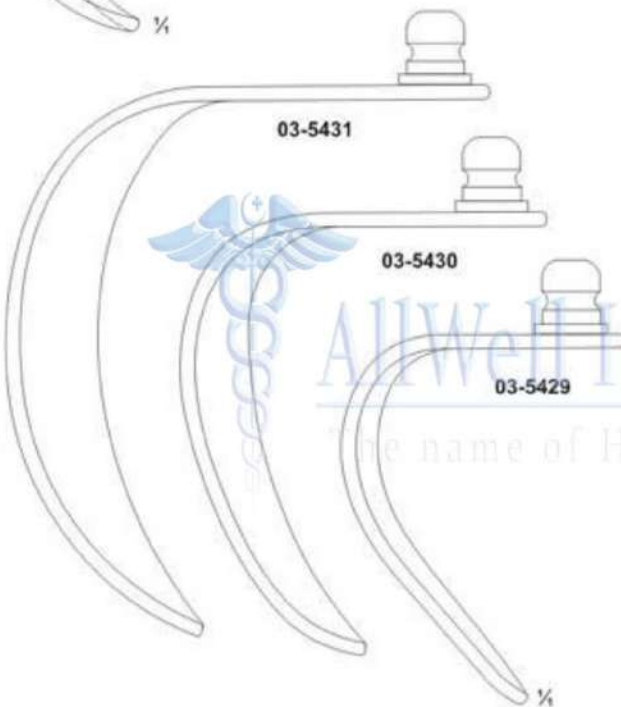

03-5431

03-5430

03-5429

03-5429 48x59 mm  
03-5430 58x80 mm  
03-5431 72x84 mm



03-5432 59x80 mm





# Abdominal Retractors



**03-5433**  
**GOSSET**  
Blades: 38 mm deep

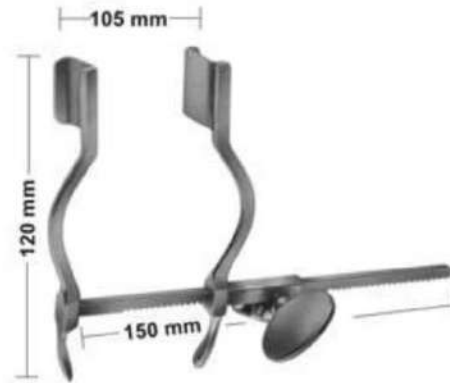

**03-5434**  
**HERTZLER**  
Blades 20 X 25 mm

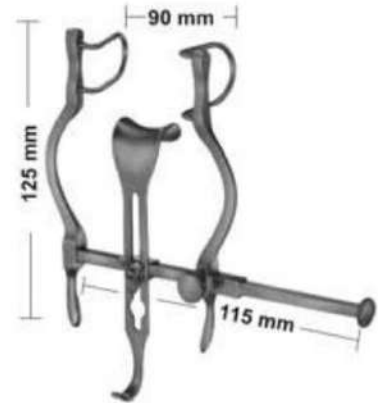

**03-5435**  
**BALFOUR-BABY**  
Lateral blades 27 mm deep  
(03-5435) Center blade 21x24 mm



**03-5436**  
**GOSSET**  
Blades: 55mm deep

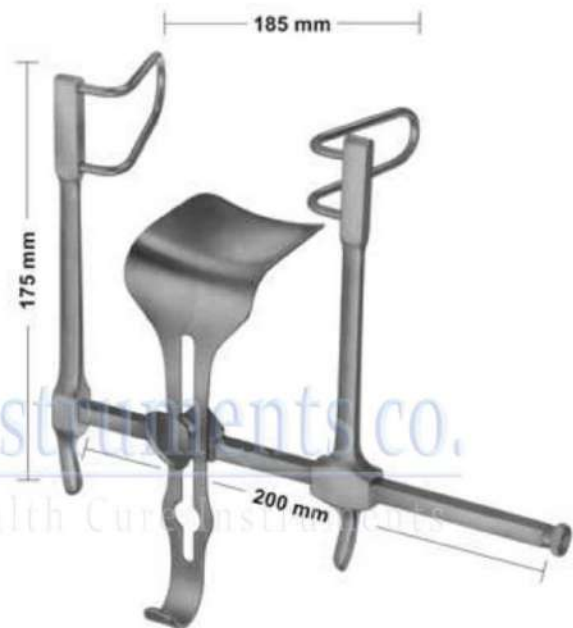

**03-5437**  
**GOSSET**  
Lateral blades 58 mm deep  
Center blade  
59 x 57 mm

# Abdominal Retractors

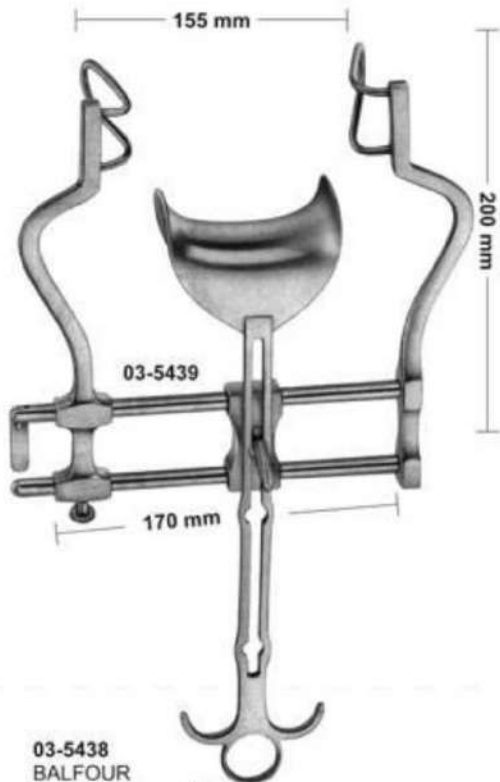

**03-5438**  
BALFOUR  
Lateral blades 60 mm deep  
(03-5439) Center blade  
47 x 80 mm

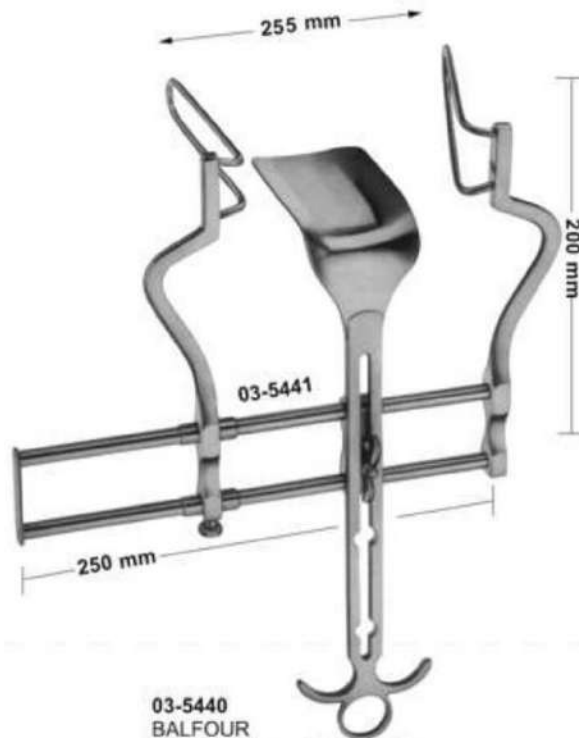

**03-5440**  
BALFOUR  
Lateral blades 105 mm deep  
(03-5441) Center blade  
107x 59 mm



**03-5442**  
Center blade only  
54x80 mm

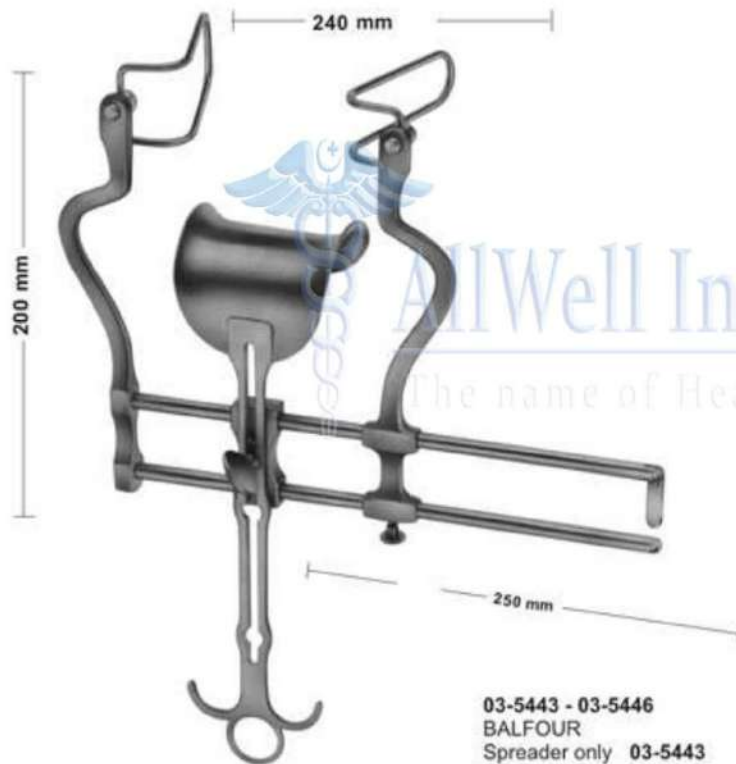

**03-5443 - 03-5446**  
BALFOUR

Spreader only	<b>03-5443</b>	<b>03-5444</b>	<b>03-5445</b>	<b>03-5446</b>
Lateral blades	50 mm	60 mm	75 mm	90 mm
Center blade	47 x 80 mm	62x76 mm	80x80 mm	80x80 mm



Lateral blades  
**03-5447**  
50 mm deep  
**03-5448**  
60 mm deep  
**03-5449**  
75 mm deep  
**03-5450**  
90 mm deep

Sales Unit of blades: PR = pair

**AllWell Instruments Co.**  
The name of Health Cure Instruments

# Abdominal Retractors

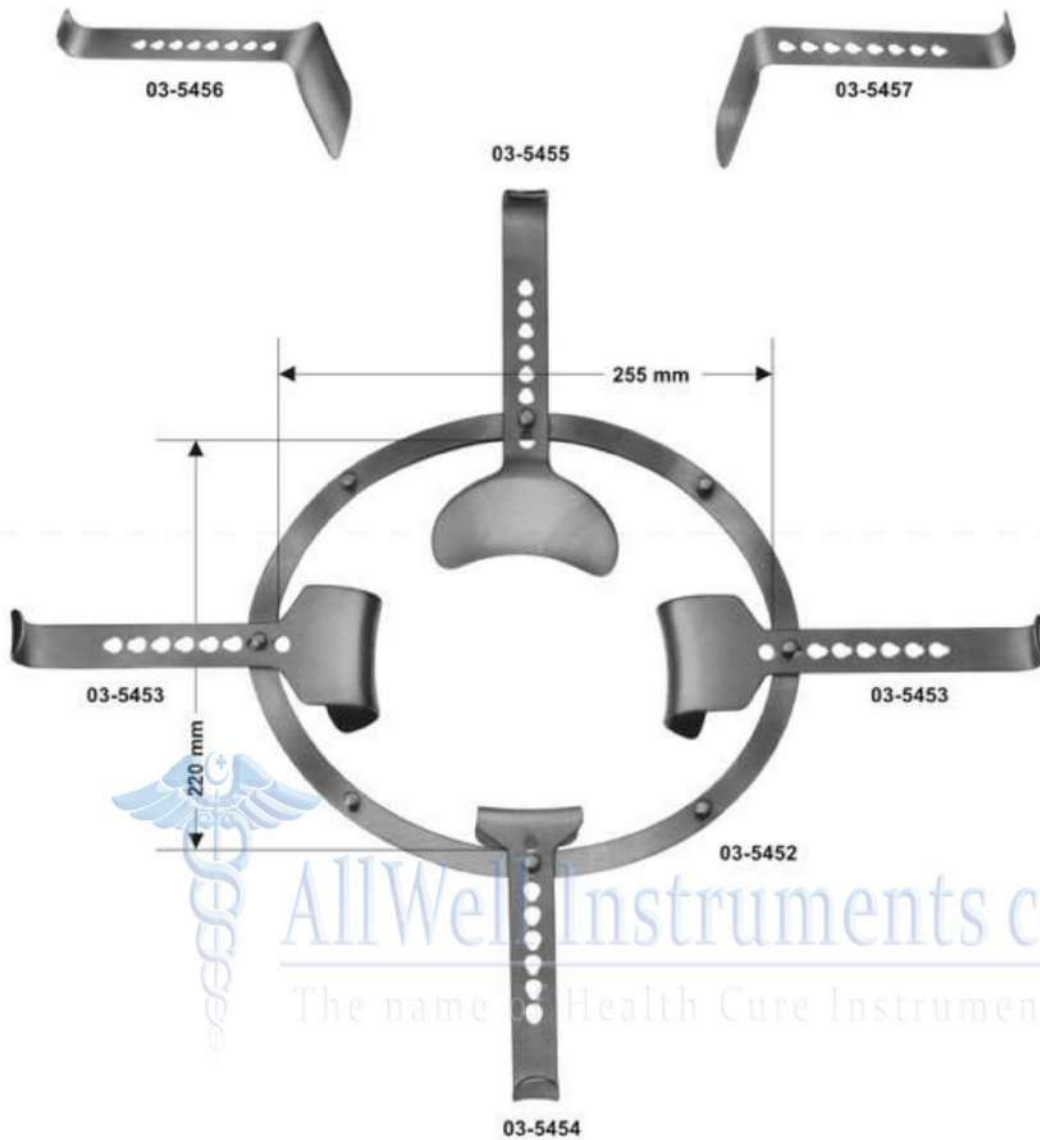



**AllWell Instruments co.**  
 The name of Health Cure Instruments

- 03-5451**  
SEMM
- consisting of:
- 03-5452** 1 frame 225 x 220 mm
- 03-5453** 2 blades 46 x 64 mm
- 03-5454** 1 blade 53 x 54 mm  
(for bladder)
- 03-5455** 1 blade 82 x 97 mm  
(for intestine)
- 03-5456** 1 blade 98 x 51 mm  
(for intestine)
- 03-5457** 1 blade, narrow  
107 x 36 mm

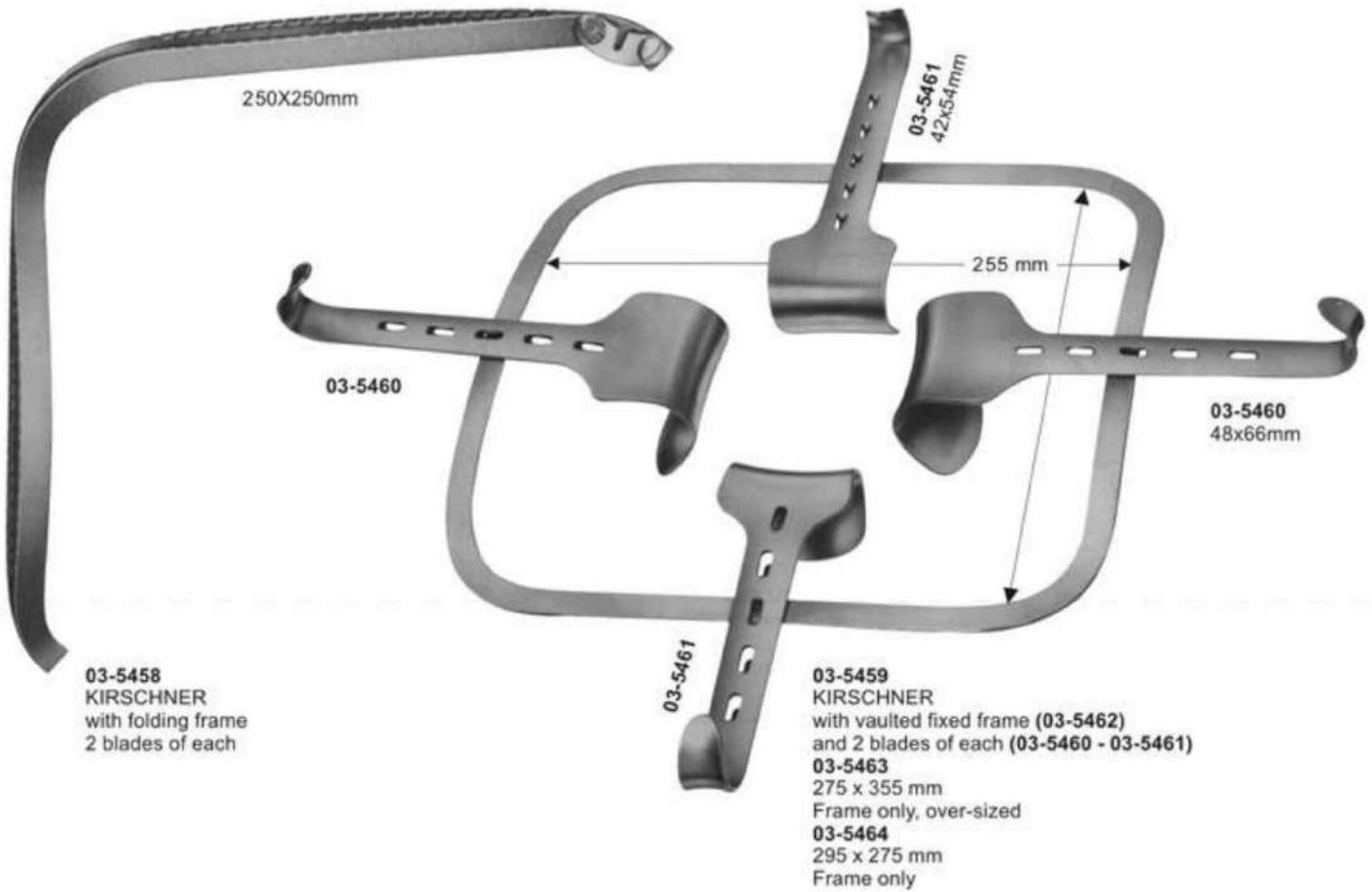

# Abdominal Retractors



**03-5458**  
KIRSCHNER  
with folding frame  
2 blades of each

**03-5459**  
KIRSCHNER  
with vaulted fixed frame (03-5462)  
and 2 blades of each (03-5460 - 03-5461)  
**03-5463**  
275 x 355 mm  
Frame only, over-sized  
**03-5464**  
295 x 275 mm  
Frame only



**03-5465**  
KIRSCHNER  
64 x 80 mm



**03-5466**  
KIRSCHNER-BALFOUR  
80x 82 mm



**03-5467 - 03-5469**  
KIRSCHNER  
**03-5467** 90x 69mm  
**03-5468** 92x 95mm  
**03-5469** 78x 58mm



**03-5470 - 03-5472**  
KIRSCHNER  
**03-5470** 108x42mm  
**03-5471** 91x 55mm  
**03-5472** 121x 55mm

Addition valves for corpulent persons.

## Intestinal and Tissue Grasping Forceps

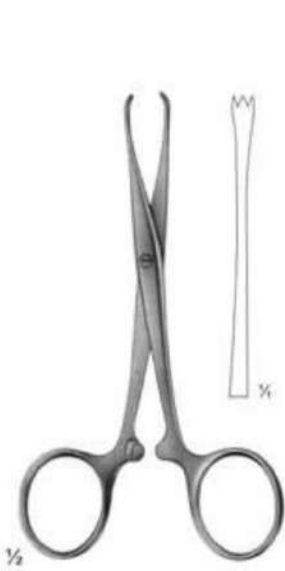

**03-5473**  
CHAPUT  
2 X 3 teeth, sharp  
125 mm,

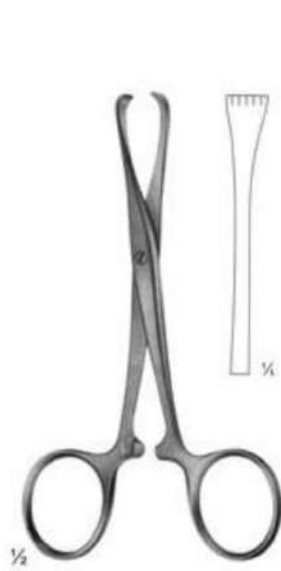

**03-5474**  
TUFFIER  
5 X 6 teeth, sharp  
125 mm,



**03-5475**  
BOYS-ALLIS  
5 X 6 teeth, sharp  
155 mm,

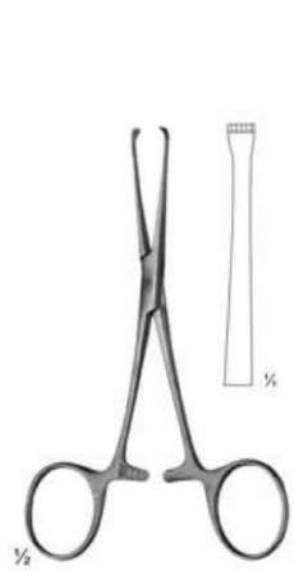

**03-5476**  
BABY-ALLIS  
4 X 5 teeth  
130mm



**03-5477**  
ALLIS  
4 X 5 teeth  
155 mm,



**03-5478**  
ALLIS  
190 mm,  
**03-5479**  
255 mm,  
5 X 6 teeth  
Slender pattern



**03-5480**  
JUDD-ALLIS  
3 X 4 teeth  
195 mm,

# Intestinal Grasping Forceps





# Organ - Tissue Grasping & Intestinal Forceps ATRAUMATA



# Ultra - Light - Forceps, Dissecting Forceps ATRAUMATA



**03-5510** 1,2 mm  
**03-5511** 1,5 mm  
**03-5512** 1,5 mm  
**03-5513** 1,5 mm

- 03-5510 - 03-5513**  
**03-5510** 150 mm  
**03-5511** 200 mm  
**03-5512** 240 mm  
**03-5513** 300 mm



**03-5514** 2 mm  
**03-5515** 2 mm  
**03-5516** 2 mm  
**03-5517** 2 mm

- 03-5514 - 03-5517**  
**DE BAKEY**  
**03-5514** 150 mm  
**03-5515** 200 mm  
**03-5516** 240 mm  
**03-5517** 300 mm



**03-5518** 2,8 mm  
**03-5519** 2,8 mm  
**03-5520** 2,8 mm  
**03-5521** 2,8 mm

- 03-5518 - 03-5521**  
**DE BAKEY**  
**03-5518** 150 mm  
**03-5519** 200 mm  
**03-5520** 240 mm  
**03-5521** 300 mm



**03-5522** 3,3 mm  
**03-5523** 3,5mm  
**03-5524** 3,5mm

- 03-5522 - 03-5524**  
**DE BAKEY**  
**03-5522** 200 mm  
**03-5523** 240 mm  
**03-5524** 300 mm

## Intestinal Clamps for Children

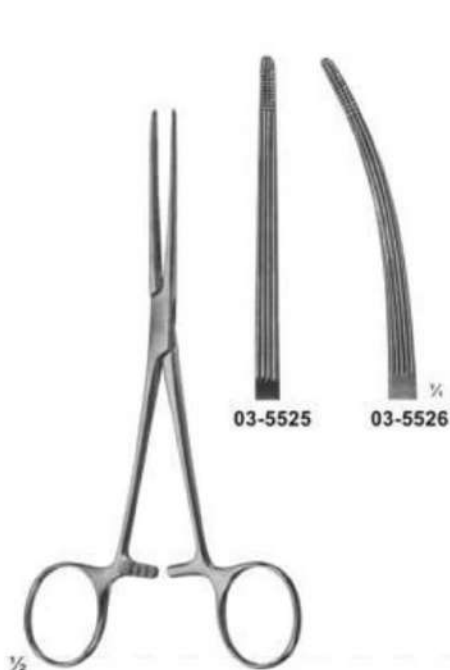

**03-5525 - 03-5526**  
**BAINBRIDGE**  
 155 mm

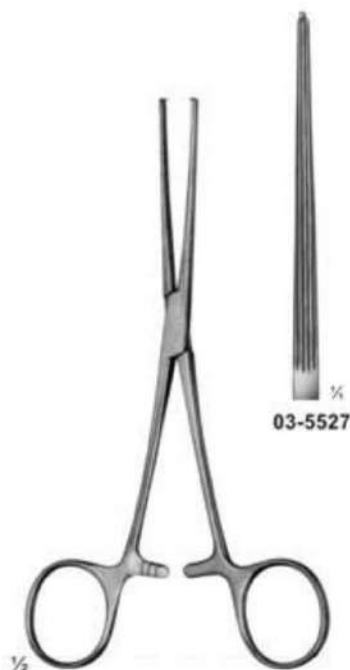

**03-5527**  
**ALLEN**  
 155 mm

### Atraumata



**03-5528 - 03-5529**  
**BABY-KOCHER**  
 very elastic blades  
 130 mm



**03-5530 - 03-5531**  
**BABY-KOCHER**  
 with elastic blades  
 130 mm



# Intestinal Clamps, Soft Elastic

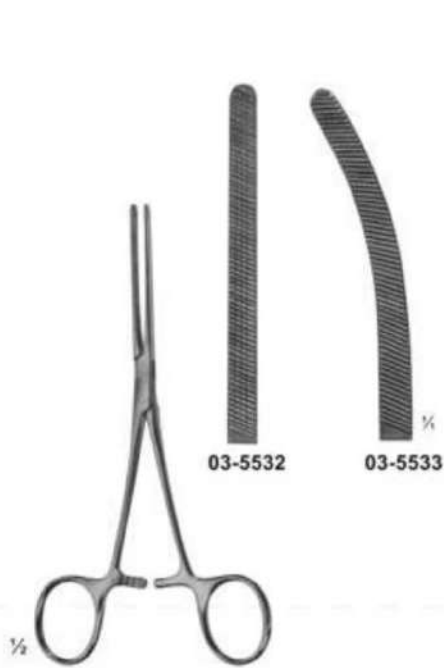

**03-5532 - 03-5533**  
DOYEN  
elastic  
165 mm

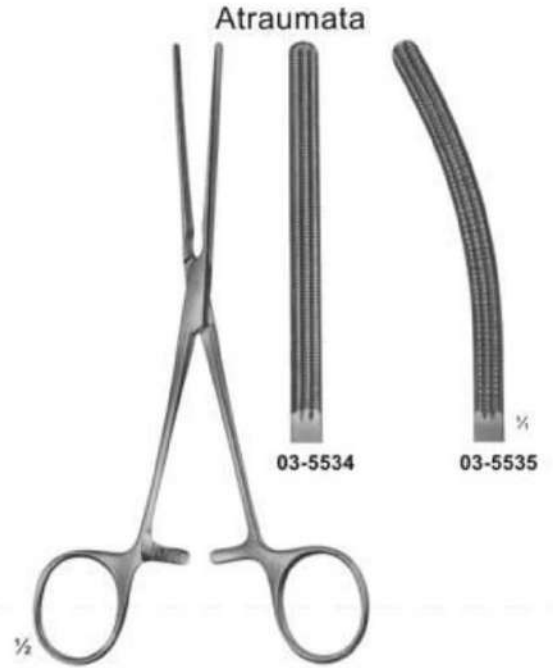

**03-5534 - 03-5535**  
DOYEN  
with elastic blades  
170 mm



**03-5536 - 03-5537**  
HARTMANN  
with elastic blades  
200 mm



**03-5538 - 03-5539**  
HARTMANN  
with elastic blades  
200 mm

# Intestinal Clamps, Soft elastic

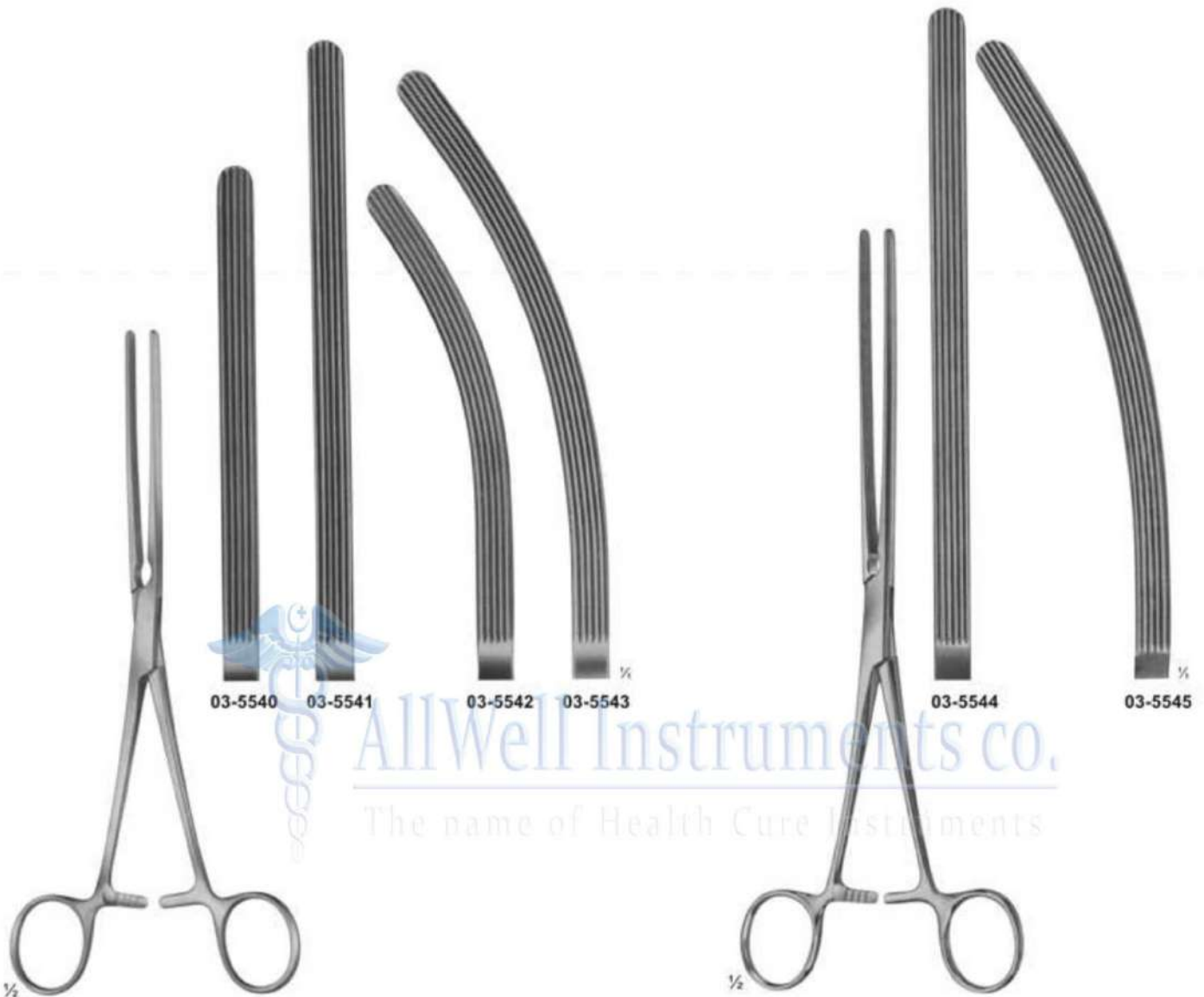

**03-5540 - 03-5543**  
KOCHER  
with elastic blades  
**03-5540-03-5542** 210 mm  
**03-5541-03-5543** 230 mm

**03-5544 - 03-5545**  
DOYEN  
with elastic blades  
240 mm

# Intestinal Clamps, Soft elastic

## Atraumata

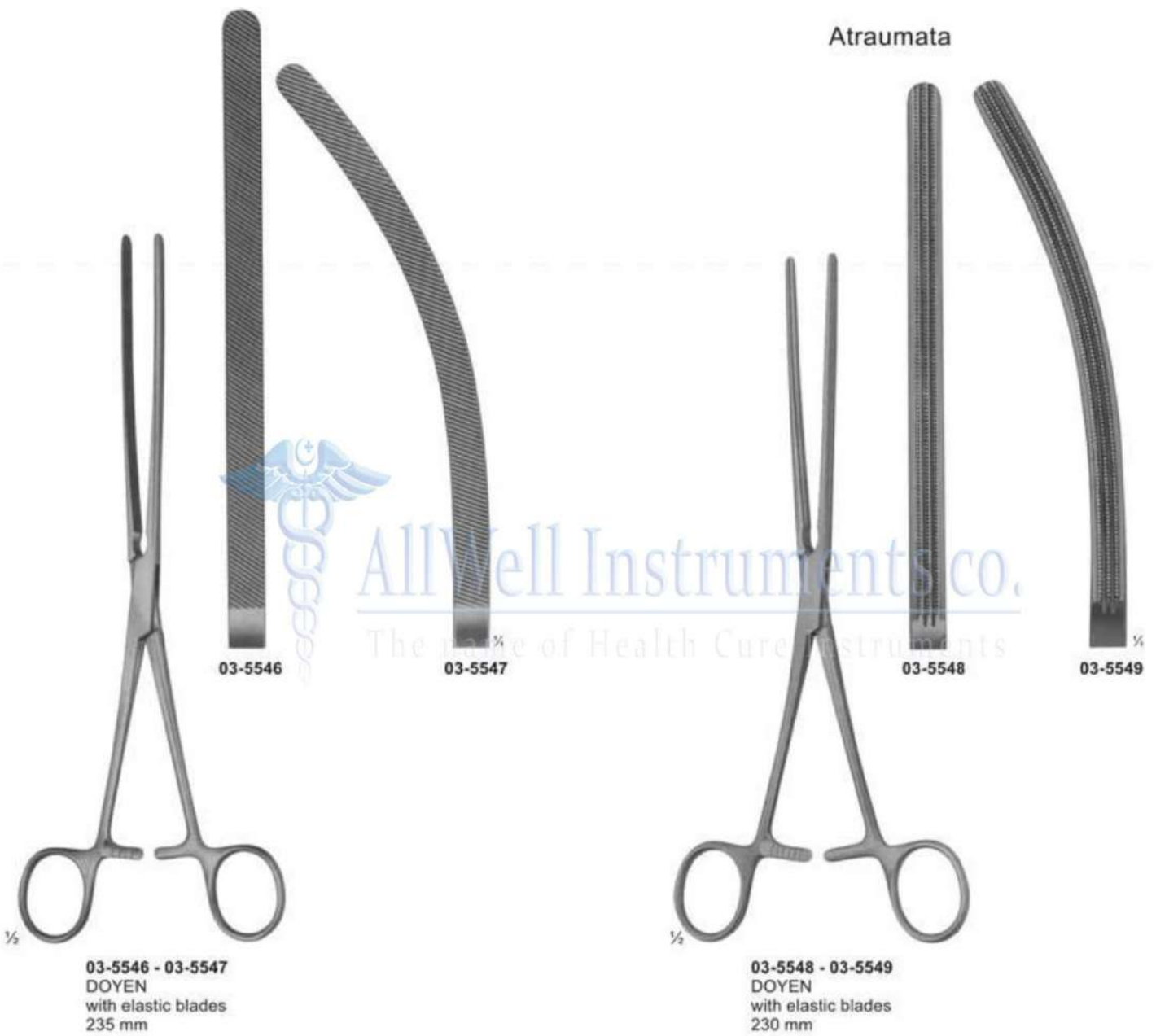

03-5546

03-5547

03-5548

03-5549

1/2

**03-5546 - 03-5547**  
 DOYEN  
 with elastic blades  
 235 mm

1/2

**03-5548 - 03-5549**  
 DOYEN  
 with elastic blades  
 230 mm



## Intestinal Clamps, Soft elastic

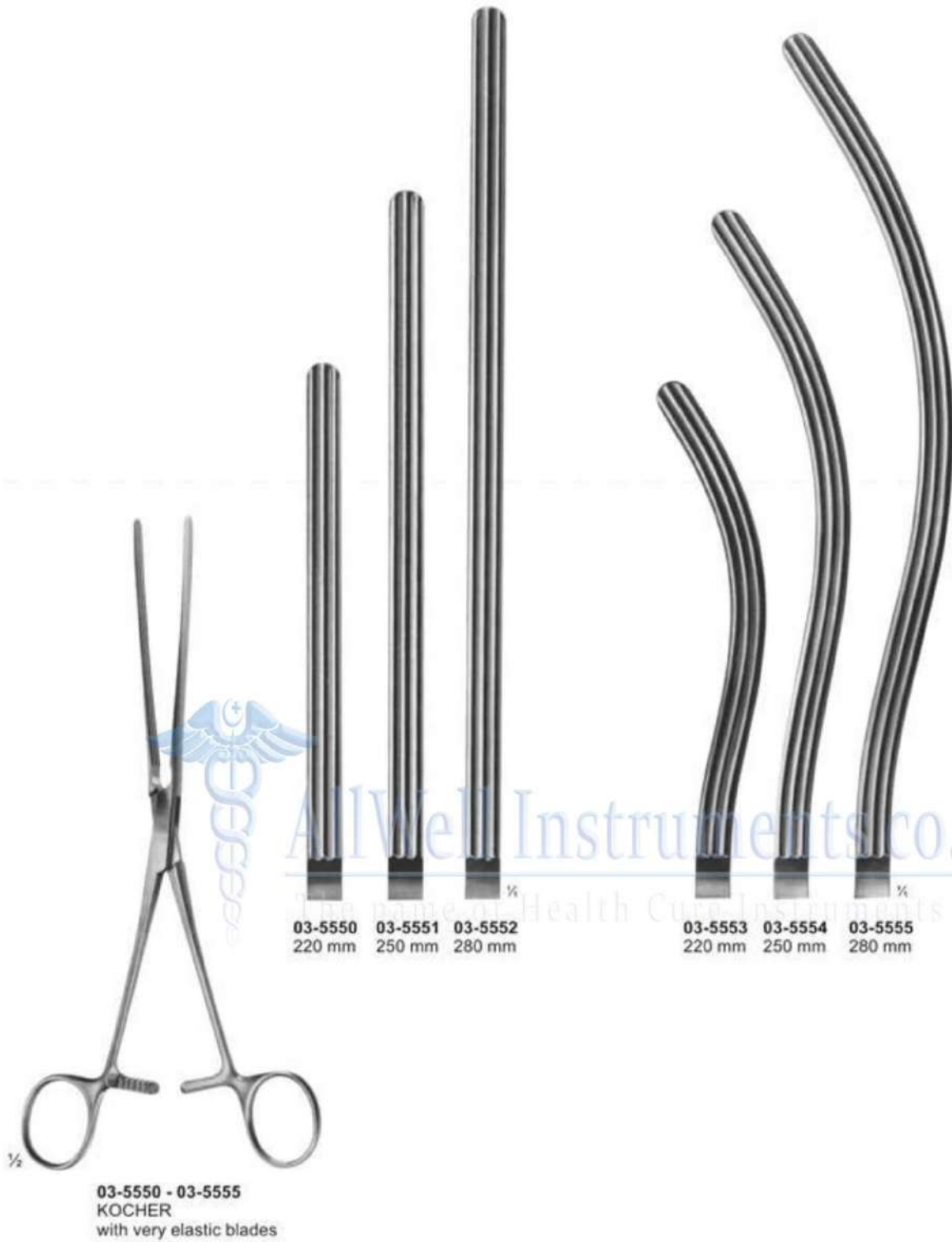

# Intestinal Clamps, Soft elastic

Atraumata



½

**03-5556 - 03-5561**  
**KOCHER**  
 with very elastic blades

**03-5556** 220 mm  
**03-5557** 250 mm  
**03-5558** 280 mm

**03-5559** 220 mm  
**03-5560** 250 mm  
**03-5561** 280 mm

## Intestinal Clamps





# Intestinal Clamps

## Atraumata



**03-5565 - 03-5566**  
 MAYO-ROBSON  
 hard elastic  
 250 mm

**03-5567 - 03-5568**  
 MAYO-ROBSON  
 250 mm

## Gastro-Intestinal Forceps, twin



**03-5569**  
LANE  
300 mm

**03-5570**  
LANE  
300 mm

## Stomach Clamps

Atraumata





## Intestinal and Pylorus Clamps



$\frac{1}{2}$   
**03-5574**  
 PAYR  
 Intestinal clamp  
 light pattern,  
 for children  
 180 mm

$\frac{1}{2}$   
**03-5575**  
 PAYR  
 200 mm

$\frac{1}{2}$   
**03-5576**  
 PAYR  
 275 mm

$\frac{1}{2}$   
**03-5577**  
 PAYR  
 Pylorus clamp  
 315 mm

# Anastomosis Forceps

## Atraumata



**03-5579**  
255 mm

**03-5580**  
265 mm

**03-5581**  
275 mm



**03-5578**  
**PARKER-KERR**  
anastomosis forceps  
for colon resection  
250 mm



**03-5579 - 03-5581**  
**DICK**  
pressure clamps

 **AllWell Instruments co.**  
The name of Health Care Instruments

## Sigmoid Anastomosis Forceps





# Atraumata Sigmoid Anastomosis Forceps

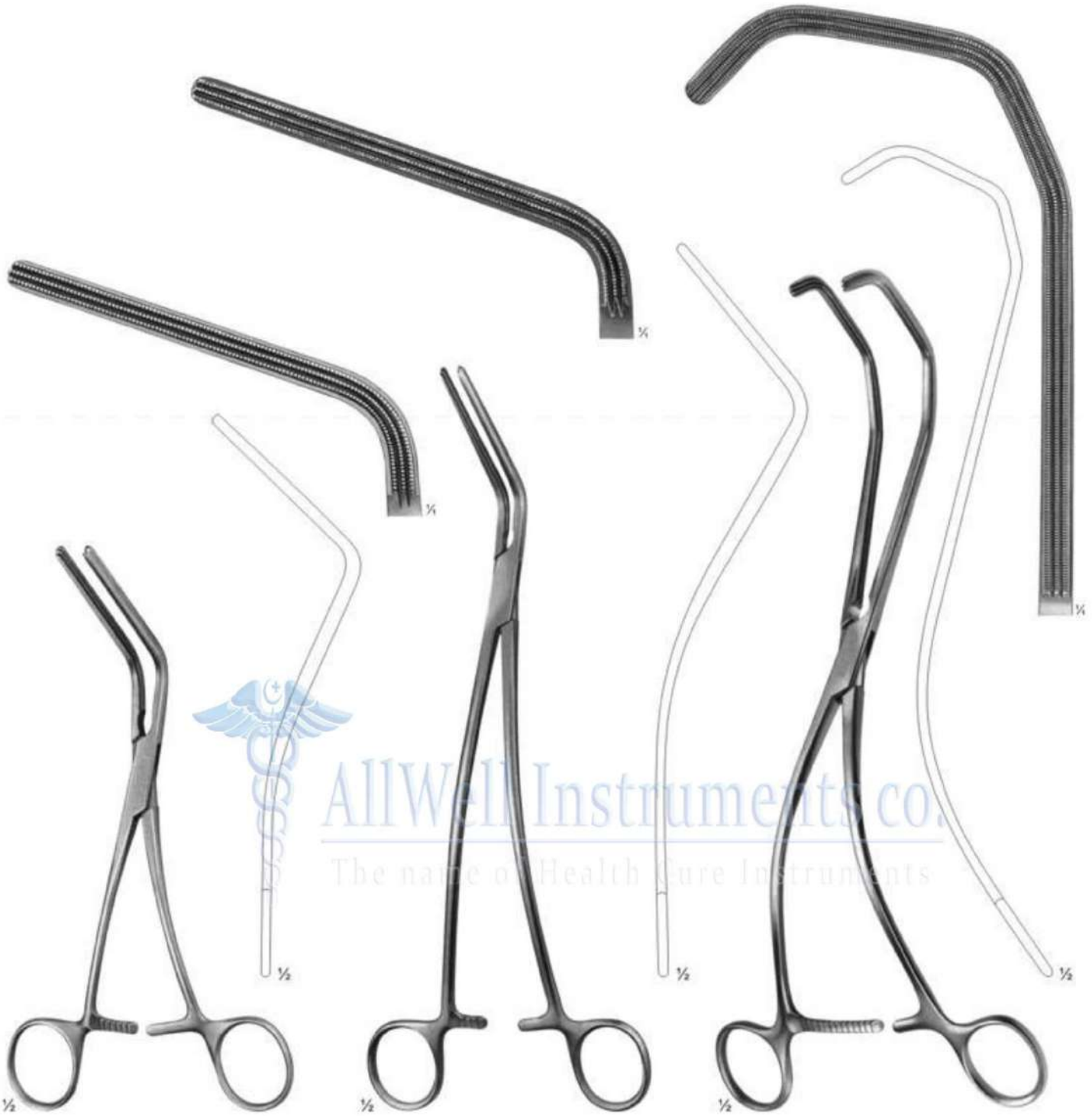

**03-5585**  
**MORRIS**  
175 mm

**03-5586**  
**DE BAKEY**  
(MORRIS modif.)  
240 mm

**03-5587**  
**KERSTING**  
270 mm

# Rectal Specula



**03-5588**  
**KILLIAN**  
 for children  
 145 mm



**03-5589**  
**SIMS**  
 160 mm



**03-5590**  
**SIMS**  
 160 mm

AllWell Instruments co.  
 The name of Health Care Instruments

# Rectal Specula



03-5591 - 03-5594



03-5591  
SIMS  
for children  
190 mm

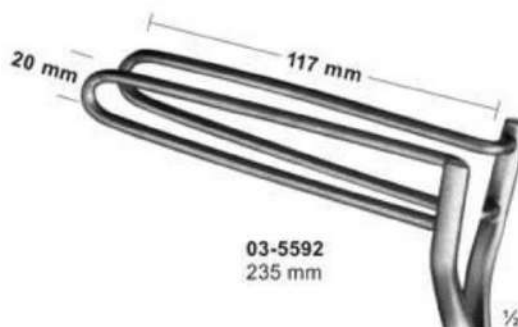

03-5592  
235 mm

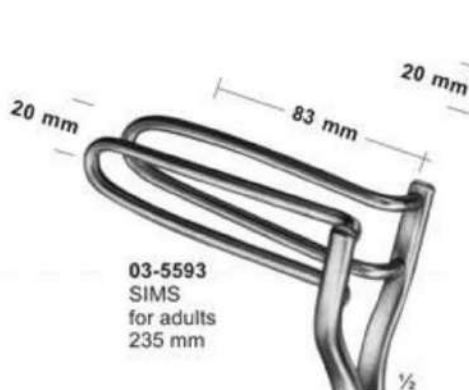

03-5593  
SIMS  
for adults  
235 mm



03-5594  
245 mm



03-5595  
PRATT  
205 mm



03-5596  
MATHIEU  
215 mm



## Anuscopy-Sphincteroscopes, Proctoscopes



**03-5597**  
IVES-FANSLER  
Anuscopy  
145 mm  
∅ 24mm



**03-5598**  
KELLY  
Sphincteroscope  
160 mm  
∅ 21mm

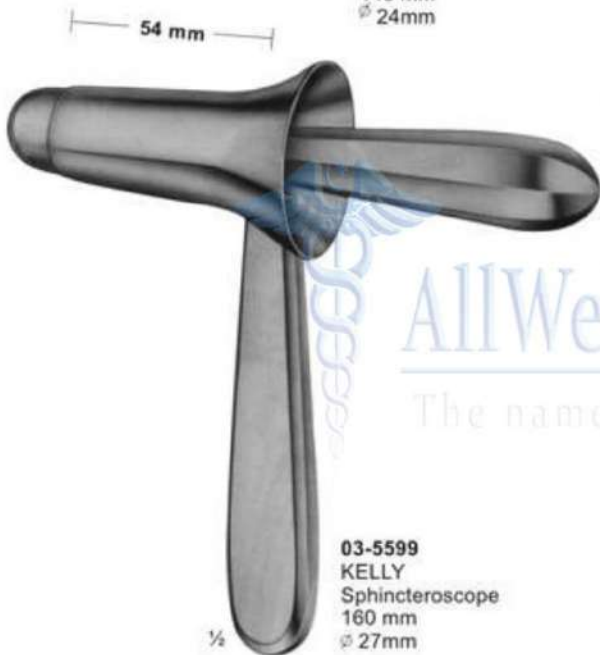

**03-5599**  
KELLY  
Sphincteroscope  
160 mm  
∅ 27mm



**03-5600**  
KELLY  
Proctoscope  
140 mm  
∅ 22mm

**AllWell Instruments co.**  
The name of Health Cure Instruments

## Biopsy forceps for rectum

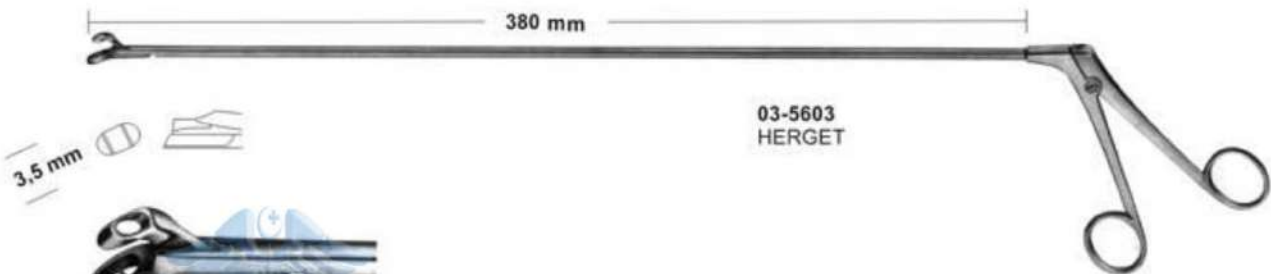
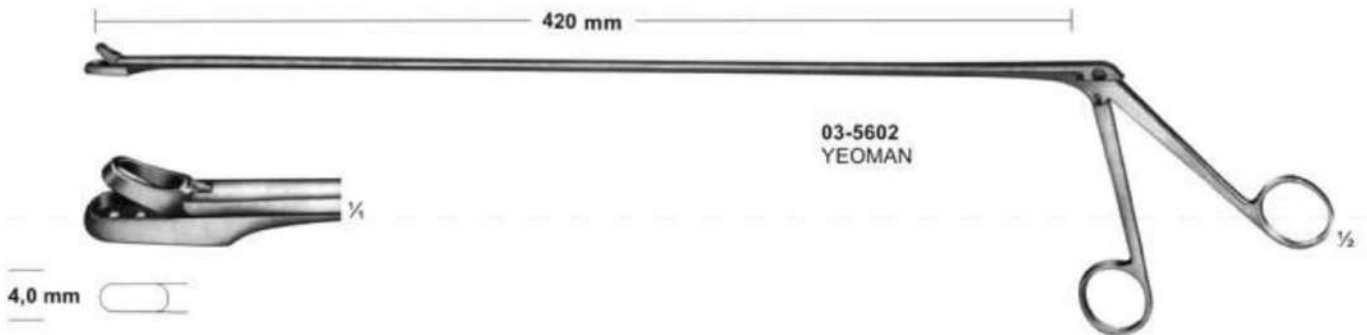
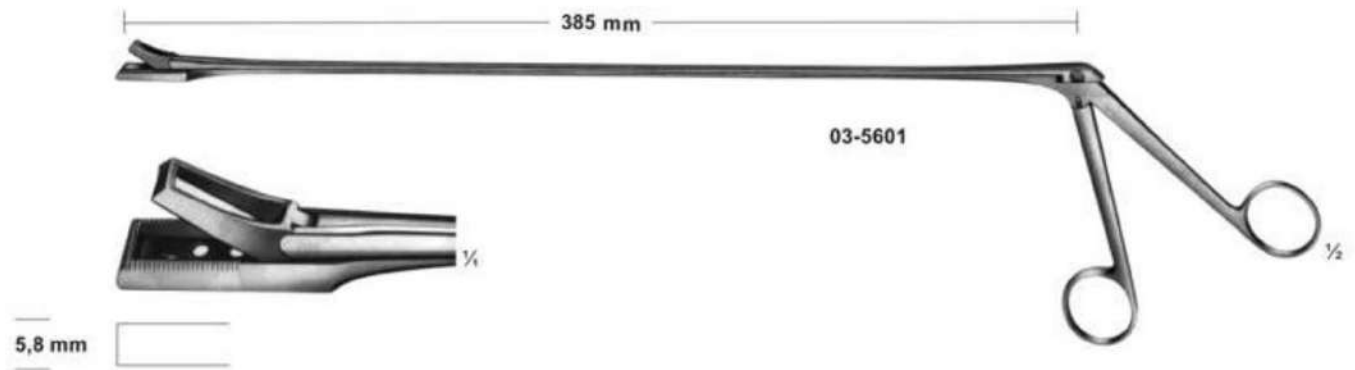

With Drawing Cut

AllWell Instruments co.

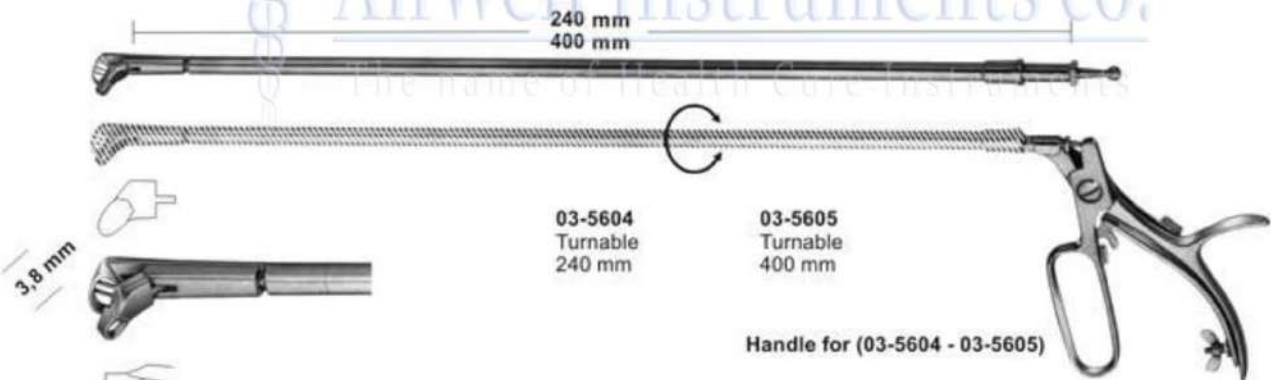

With Drawing Cut,  
Attachments only

## Biopsy Forceps & Swab Holders

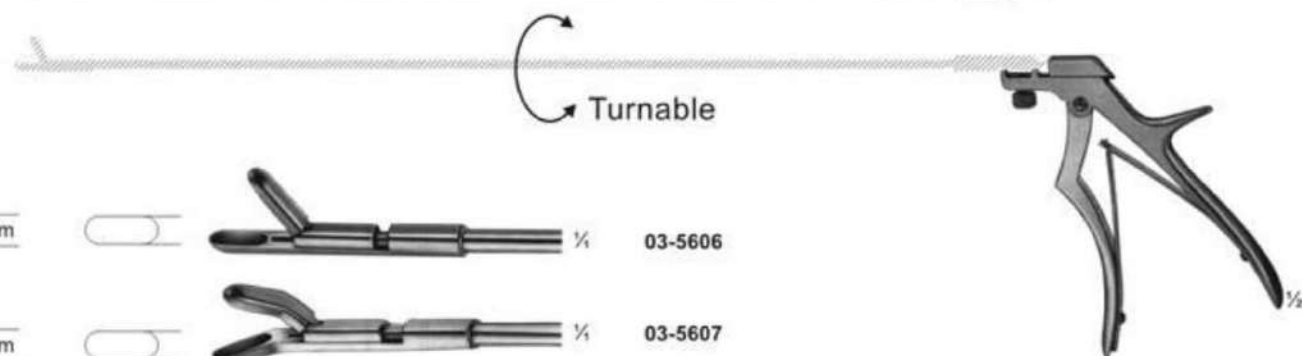
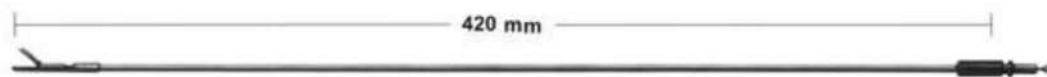

3,5 mm   1/4 **03-5606**

3,5 mm   1/4 **03-5607**

4,0 mm   1/4 **03-5608**

4,0 mm   1/4 **03-5609**

**Biopsy Forceps**

**03-5606 - 03-5609**  
Handle for

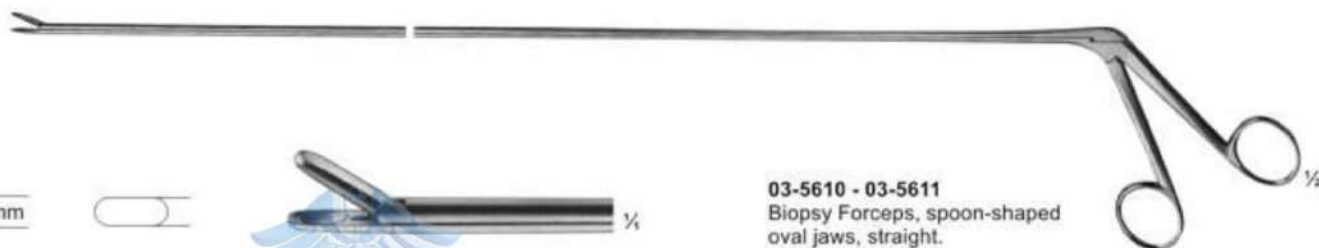

3,5 mm   1/4

**03-5610 - 03-5611**  
Biopsy Forceps, spoon-shaped  
oval jaws, straight.  
**03-5610** 350mm  
**03-5611** 500mm

**AllWell Instruments co.**  
The name of Health Cure Instruments

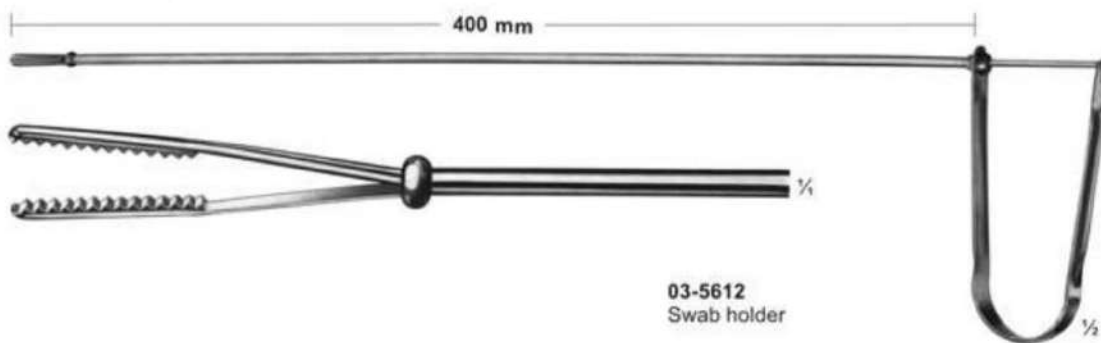

**03-5612**  
Swab holder



# Haemorrhoidal Forceps



# Haemorrhoidal Forceps

## Atraumata



## Pressure Clamp

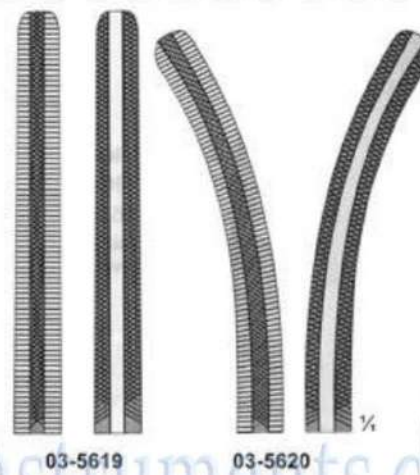

**03-5617**  
 250 mm  
**03-5618**  
 270 mm

**03-5619 - 03-5620**  
**FERGUSSON**  
 200 mm

**03-5621**  
**RUDD**  
 Haemorrhoidal ligator  
 with loading  
 attachment and 100  
 ligature rubber rings  
 315 mm

# Gall Duct Forceps



**03-5622**  
LOWER  
180 mm



**03-5623**  
LAHEY ( SWEET )  
190 mm



**03-5624**  
LAHEY  
220 mm



**03-5625**  
DESJARDINS  
Gall duct-and cystic forceps  
210 mm



**03-5626**  
NISSEN  
Gall duct-and cystic forceps  
215 mm

AllWell Instruments co.

The name of Health Care Instruments



# Gall Duct Forceps and Choledochus Forceps

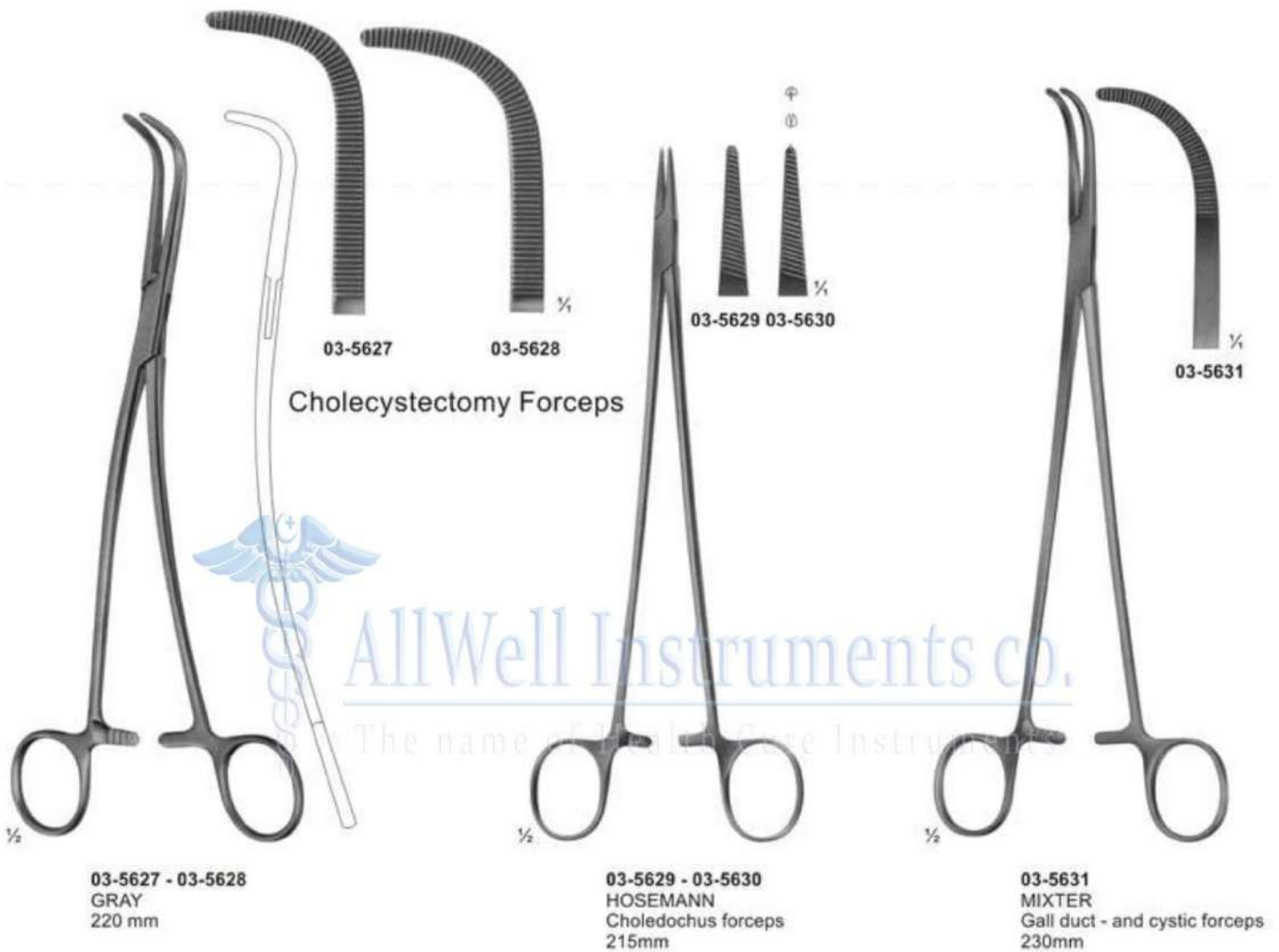

1/2  
**03-5627 - 03-5628**  
GRAY  
220 mm

1/2  
**03-5629 - 03-5630**  
HOSEMANN  
Choledochus forceps  
215mm

1/2  
**03-5631**  
MIXTER  
Gall duct - and cystic forceps  
230mm

## Gall Bladder Forceps and Gall Duct Scissors

Atraumata

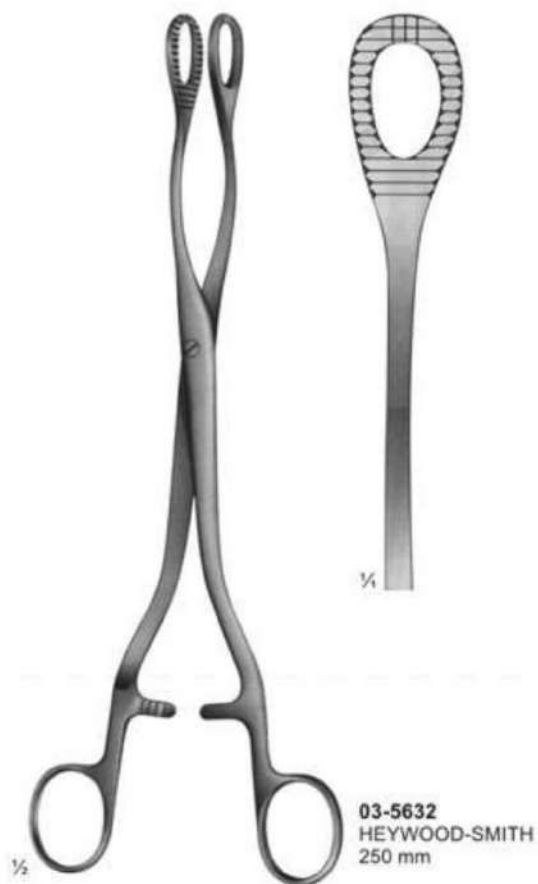

# Gall Duct Probes

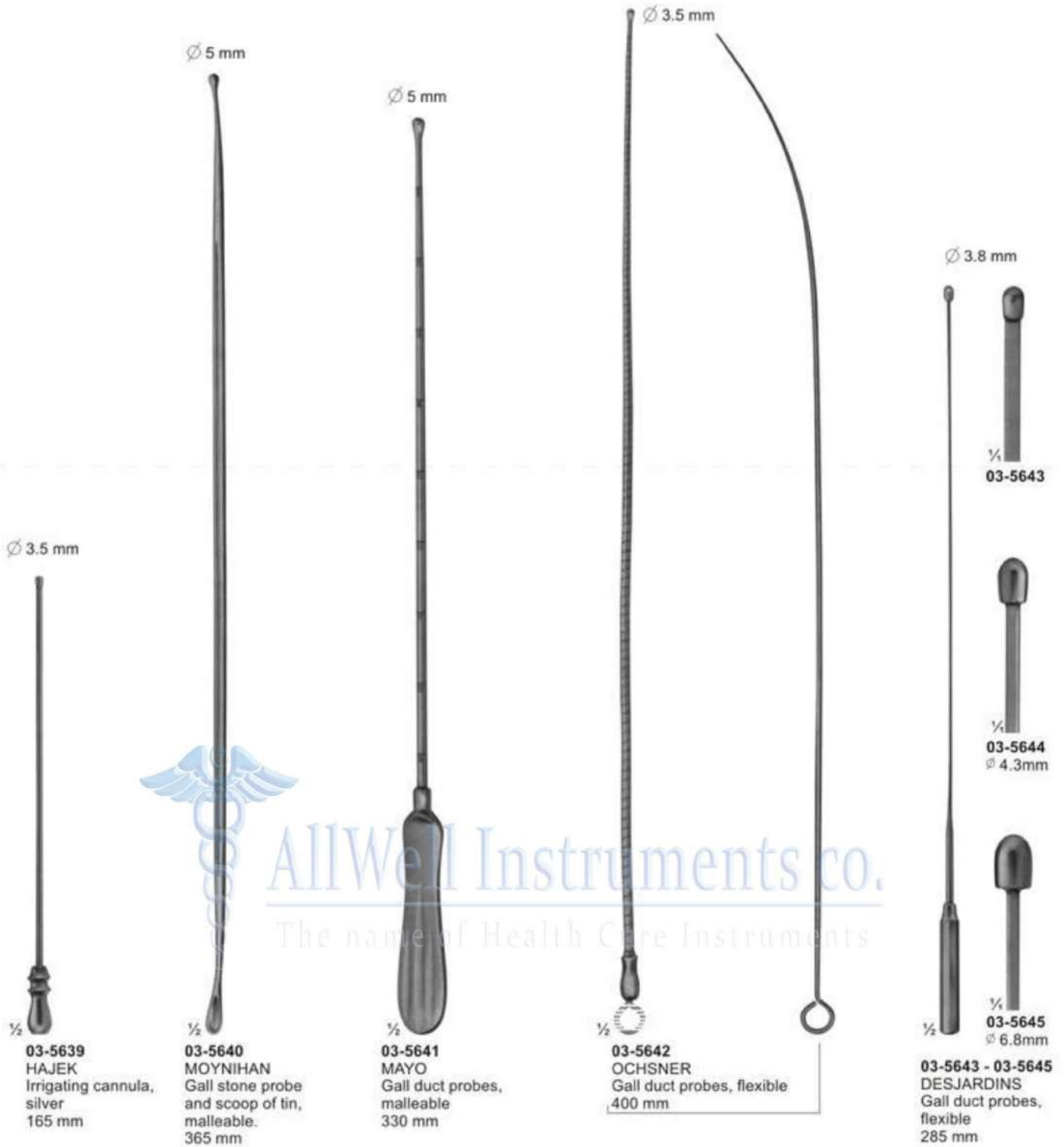



# Gall Duct Dilators & Gall Stone Scoops

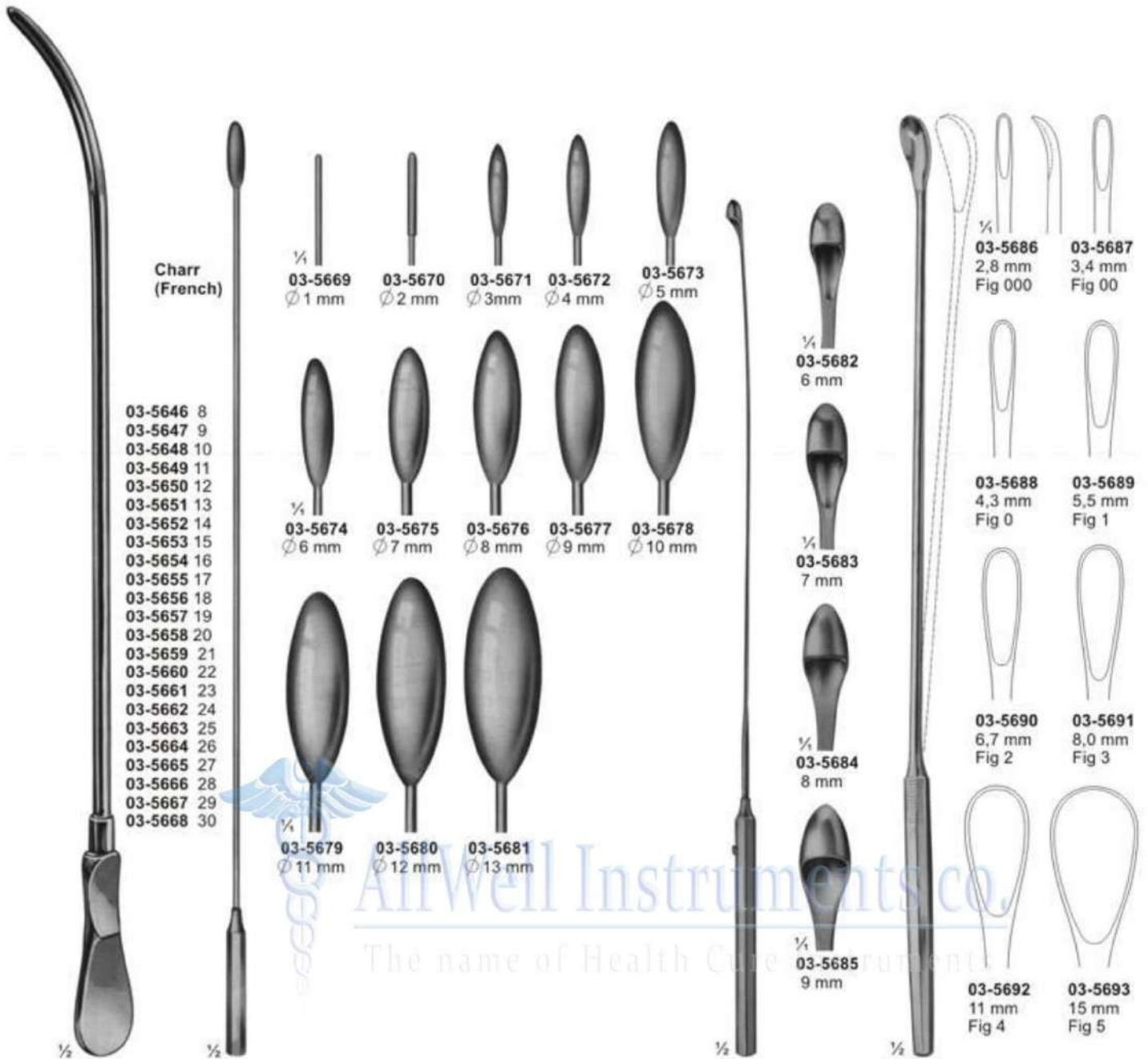

**Charr  
(French)**

- 03-5646 8
- 03-5647 9
- 03-5648 10
- 03-5649 11
- 03-5650 12
- 03-5651 13
- 03-5652 14
- 03-5653 15
- 03-5654 16
- 03-5655 17
- 03-5656 18
- 03-5657 19
- 03-5658 20
- 03-5659 21
- 03-5660 22
- 03-5661 23
- 03-5662 24
- 03-5663 25
- 03-5664 26
- 03-5665 27
- 03-5666 28
- 03-5667 29
- 03-5668 30

- 1/4 03-5669  $\varnothing$  1 mm
- 1/4 03-5670  $\varnothing$  2 mm
- 1/4 03-5671  $\varnothing$  3 mm
- 1/4 03-5672  $\varnothing$  4 mm
- 1/4 03-5673  $\varnothing$  5 mm
- 1/4 03-5674  $\varnothing$  6 mm
- 1/4 03-5675  $\varnothing$  7 mm
- 1/4 03-5676  $\varnothing$  8 mm
- 1/4 03-5677  $\varnothing$  9 mm
- 1/4 03-5678  $\varnothing$  10 mm
- 1/4 03-5679  $\varnothing$  11 mm
- 1/4 03-5680  $\varnothing$  12 mm
- 1/4 03-5681  $\varnothing$  13 mm

- 1/4 03-5682 6 mm
- 1/4 03-5683 7 mm
- 1/4 03-5684 8 mm
- 1/4 03-5685 9 mm

- 1/4 03-5686 2,8 mm Fig 000
- 1/4 03-5687 3,4 mm Fig 00
- 1/4 03-5688 4,3 mm Fig 0
- 1/4 03-5689 5,5 mm Fig 1
- 1/4 03-5690 6,7 mm Fig 2
- 1/4 03-5691 8,0 mm Fig 3
- 1/4 03-5692 11 mm Fig 4
- 1/4 03-5693 15 mm Fig 5

**03-5646 - 03-5668**  
**DITTEL**  
Metal bougies and dilating sounds, stiff 345 mm

**03-5669 - 03-5681**  
**BAKES**  
Common bile duct dilators, malleable  
**03-5669-03-5673** 315mm  
**03-5674-03-5681** 320mm  
Set of 9 pieces (**03-5671-03-5679**) in canvas roll

**03-5682 - 03-5685**  
**DESJARDINS**  
Probes and catch with flexible shaft 300 mm

**03-5686 - 03-5693**  
**LUER-KOERTE**  
modif with malleable shaft 310 mm

# Gall Stone Forceps

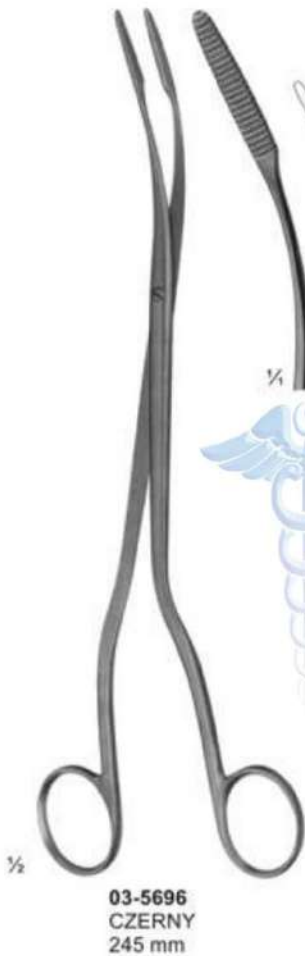

**AllWell Instruments co.**  
The name of Health Care Instruments

# Kidney Clamps

Atraumata



$\frac{1}{4}$   
**03-5703**  
 240 mm

$\frac{1}{4}$

$\frac{1}{4}$   
**03-5706** **03-5707**

**03-5708**

**03-5704**  
 230 mm

$\frac{1}{2}$   
**03-5703 - 03-5704**  
 GUYON

$\frac{1}{2}$   
**03-5705**  
 GUYON  
 230 mm

$\frac{1}{2}$   
**03-5706 - 03-5708**  
 PEAN  
**03-5706 - 195 mm**  
**03-5707 - 220 mm**  
**03-5708 - 230 mm**



## Kidney and Pedicle Clamps

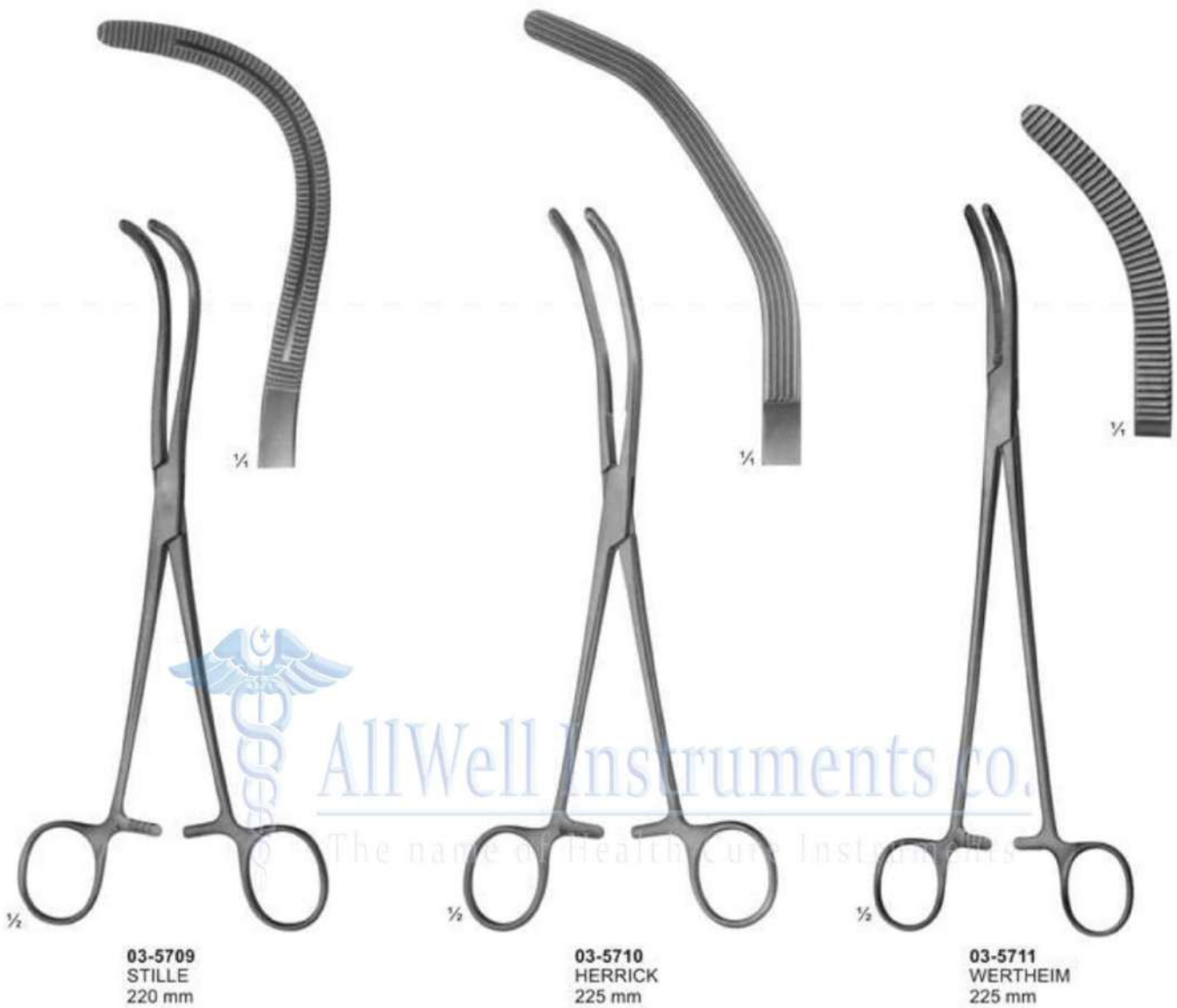

## Kidney Elevating Forceps



03-5712  
COLLIN  
285 mm



03-5713  
DARTIGUES  
255 mm

 AllWell Instruments co.  
The name of Health Care Instruments

# Kidney Stone Forceps



03-5714



03-5715



03-5716



1/4  
03-5717



03-5718



1/4  
03-5719



1/2

03-5714 - 03-5717  
RANDALL  
225 mm



1/2

03-5718 - 03-5719  
RANDALL  
190 mm

AllWell Instruments co.  
The name of Health Cure Instruments



# Bladder Retractors

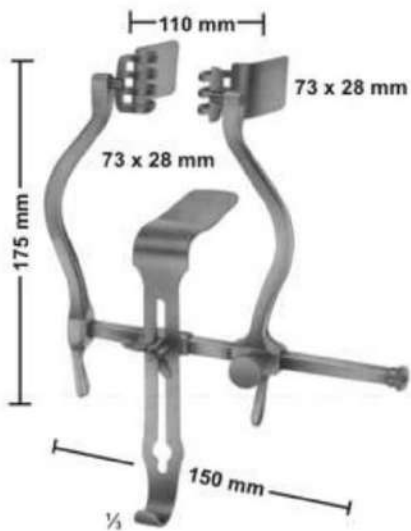

**03-5720**  
**JUDD-MASSON**  
Bladder-and suprapubic  
retractor

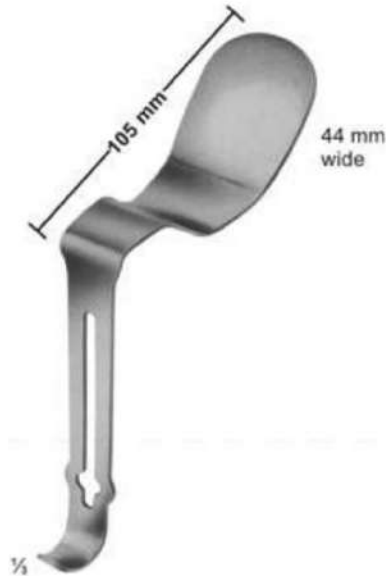

**03-5721**  
**MILLIN**  
Center blade for ( 05-6993)  
retro pubic prostatectomy



**03-5722**  
**MILLIN**  
Bladder retractor  
**03-5722** Spreader only  
**03-5723** Blades 57x25mm  
**03-5724** Blades 82x25mm  
**03-5725** Center blade 105x45mm



**03-5726**  
**LEGUEU**  
Bladder retractor  
Center blade  
80 x 31 mm



**03-5727**  
**LEGUEU**  
Bladder spatula  
260 mm



**03-5728**  
**KOCHER**  
Bladder spatula  
235 mm

# Genito-Urinary Instruments



**03-5729**  
**MATHIEU**  
Foreign body forceps  
Length of shaft  
190 mm



**03-5730**  
**MILLIN**  
Lobe grasping  
forceps  
235 mm

Atraumata

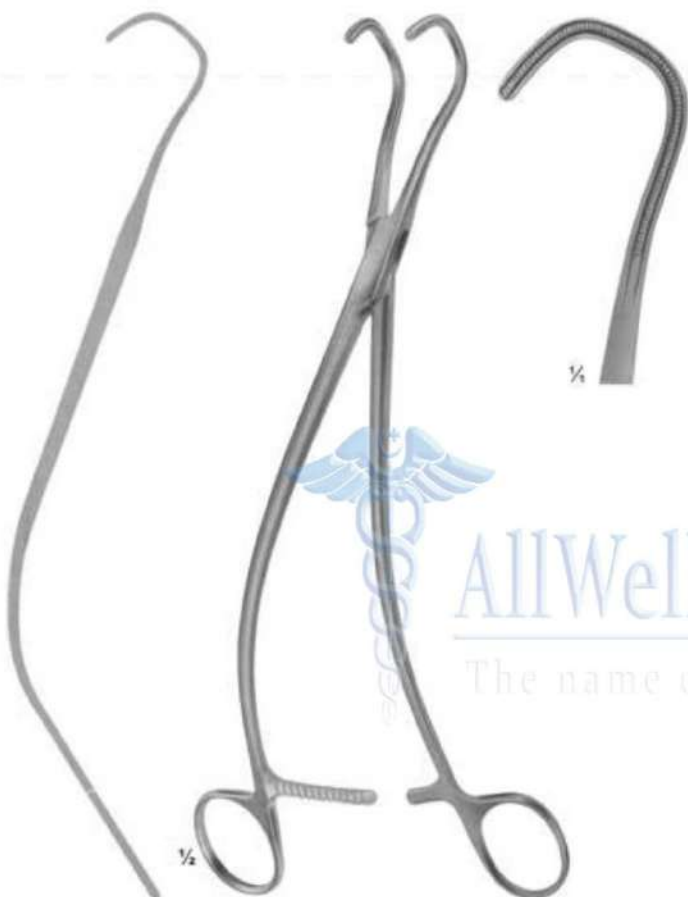

**03-5731**  
**Ureter forceps**  
240 mm

Atraumata



**03-5732**  
**MILLIN**  
Lobe grasping  
forceps  
245 mm



**03-5733**  
**MILLIN**  
Bladder neck spreader  
285 mm

AllWell Instruments Co.  
The name of Health Care Instruments

# Genito-Urinary Instruments



**03-5734**  
GUYON  
Catheter guide  
(introducer)  
365 mm



**Charr.  
(French)**

- 03-5735 6
- 03-5736 7
- 03-5737 8
- 03-5738 9
- 03-5739 10
- 03-5740 11
- 03-5741 12
- 03-5742 13
- 03-5743 14
- 03-5744 15
- 03-5745 16
- 03-5746 18
- 03-5747 20



**03-5735 - 03-5747**  
Female catheters,  
metal  
160 mm

**Charr.  
(French)**

- 03-5748 8
- 03-5749 9
- 03-5750 10
- 03-5751 11
- 03-5752 12
- 03-5753 13
- 03-5754 14
- 03-5755 15
- 03-5756 16
- 03-5757 17
- 03-5758 18
- 03-5759 19
- 03-5760 20
- 03-5761 21
- 03-5762 22
- 03-5763 23
- 03-5764 24
- 03-5765 25
- 03-5766 26
- 03-5767 27
- 03-5768 28
- 03-5769 29
- 03-5770 30

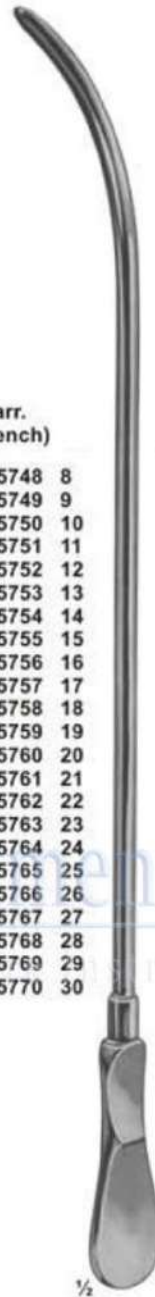

**03-5748 - 03-5770**  
DITTEL  
Urethral bougies  
and dilating sounds  
345 mm

- 03-5771 Ben. 24/Charr. 12
- 03-5772 Ben. 25
- 03-5773 Ben. 26/Charr. 13
- 03-5774 Ben. 27
- 03-5775 Ben. 28/Charr. 14
- 03-5776 Ben. 29
- 03-5777 Ben. 30/Charr. 15
- 03-5778 Ben. 31
- 03-5779 Ben. 32/Charr. 16
- 03-5780 Ben. 33
- 03-5781 Ben. 34/Charr. 17
- 03-5782 Ben. 35
- 03-5783 Ben. 36/Charr. 18
- 03-5784 Ben. 37
- 03-5785 Ben. 38/Charr. 19
- 03-5786 Ben. 39
- 03-5787 Ben. 40/Charr. 20
- 03-5788 Ben. 41
- 03-5789 Ben. 42/Charr. 21
- 03-5790 Ben. 43
- 03-5791 Ben. 44/Charr. 22
- 03-5792 Ben. 45
- 03-5793 Ben. 46/Charr. 23
- 03-5794 Ben. 47
- 03-5795 Ben. 48/Charr. 24
- 03-5796 Ben. 49
- 03-5797 Ben. 50/Charr. 25
- 03-5798 Ben. 51
- 03-5799 Ben. 52/Charr. 26
- 03-5800 Ben. 53
- 03-5801 Ben. 54/Charr. 27
- 03-5802 Ben. 55
- 03-5803 Ben. 56/Charr. 28
- 03-5804 Ben. 57
- 03-5805 Ben. 58/Charr. 29
- 03-5806 Ben. 59
- 03-5807 Ben. 60/Charr. 30

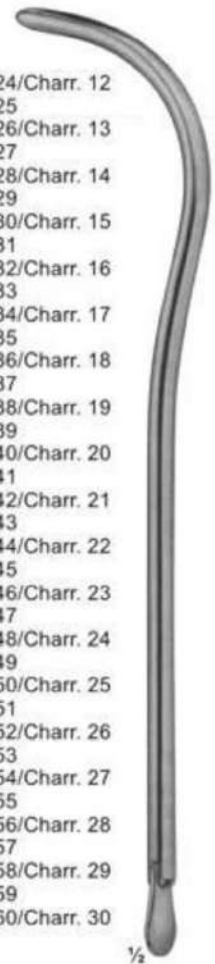

**03-5771 - 03-5807**  
GUYON  
Urethral bougies  
and dilating sounds,  
without filiform guides,  
with thread in tip  
255 mm



## Genito-Urinary Instruments & Circumcision Clamps



**03-5808**  
**GUYON**  
 Set of urethral bougies and dilating sounds, in metal case, with lift out rack and bottom rack, containing 21 urethral and dilating sounds, metal.



**03-5809 - 03-5811**  
**WINKELMANN**  
**03-5809** ∅ 12mm  
**03-5810** ∅ 16mm  
**03-5811** ∅ 20mm

### Circumcision Clamps

Assisted by two haemostats or ligatures the foreskin is pushed over the bellshaped protection - rod and the glans is placed into it. By now, the wing - nut is tightened as close as possible, so the foreskin in annular compressed. The foreskin is cut of with a scalpel, right next to the compression ring. The circumcision clamp remains a few minutes to avoid bleeding. In case that any large vein, specially the frenular artery, is cut through, a ligature must be set. The advantage of the method described is the cosmeticy favourable scar which is left after rejection of the small necrotized portion.

# Trocars

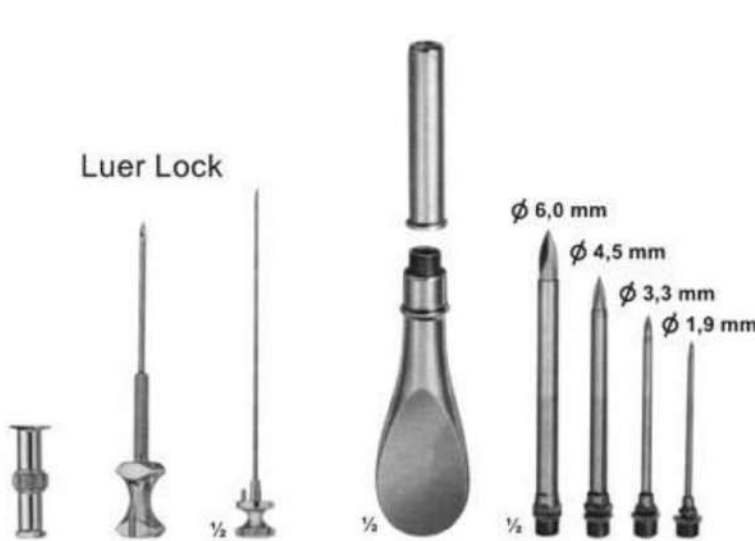

Luer Lock

**03-5812**  
**KLIMA ROSEGGER**  
 35 X 1,8 mm  
 Sternal puncture needle

**03-5813**  
 Universal trocar  
 with 4 tips

$\phi$  6,0 mm  
 $\phi$  4,5 mm  
 $\phi$  3,3 mm  
 $\phi$  1,9 mm

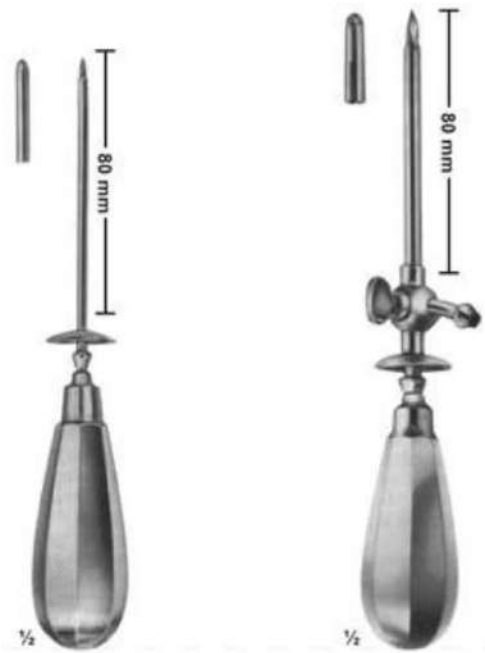

**03-5814 - 03-5818**  
**NELSON**

	Inside diam	Outside diam
<b>03-5814</b>	2,2 mm	3,0 mm
<b>03-5815</b>	3,0 mm	4,0 mm
<b>03-5816</b>	4,0 mm	5,0 mm
<b>03-5817</b>	5,0 mm	6,0 mm
<b>03-5818</b>	5,5 mm	6,5 mm

for hydrocele and abdominal puncture

**03-5819 - 03-5822**

	Inside diam	Outside diam
<b>03-5819</b>	2,2 mm	3,0 mm
<b>03-5820</b>	3,0 mm	4,0 mm
<b>03-5821</b>	4,0 mm	5,0 mm
<b>03-5822</b>	5,0 mm	6,0 mm

for abdominal puncture, with stop-cock and lateral drain



**03-5823** 100 mm  
**03-5824** 110 mm

**03-5823 - 03-5824**  
**BUELAU**

	Inside diam	Outside diam
<b>03-5823</b>	6,5 mm	8,0 mm
<b>03-5824</b>	9,0 mm	10,0 mm

Empyema trocar



**03-5825 - 03-5828**  
**OCHSNER**  
 Inside diam. Outside diam

<b>03-5825</b>	3,0 mm	4,0 mm
<b>03-5826</b>	3,6 mm	4,6 mm
<b>03-5827</b>	4,3 mm	5,3 mm
<b>03-5828</b>	5,0 mm	6,0 mm

Gall bladder trocars



**03-5829**  
**PIERCE**  
 Antrum trocar  
 $\phi$  4,0 mm



**03-5830**  
**COAKLEY**  
 Antrum trocar  
 $\phi$  3,0 mm



## Section - 04

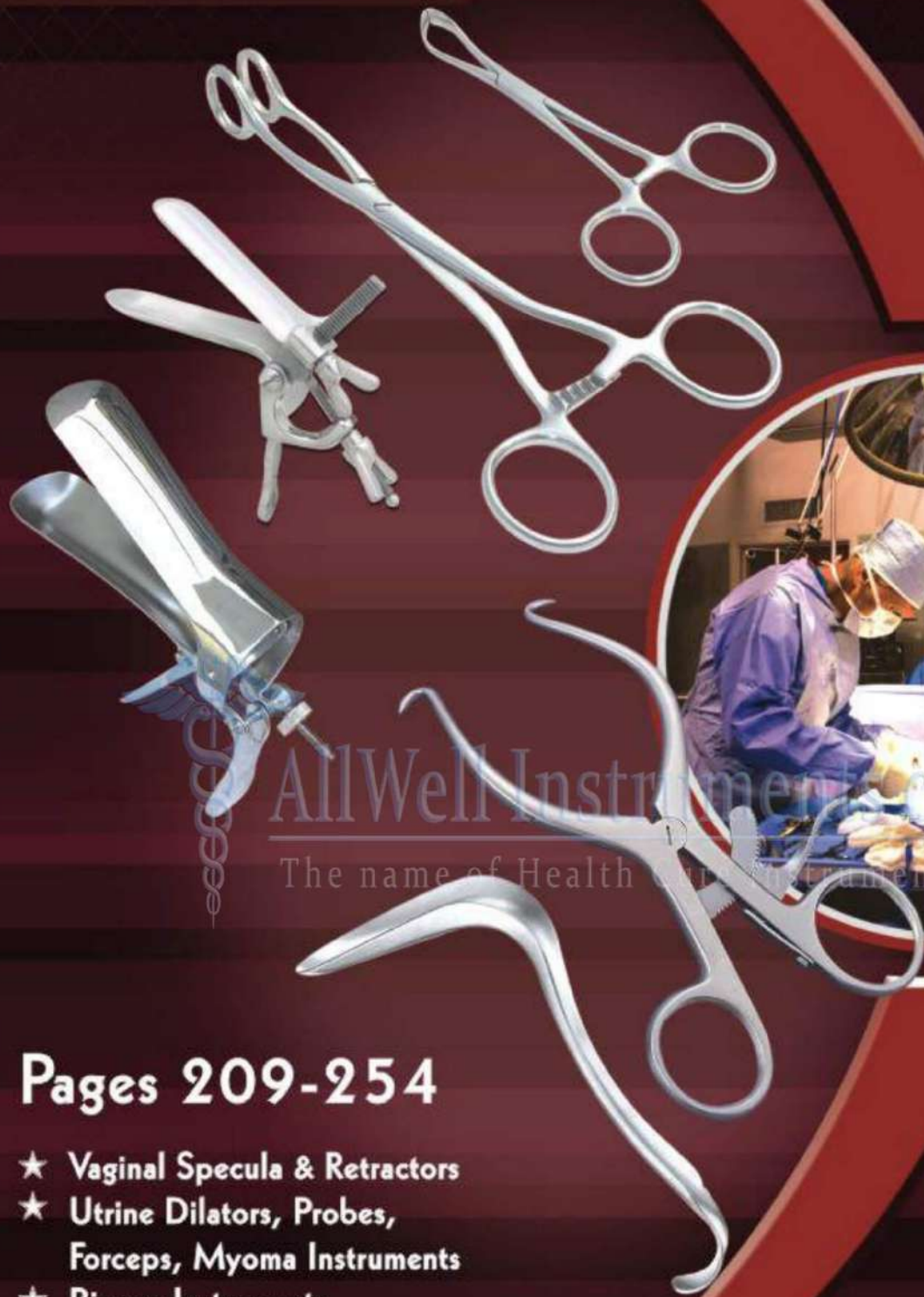

AllWell Instruments  
The name of Health Care Instruments

**Pages 209-254**

- ★ Vaginal Specula & Retractors
- ★ Utrine Dilators, Probes, Forceps, Myoma Instruments
- ★ Biopsy Instruments, Utrine Curettes / Scoops
- ★ Obstetrics Instruments



## Vaginal specula

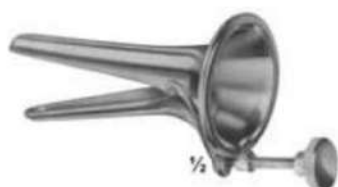

**04-6001**  
COLLIN  
for children  
53 x 10 mm

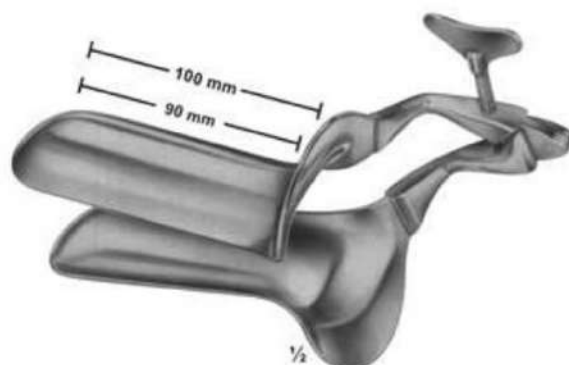

**04-6002 - 04-6005**  
COLLIN  

<b>04-6002</b>	100/90mm	28 mm
<b>04-6003</b>	100/90mm	32 mm
<b>04-6004</b>	105/95mm	35 mm
<b>04-6005</b>	115/105mm	40 mm

 Total length/working length width



**04-6006**  
COLLIN  
for virgins  
95/85 x 18 mm



**04-6007**  
CUSCO  
for virgins  
75 x 17 mm



**04-6008**  
CUSCO  
for virgins  
75 x 17 mm



**04-6009 - 04-6011**  
CUSCO  
Swiss patterns features:  
long and narrow  
**04-6009** 92x23-25 mm  
**04-6010** 100x25-27 mm  
**04-6011** 110x27-30 mm

# Vaginal Specula



**04-6012 - 04-6015**  
CUSCO  
STANDARD  
**04-6012** 80X24 mm  
**04-6013** 80X32 mm  
**04-6014** 90X36 mm  
**04-6015** 110X37 mm



**04-6016 - 04-6019**  
CUSCO  
**04-6016** 80X24 mm  
**04-6017** 80X32 mm  
**04-6018** 90X36 mm  
**04-6019** 110X37 mm



Flat (duck beak)

**04-6020 - 04-6022**  
CUSCO  
**04-6020** 80X32 mm  
**04-6021** 90X37 mm  
**04-6022** 115X37 mm



**04-6023 - 04-6024**  
SEYFFERT  
**04-6023** 100X17 mm  
**04-6024** 110X33 mm  
230 mm



With double ratchet, closing and opening of ratchet by pressure of thumb

**04-6025**  
SEMM  
for children and virgins  
180 mm  
90X14-18mm

## Vaginal Specula, Sets, Upper & Lower Blades



**04-6026 - 04-6028**  
GRAVE  
04-6026 75X20 mm  
04-6027 95X30 mm  
04-6028 105X33 mm

1/2



**04-6029 - 04-6030**  
PEDERSON  
04-6029 100X22 mm  
04-6030 120X25 mm

1/2



**04-6031 - 04-6032**  
BRIESKY  
04-6031 72X25 mm / 77X30 mm 140mm  
04-6032 75X30 mm / 92X38 mm 170mm

1/2



**04-6033 - 04-6035**  
SIMS  
04-6033 70X26 mm / 75 X30 mm  
125 mm  
04-6034 75X30 mm / 80X35 mm  
150 mm  
04-6035 80X36 mm / 90X40mm  
175mm

1/2



**04-6036 - 04-6038**  
SEIDL  
04-6036 80X8 mm  
04-6037 80X10 mm  
04-6038 90X14 mm  
For children and infants  
170 mm

1/2



**04-6039**  
KRISTELLER  
70X15 mm, ( 170 mm )  
For children

1/2



**04-6040 - 04-6042**  
KRISTELLER  
04-6040 70X27 mm  
04-6041 75X30 mm  
04-6042 90X36 mm  
175 mm

1/2



## Vaginal Specula-Sets, upper and lower blades



04-6048 75X10 mm  
175 mm

04-6052 70X15 mm  
175 mm

04-6049 75X23 mm  
180 mm

04-6053 70X27 mm  
180 mm

04-6050 80X25 mm  
180 mm

04-6054 75X30 mm  
180 mm

04-6051 100X32 mm  
185 mm

04-6055 90X36 mm  
185 mm

1/2  
04-6043 - 04-6047  
KRISTELLER  
04-6043 110X18 mm  
04-6044 110X20 mm  
04-6045 110X27 mm  
04-6046 110X30 mm  
04-6047 110X36 mm  
220 mm

1/2  
04-6048 - 04-6051  
KRISTELLER  
Upper blades

1/2  
04-6052 - 04-6055  
KRISTELLER  
Lower blades

## Vaginal Specula-upper and lower blades



# Vaginal Specula



04-6066  
80 X 28 mm



04-6069  
76 X 38 mm



04-6067  
85 X 35 mm



04-6070  
89 X 38 mm



04-6068  
85 X 40 mm



04-6071  
102 X 38 mm

**AllWell Instruments co.**  
 The name of Health Cure Instruments

Slightly Concave

Slightly Concave



½

04-6066 - 04-6068  
KRISTELLER  
205 mm



½

04-6069 - 04-6071  
JACKSON  
175 mm



# Vaginal Specula-for children & virgins Vario Retractor

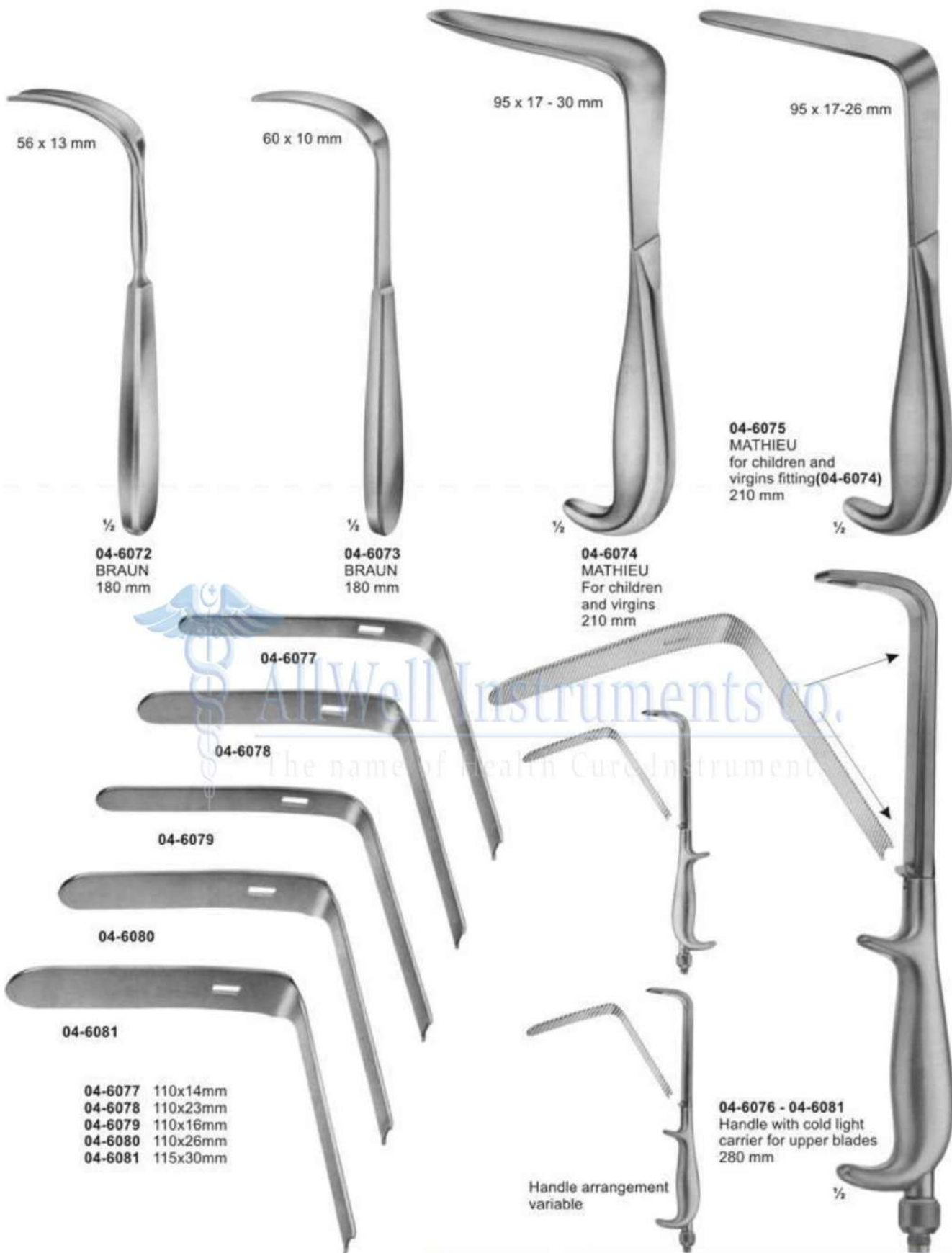

56 x 13 mm

60 x 10 mm

95 x 17 - 30 mm

95 x 17-26 mm

1/2  
**04-6072**  
BRAUN  
180 mm

1/2  
**04-6073**  
BRAUN  
180 mm

1/2  
**04-6074**  
MATHIEU  
For children  
and virgins  
210 mm

**04-6075**  
MATHIEU  
for children and  
virgins fitting(04-6074)  
210 mm

**04-6077**

**04-6078**

**04-6079**

**04-6080**

**04-6081**

**04-6077** 110x14mm  
**04-6078** 110x23mm  
**04-6079** 110x16mm  
**04-6080** 110x26mm  
**04-6081** 115x30mm

**04-6076 - 04-6081**  
Handle with cold light  
carrier for upper blades  
280 mm

Handle arrangement  
variable

## Vaginal Specula-for children and virgins

**04-6082**  
60 X 45 mm

**04-6083**  
90 X 45 mm

**04-6084**  
112 X 45 mm

**04-6082 - 04-6084**  
DOYEN  
235 mm

Length of blades	Width of blades			
	35 mm	45 mm	60 mm	
60 mm	<b>04-6085</b>	<b>04-6088</b>	<b>04-6091</b>	<b>04-6085 - 04-6094</b> DOYEN 240mm
90 mm	<b>04-6086</b>	<b>04-6089</b>	<b>04-6092</b>	
120 mm	<b>04-6087</b>	<b>04-6090</b>	<b>04-6093</b>	
160 mm		<b>04-6090A</b>	<b>04-6094</b>	

## Vaginal Specula / Retractors



**04-6095 - 04-6099**  
BREISKY  
WIENER MODELL/  
VIENNA PATTERN  
**04-6095** 100 X 20 mm  
**04-6096** 100 X 25 mm  
**04-6097** 100 X 30 mm  
**04-6098** 100 X 35 mm  
**04-6099** 100 X 40 mm  
300 mm

**04-6100 - 04-6104**  
BREISKY  
WIENER MODELL/  
VIENNA PATTERN  
**04-6100** 130 X 20 mm  
**04-6101** 130 X 25 mm  
**04-6102** 130 X 30 mm  
**04-6103** 130 X 35 mm  
**04-6104** 130 X 40 mm  
320 mm

**04-6107**  
removable strainer only

**04-6105 - 04-6106**  
WEISSBARTH  
**04-6105** 80 X 28 mm  
**04-6106** 85 X 42 mm  
210 mm

**04-6108**  
DOYEN  
lateral speculum  
80 x 30 mm  
250 mm



## Vaginal & Wound Retractor / Vaginal Specula



**04-6110**  
115 X 26 mm  
275 mm

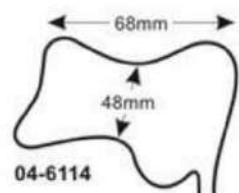

**04-6114**

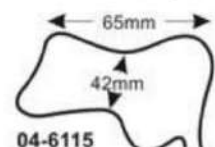

**04-6115**

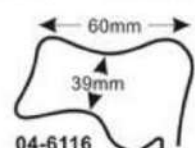

**04-6116**

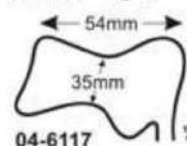

**04-6117**

**04-6109 - 04-6110**  
SIMON  
115 X 22 mm  
275 mm



**04-6111**  
AUVARD  
65 X 38 mm - 28 mm  
1,530 kg = 3 lbs  
with fixed weight  
230 mm

**04-6112 - 04-6113**  
AUVARD  
**04-6112** 75 X 42-40 mm  
**04-6113** 105 X 43-40 mm  
1,470 kg = 3 lbs  
with detachable weight  
230 mm



**04-6114 - 04-6117**  
MARTIN  
with hook shaped  
handle for hanging  
in weights  
270 mm

# Vaginal Speculas

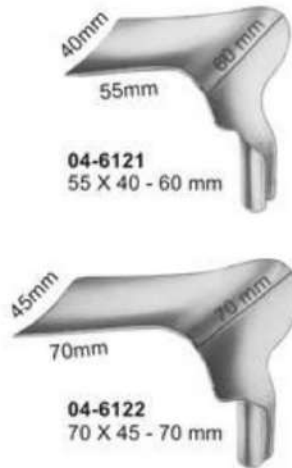

The mentioned blades (04-6118 - 04-6122 and 04-6125 - 04-6132) can be exchanged. They fit handle (04-6123), as well as handles (04-6133 and 04-6134).

**04-6118 - 04-6124**  
**SCHERBACK**  
Set consisting of:  
handle **04-6123**  
weight **04-6124**  
4 blades **04-6118 - 04-6121**



**04-6133**  
**BOZEMANN**  
Set consisting of:  
2 handle (04-6133 - 04-6134)  
8 blades (04-6125 - 04-6132)

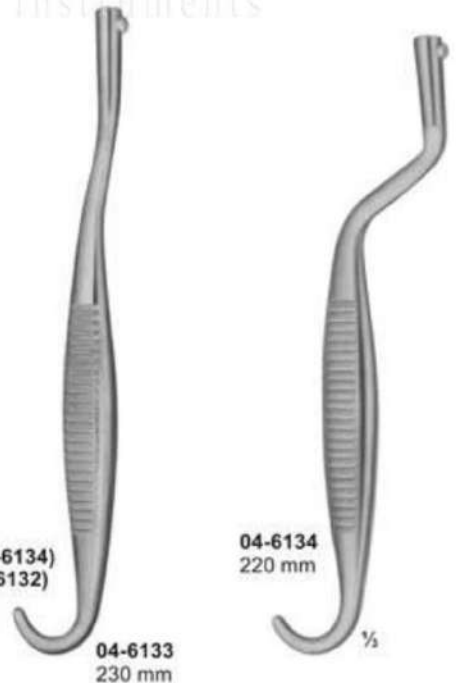

**AllWell Instruments co.**  
The name of Health Cure Instruments

# Vaginal Retractors



½  
**04-6135**  
JOLL (FRIEDMAN)  
155 mm



½  
**04-6136**  
RICHTER  
170 mm



AllWell Instruments co.

The name of Health Cure Instruments



½  
**04-6137**  
GELPI  
135 mm



½  
**04-6138**  
GELPI  
175 mm



## Uterine Dilators



1/2

04-6139	1	mm	04-6161	23	mm
04-6140	2	mm	04-6162	24	mm
04-6141	3	mm	04-6163	25	mm
04-6142	4	mm	04-6164	26	mm
04-6143	5	mm	04-6165	1	1/2mm
04-6144	6	mm	04-6166	2	1/2mm
04-6145	7	mm	04-6167	3	1/2mm
04-6146	8	mm	04-6168	4	1/2mm
04-6147	9	mm	04-6169	5	1/2mm
04-6148	10	mm	04-6170	6	1/2mm
04-6149	11	mm	04-6171	7	1/2mm
04-6150	12	mm	04-6172	8	1/2mm
04-6151	13	mm	04-6173	9	1/2mm
04-6152	14	mm	04-6174	10	1/2mm
04-6153	15	mm	04-6175	11	1/2mm
04-6154	16	mm	04-6176	12	1/2mm
04-6155	17	mm	04-6177	13	1/2mm
04-6156	18	mm	04-6178	14	1/2mm
04-6157	19	mm	04-6179	15	1/2mm
04-6158	20	mm	04-6180	16	1/2mm
04-6159	21	mm	04-6181	17	1/2mm
04-6160	22	mm			

04-6139 - 04-6181  
HEGAR  
with very conical point  
185 mm

**AllWell Instruments co.**  
The name of Health Cure Instruments



1/2

04-6182 - 04-6190  
HEGAR  
205 mm

04-6182	1+2	mm
04-6183	3+4	mm
04-6184	5+6	mm
04-6185	7+8	mm
04-6186	9+10	mm
04-6187	11+12	mm
04-6188	13+14	mm
04-6189	15+16	mm
04-6190	17+18	mm



1/2

04-6191  
HEGAR  
Uterine dilator set, in canvas roll  
with 8 dilators.

## Uterine Dilators - Complete Sets



**04-6192**  
**HEGAR**  
 Dilator set consisting of:  
 14 Dilators,  
**(04-6193)**1 Rack for dilators ( 4 - 12 mm )  
**(04-6194)**1 Rack for Dilators ( 13 - 17 mm )  
**(04-6195)**1 Metal case only,  
 with hinged lid, stainless 200 X 100 X 35 mm



**AllWell Instruments co.**

The name of Health Care Instruments



**04-6196**  
**HEGAR**  
 Dilator set consisting of:  
 26 Dilators,  
**(04-6197)**1 Rack for dilators ( 1 - 17 mm )  
**(04-6198)**1 Rack for Dilators ( 18 - 26 mm )  
**(04-6199)**1 Metal case only,  
 with hinged lid, of aluminium 330 X 220 X 80 mm

## Endospecula For Cervix



**04-6200**  
KOGAN  
Endospecula for cervix  
and urethra, without ratchet  
240 mm



**04-6201**  
KOGAN  
Endospecula for cervix  
and urethra, with  
scale-ratchet and fixing screws  
240 mm



# Uterine Probes

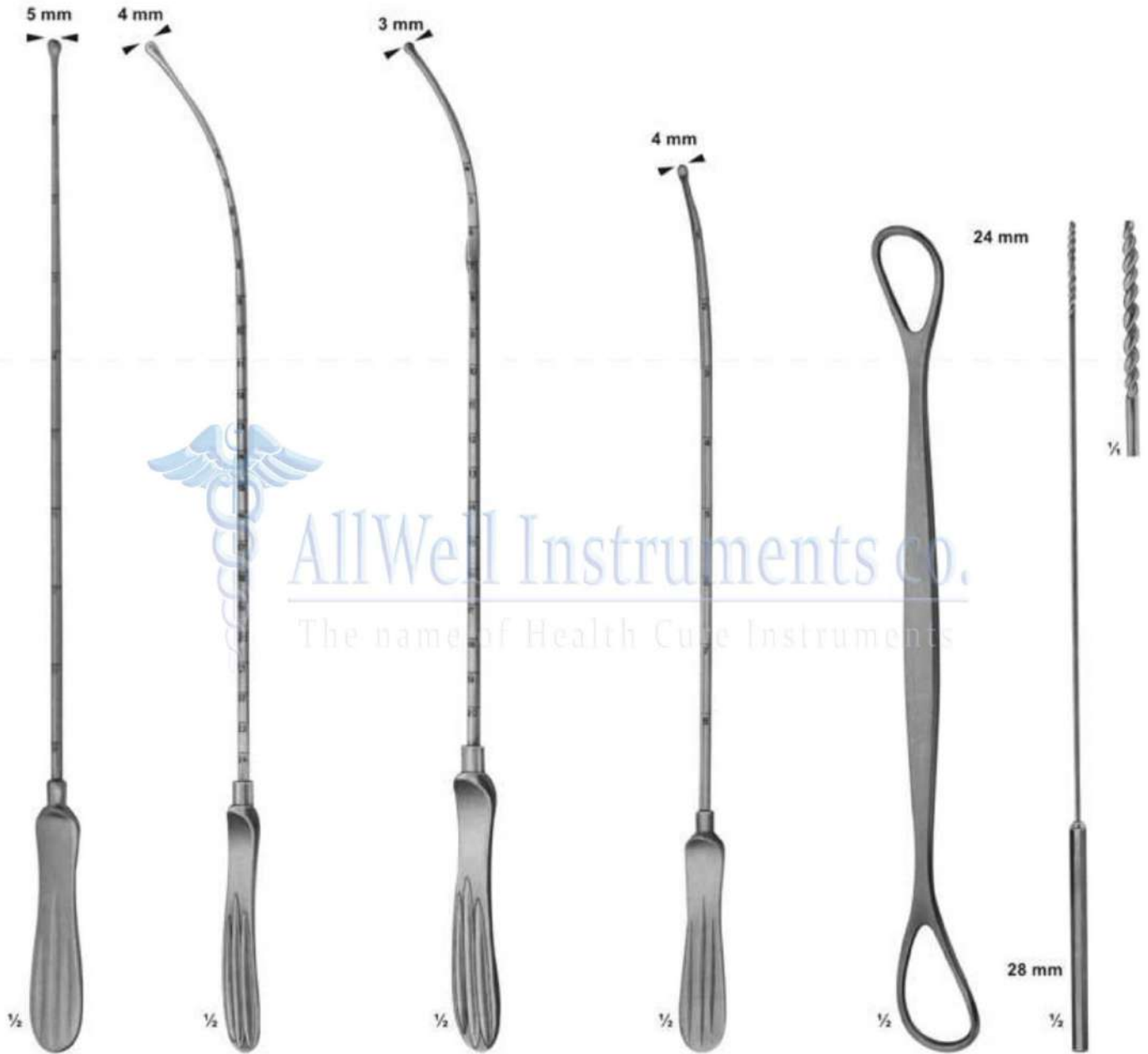

**04-6202**  
MAYO  
malleable  
330 mm

**04-6203**  
SIMS  
malleable  
330 mm  
**04-6204**  
SIMS  
330mm

**04-6205**  
MARTIN  
330 mm

**04-6206**  
SIMPSON  
malleable  
silver-plated  
290 mm

**04-6207**  
BRAUN  
Uterine  
depressor  
270 mm

**04-6208**  
Cotton  
applicator  
270 mm

## Uterine Dressing Forceps



Jaws with longitudinal groove

## Uterine Dressing Forceps





# Uterine Tenaculum Forceps

## Standard



**04-6216**  
BRAUN  
slender type  
250 mm



**04-6217**  
SCHROEDER  
250 mm



**04-6218**  
POZZI  
heavy type  
255 mm

# Uterine Tenaculum Forceps



**04-6219  
MARTIN**  
265 mm

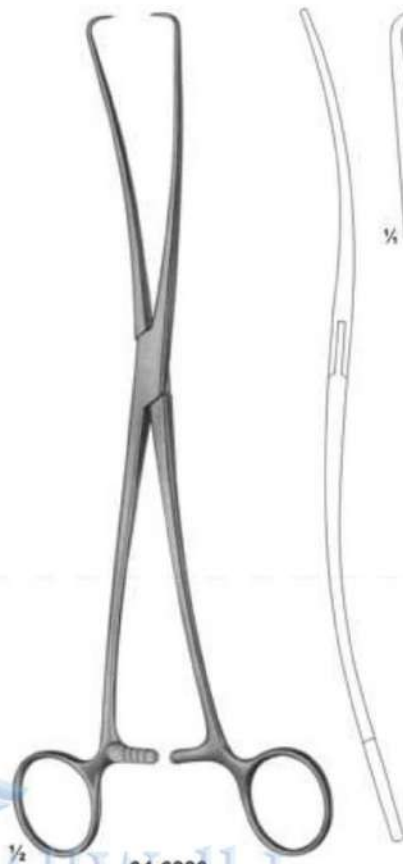

**04-6220  
DUPLAY**  
250 mm



**04-6221  
LAHEY**  
155 mm



**04-6222**  
straight

**04-6223**  
curved  
on flat

**04-6224**  
curved  
sideways

**04-6222 - 04-6224  
SCHROEDER**  
250 mm

# Uterine Tenaculum Forceps





# Uterine Tenaculum Forceps



**04-6229**  
JACOBS  
215 mm



**04-6230**  
LITTLEWOOD  
185 mm



**04-6231**  
MUSEUX  
200 mm

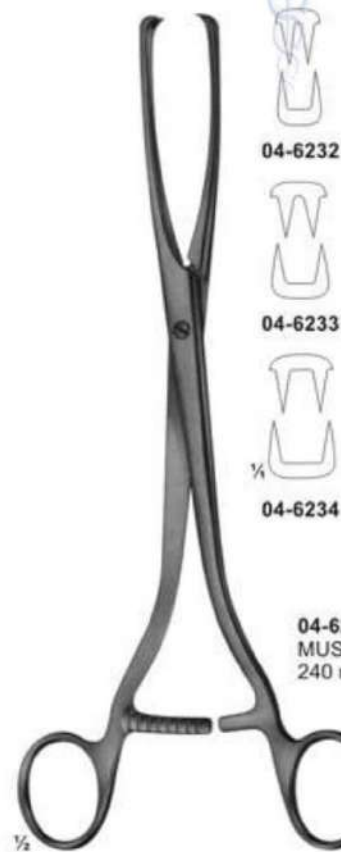

**04-6232**

**04-6233**

**04-6234**

**04-6232 - 04-6234**  
MUSEUX  
240 mm



**04-6235**

**04-6236**

1/2

**04-6235 - 04-6236**  
MUSEUX  
265 mm

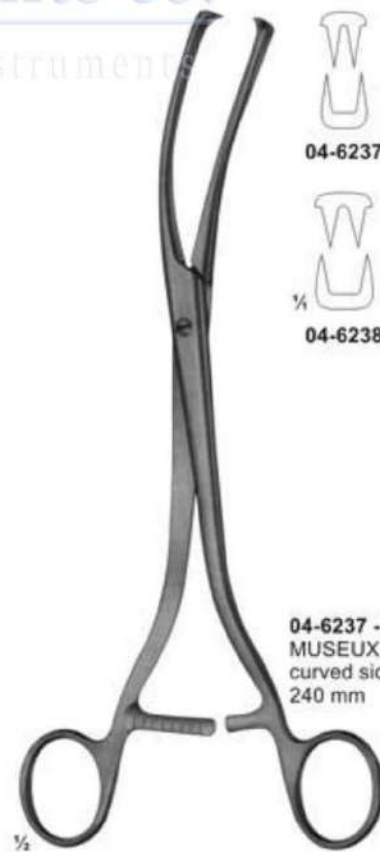

**04-6237**

**04-6238**

**04-6237 - 04-6238**  
MUSEUX  
curved sideways  
240 mm

## Polypus-and Ovum Forceps



**04-6239**  
**HEYWOOD-SMITH**  
 200 mm

**04-6240**  
**KELLY**  
 320 mm

**04-6241**  
**HEYWOOD-SMITH**  
 250 mm

**04-6242**  
**NOTO**  
 280 mm

## Polypus and Ovum Forceps

### Atraumata



1/4



1/4

04-6244  
250mm



1/4

04-6245  
270mm



1/4



1/2

04-6243  
DOYEN  
185 mm



AllWell Instruments Co.  
The name of Health Care Instruments



1/2

04-6244 - 04-6245



1/2

04-6246  
BUMM  
280 mm



## Uterine Elevating Forceps

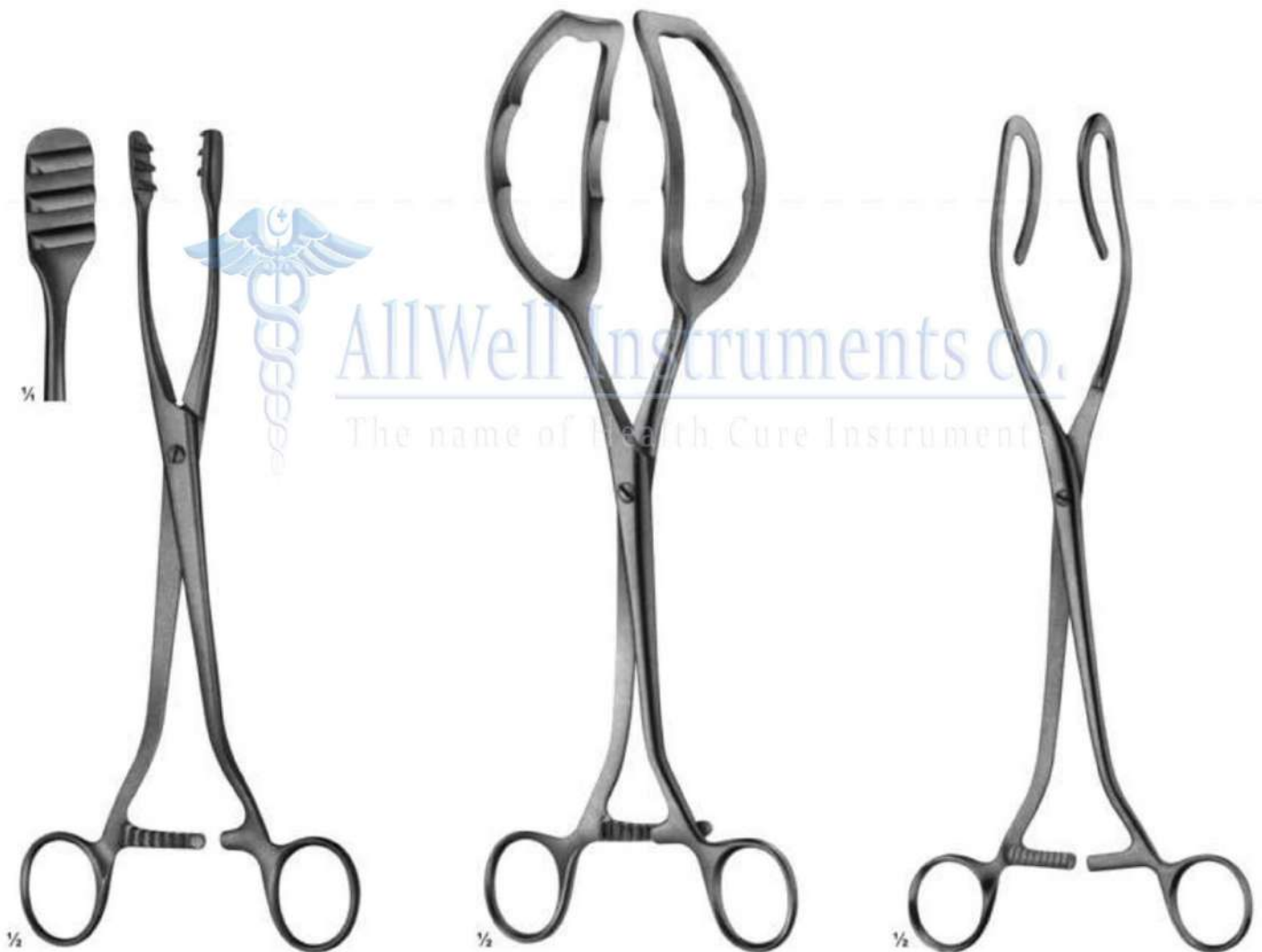

04-6247  
COLLIN  
250 mm

04-6248  
COLLIN  
285 mm

04-6249  
DARTIGUES  
255 mm

## Uterine Elevating Forceps



**04-6250**  
SOMER  
235 mm



**04-6251**  
STRASSMANN  
265 mm

## Uterine Elevating Forceps

With movable jaws



04-6252  
COLLIN  
265 mm

With movable jaws



04-6253  
APPREX  
approx. 260 mm



# Myoma Instruments, Instruments For Micro Tubal Operations



**04-6254**  
SEGOND  
Myomatome  
270 mm



**04-6255**  
DOYEN  
Myoma screw  
150 mm



**04-6256**  
DOYEN  
Myoma screw  
190 mm



**04-6257 04-6258 04-6259**  
∅ 6mm ∅ 8mm ∅ 10mm

**04-6257 - 04-6259**  
NEUBUSER  
Tubal seizing forceps  
200 mm

145 X 100 X 1.5 mm



**04-6263**  
Silicon operating pad  
pre-cut



**04-6260**  
Splint guide  
with thread



**04-6261**  
Splint guide with  
round handle  
180 mm



**04-6262**  
Angled glass rods  
Set . 3 pieces



**04-6264**  
Polyaethylen splint material  
soft-sterile  
0.45 mm

# Biopsy Curettes

**Malleable**

**Malleable**

**Stumpf blunt**

**Stumpf blunt**

**Luer-Lock**

**Luer-Lock**

**04-6265**  
ASCH  
Uterine  
Secretion scoop  
200 mm

**04-6266**  
Uterine  
Secretion scoop  
270 mm

**04-6267**  
NOVAK-SCHOECKAERT  
Endometrial biopsy  
curette  
240 mm

**04-6268**  
RANDALL  
Endometrial  
biopsy curette  
240 mm

## Biopsy Forceps

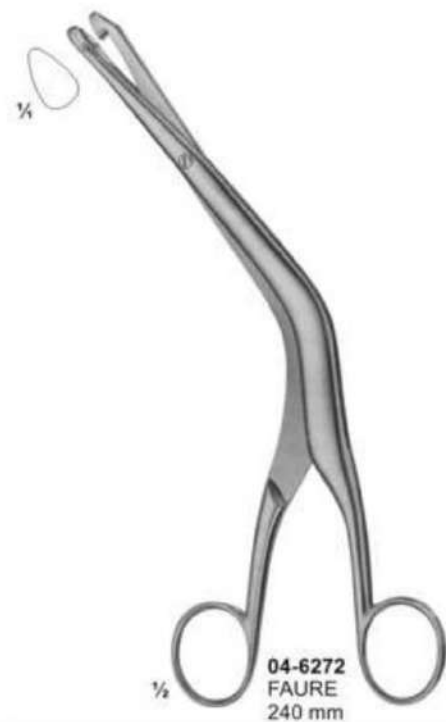



# Biopsy Forceps

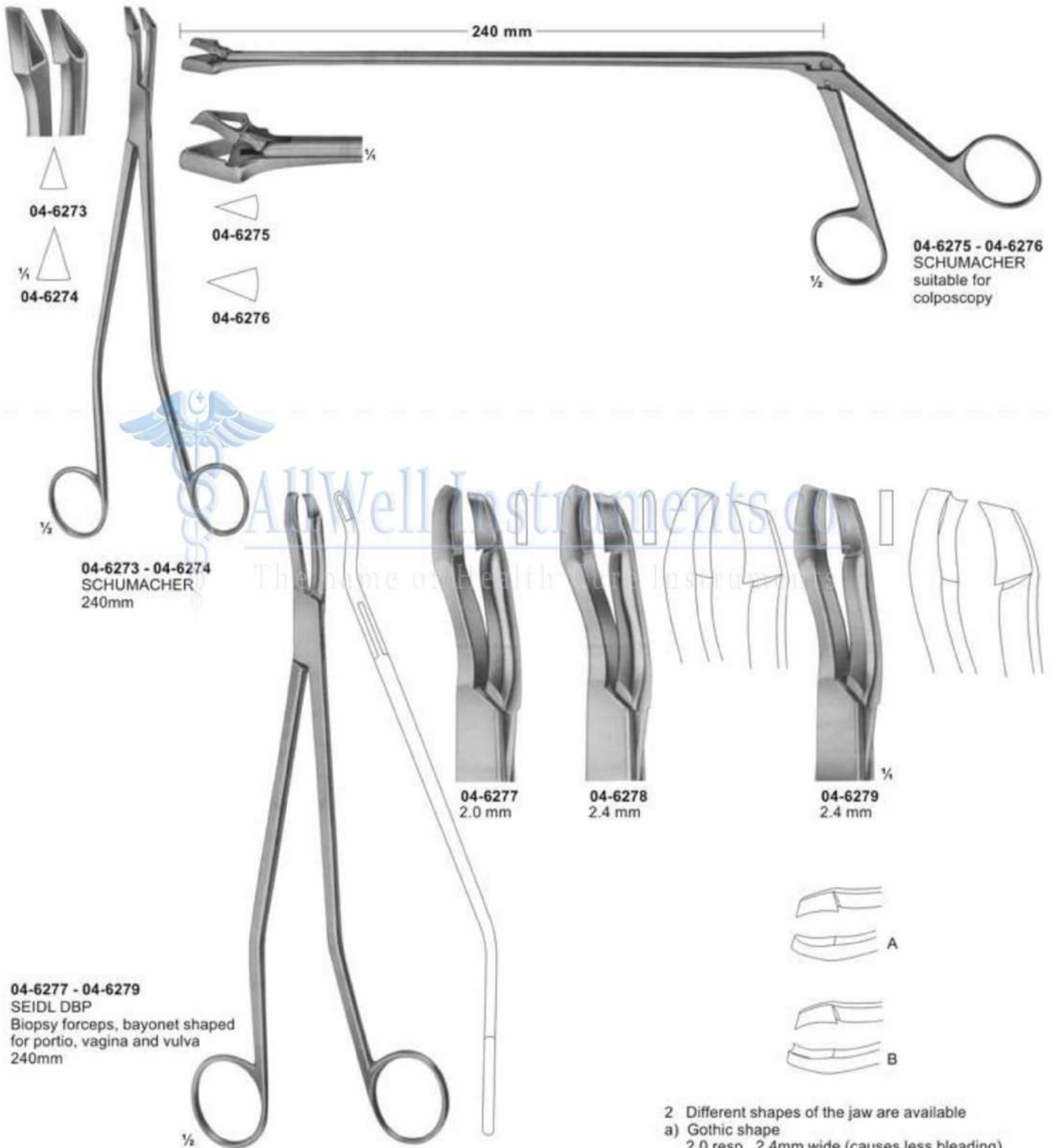

# Biopsy Forceps

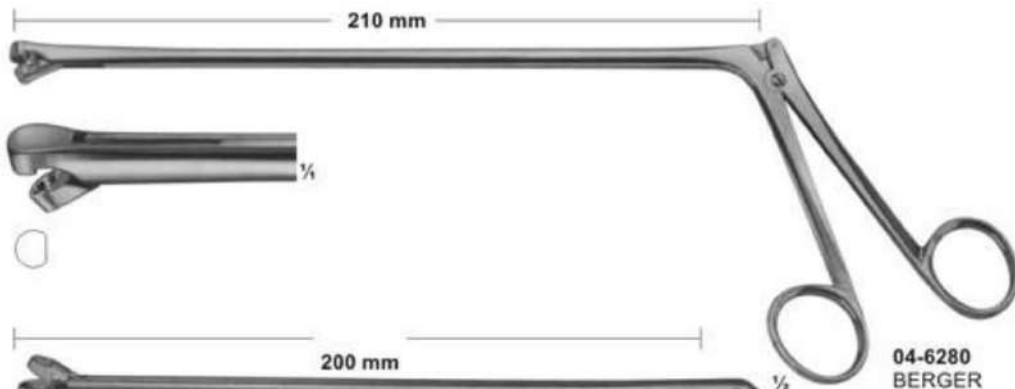

**04-6280 BERGER**

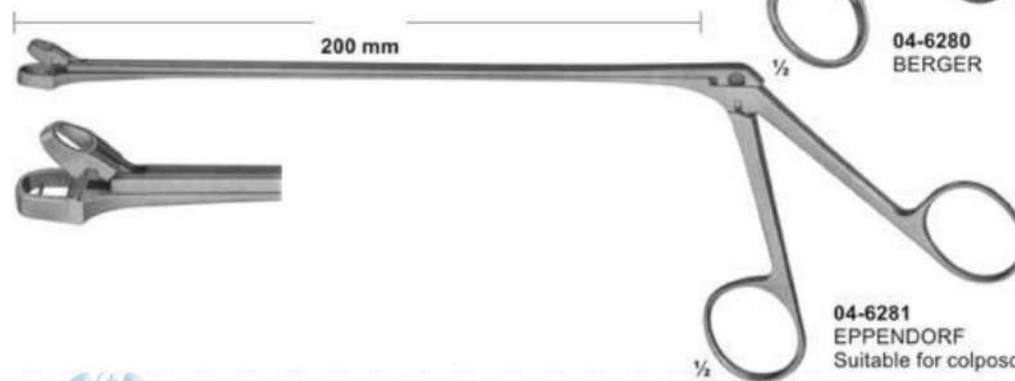

**04-6281 EPPENDORF**  
Suitable for colposcopy



**04-6282**

universal handle  
with drawing cut, beginning from the top

**04-6283**  
attachment only

**04-6282**  
for handle



**04-6282**  
140 mm



**04-6284 HUBER**  
140 mm

Extension cannulae

**04-6285 BRUENINGS** 200 mm Length  
**04-6286 BRUENINGS** 250 mm Length



**04-6287** **04-6288**

**04-6289 KRAUSE** ( Biopsy tip )



**04-6290 SCHEINMANN** ( Biopsy tip )



**04-6291 SCHUMACHER**  
( Biopsy tip ) with drawing cut

# Uterine Scoops

Fig	Width	Sharp		Blunt
		Rigid	Malleable	Rigid
00	4.5mm	<b>04-6294</b>		
0	7.5mm	<b>04-6295</b>		<b>04-6306</b>
1	8.5mm	<b>04-6296</b>	<b>04-6317</b>	<b>04-6307</b>
2	10.5mm	<b>04-6297</b>	<b>04-6318</b>	<b>04-6308</b>
3	12.0mm	<b>04-6298</b>	<b>04-6319</b>	<b>04-6309</b>
4	14.0mm	<b>04-6299</b>	<b>04-6320</b>	<b>04-6310</b>
5	15.0mm	<b>04-6300</b>	<b>04-6321</b>	<b>04-6311</b>
6	16.5mm	<b>04-6301</b>	<b>04-6322</b>	<b>04-6312</b>
7	18.0mm	<b>04-6302</b>	<b>04-6323</b>	<b>04-6313</b>
8	19.5mm	<b>04-6303</b>	<b>04-6324</b>	<b>04-6314</b>
9	21.5mm	<b>04-6304</b>		<b>04-6315</b>
10	23.5mm	<b>04-6305</b>		<b>04-6316</b>

**04-6294- 04-6305** Sharp - Rigid  
**04-6317- 04-6324** Sharp - Malleable  
**04-6306- 04-6316** Blunt - Rigid

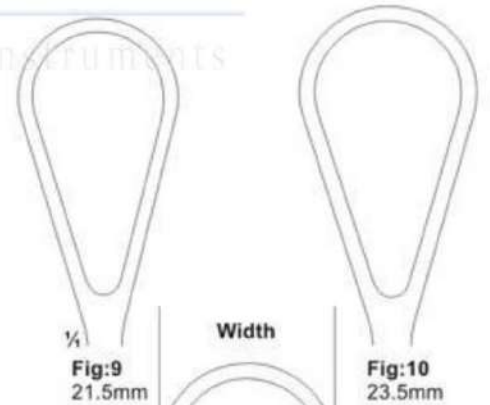
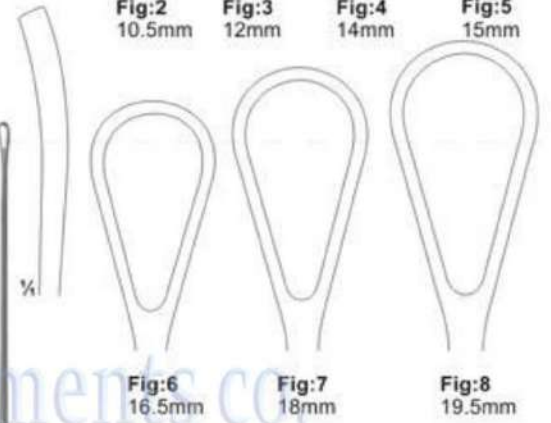
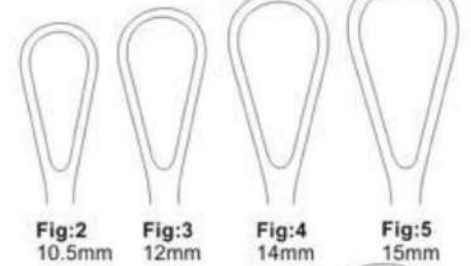



# Uterine Curettes

Fig	Width	Sharp		Blunt
		Rigid	Malleable	Rigid
1	7.5mm	04-6325	04-6331	04-6337
2	8.5mm	04-6326	04-6332	04-6338
3	10.5mm	04-6327	04-6333	04-6339
4	12.0mm	04-6328	04-6334	04-6340
5	14.0mm	04-6329	04-6335	04-6341
6	15.0mm	04-6330	04-6336	04-6342

04-6325 - 04-6330 Sharp - Rigid  
 04-6331 - 04-6336 Sharp - Malleable  
 04-6337 - 04-6342 Blunt - Rigid

Fig	Width	Blunt - Malleable
0	16.5mm	04-6343
1	18.5mm	04-6344
2	19.5mm	04-6345
3	21.5mm	04-6346
4	23.5mm	04-6347
5	26.0mm	04-6348
6	28.5mm	04-6349

**BUMM**

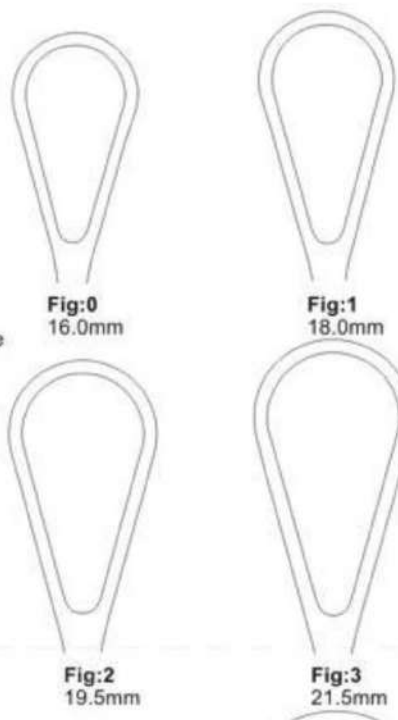

# Placenta-and Ovum Curettes

Fig	Width	Sharp Malleable	Blunt Malleable
1	23.5mm	<b>04-6354</b>	<b>04-6356</b>
2	26.0mm		<b>04-6357</b>
3	28.5mm	<b>04-6355</b>	<b>04-6358</b>



**04-6351**  
COLLIN  
300 mm



**04-6352 - 04-6353**  
RECAMIER  
blunt-rigid  
max. 360 mm



Fig:1



Fig:2



**04-6354 - 04-6358**  
BUMM  
max. 310 mm  
**04-6354 - 04-6355**  
**04-6356 - 04-6358**



Fig:1



Fig:2



Fig:3

## Vacuum Currettes

### 04-6359 - 04-6364

Suction currettes, stainless steel, fitting hose connection.

Working tips are smoothly rounded off, therefore no danger of perforation.



( suitable for suction biopsy )

04-6359: diam 4 mm

04-6360: diam 6 mm

04-6361: diam 8 mm

04-6362: diam 10 mm

04-6363: diam 12 mm

04-6364: diam 14 mm

### 04-6365

Hose connection inside diam. 11 mm, curved, stainless steel.



The new connection between suction currette and hose connection, (04-6365) Guarantees quick changing and free turning of the suction currettes on the hose connection.

### 04-6366

Transparent suction hose 1.8 mm long, inside diam 11 mm, outside diam 16.5 mm can be sterilized in an autoclave at 1 bar overpressure ( 120° C )

### 04-6367

Strainer for tissues, plastic, for single use only, to be used for histopathological examination.





# Gynaecological Instruments



1/2  
**04-6368** diam 8 mm  
**04-6369** diam 10 mm  
**BOZEMANN-FRITSCH**  
Uterine Flushing Tube  
350 mm



**04-6371**



**AllWell Instruments co.**  
The name of Health Care Instruments

- 04-6370** SCHULZE  
Salpingograph, for utero-salpingography  
in wooden case, consisting of:
- 04-6371** Manometer only
- 04-6372** Connection only, without manometer
- 04-6373** Uterine cannula with tape without cone
- 04-6374** Cone only, small
- 04-6375** Cone only, medium
- 04-6376** Cone only, large
- 04-6377** Record syringe, 10CC, luer-lock mount.

**04-6373**



**04-6374**



**04-6375**



**04-6376**



**04-6377**



- 04-6378** SCHULZE  
Salpingograph, equipment like(04-6370)  
but without manometer.



## Obstetrics-Pelvimeters



**04-6379**  
**THOLE**  
 for internal and external measurements, graduated in centimeters

**04-6380**  
**DE LEE**  
 graduated in centimeters and inches

**04-6381**  
**COLLIN**  
 graduated in centimeters

**04-6382**  
**MARTIN**  
 graduated in centimeters

for internal measurements between symphysis and promontory

**04-6383**  
**SCHNEIDER**  
 graduated in centimeters

The additional straight arm can be replaced. The pelvimeter with straight arm is used for localisation of the portio vaginalis uteri and of vaginal metastasis.

**04-6384**  
**BREISKY**  
 graduated in centimeters

## Forceps For Obstetrics



04-6385  
HERFF  
membrane puncturing  
forceps  
255 mm



04-6386  
IOWA  
membrane puncturing  
forceps  
260 mm



# Scissors of Obstetrics, Umbilical cord clamp



**04-6387**  
SCHUMACHER  
Umbilical cord  
scissors  
155 mm



**04-6388**  
Umbilical cord  
scissors  
105 mm



**04-6389**  
145 mm

**04-6390**  
200 mm

**04-6389 - 04-6390**  
BRAUN-STADLER  
Episiotomy Scissors

**04-6391**  
Episiotomy Scissors  
240 mm

## Obstetrics - Obstetrical Forceps



04-6392  
NAEGELE  
355 mm



04-6393  
NAEGELE  
400 mm



04-6394  
SIMPSON-BRAUN  
305mm

## Obstetrics - Obstetrical Forceps



1/2

**04-6395**  
SIMPSON-BRAUN  
350mm

For caesarean section



1/2

**04-6396**  
SIMPSON  
235mm

For caesarean section



1/2

**04-6397**  
WRIGLEY  
250 mm

AllWell Instruments co.  
The name of Health Care Instruments



# Obstetrics Forceps

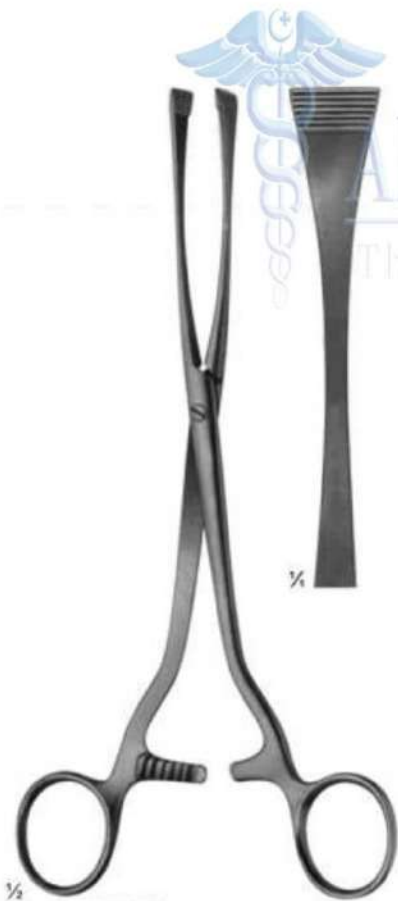

**04-6398**  
**GREEN-ARMYTAGE**  
Caesarean section haemostatic  
forceps, for edges of the transverse  
incision in the lower segment  
220 mm



**04-6399**  
**WILLETT**  
Scalp Flap forceps  
185 mm



**04-6400**  
**GAUSS**  
Scalp Flap forceps  
260 mm

# Obstetrics-Placenta and Ovum Forceps



Fig: 1  
04-6401

Fig: 2  
04-6402

Fig: 3  
04-6403

Fig: 1  
04-6404

Fig: 2  
04-6405

Fig: 3  
04-6406

1/2  
04-6401 - 04-6403  
WINTER  
290 mm

1/2  
04-6404 - 04-6406  
WINTER  
290 mm

1/2  
04-6407  
SAENGER  
275 mm

## Obstetrics-Placenta and Ovum Forceps

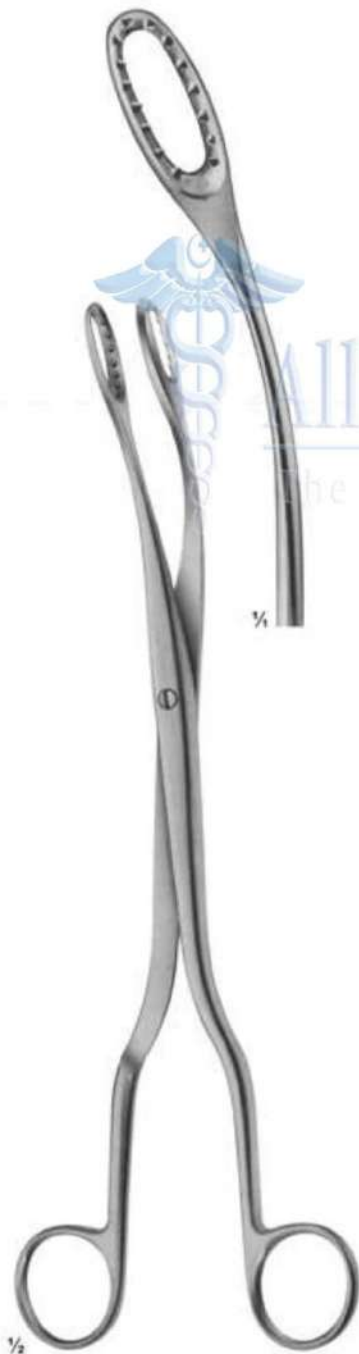

**04-6408**  
**SAENGER**  
 285 mm



**04-6409**  
**SAENGER**  
 265 mm



**04-6410 - 04-6411**  
**LEWKOWITZ**  
 245 mm



# Obstetrics-Placenta and Ovum Forceps, Perforator, Cranioclast



04-6412  
KELLY  
320mm



04-6413  
SMELLIE  
Perforator  
270mm

1 jaws fenestrated



04-6414  
BRAUN  
Cranioclast  
420mm



# Section - 05

AllWell Instruments Co.

The name of Health Care Instrument



**Pages 255-318**

- ★ Tracheotomy, Cardiovascular & Thoracic Surgery
- ★ Bone Punches & Rongeurs



# Tracheal Tubes with inner tubes

Fig.	0	1	2	3	4	5	6	7	8	9	10
∅ mm	4	5	6	7	8	9	10	11	12	13	14
Charr./Fr.	12	15	18	21	24	27	30	33	36	39	42



**05-7001**  
UECKERMANN-DENKER  
Cryothyrotomy trocar  
with silver cannula  
130mm

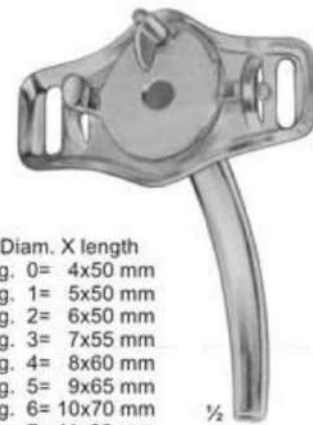

Diam. X length  
**05-7002** Fig. 0= 4x50 mm  
**05-7003** Fig. 1= 5x50 mm  
**05-7004** Fig. 2= 6x50 mm  
**05-7005** Fig. 3= 7x55 mm  
**05-7006** Fig. 4= 8x60 mm  
**05-7007** Fig. 5= 9x65 mm  
**05-7008** Fig. 6= 10x70 mm  
**05-7009** Fig. 7= 11x80 mm  
**05-7010** Fig. 8= 12x85 mm  
**05-7011** Fig. 9= 13x90 mm  
**05-7012** Fig. 10=14x90 mm

**05-7002 - 05-7012**  
LUER  
German silver



**05-7013 - 05-7022**  
JACKSON  
German Silver

AllWell Instruments co.

The name of Health Care Instruments

Diam. X length  
**05-7013** Fig. 0= 4x50 mm  
**05-7014** Fig. 1= 5x48 mm  
**05-7015** Fig. 2= 6x58 mm  
**05-7016** Fig. 3= 7x70 mm  
**05-7017** Fig. 4= 8x78 mm  
**05-7018** Fig. 5= 9x84 mm  
**05-7019** Fig. 6= 10x84 mm  
**05-7020** Fig. 7= 11x86 mm  
**05-7021** Fig. 8= 12x88 mm  
**05-7022** Fig. 9= 13x90 mm



Diam. X length **05-7023 - 05-7032**  
**05-7023** Fig. 1= 5x48 mm JACKSON  
**05-7024** Fig. 2= 6x58 mm Stainless Steel  
**05-7025** Fig. 3= 7x70 mm  
**05-7026** Fig. 4= 8x78 mm  
**05-7027** Fig. 5= 9x84 mm  
**05-7028** Fig. 6= 10x84 mm  
**05-7029** Fig. 7= 11x86 mm  
**05-7030** Fig. 8= 12x88 mm  
**05-7031** Fig. 9= 13x90 mm  
**05-7032** Fig.10= 14x90 mm



## Wound-and Tracheal Hooks and Dilators



**AllWell Instruments co.**

The name of Health Care Instruments

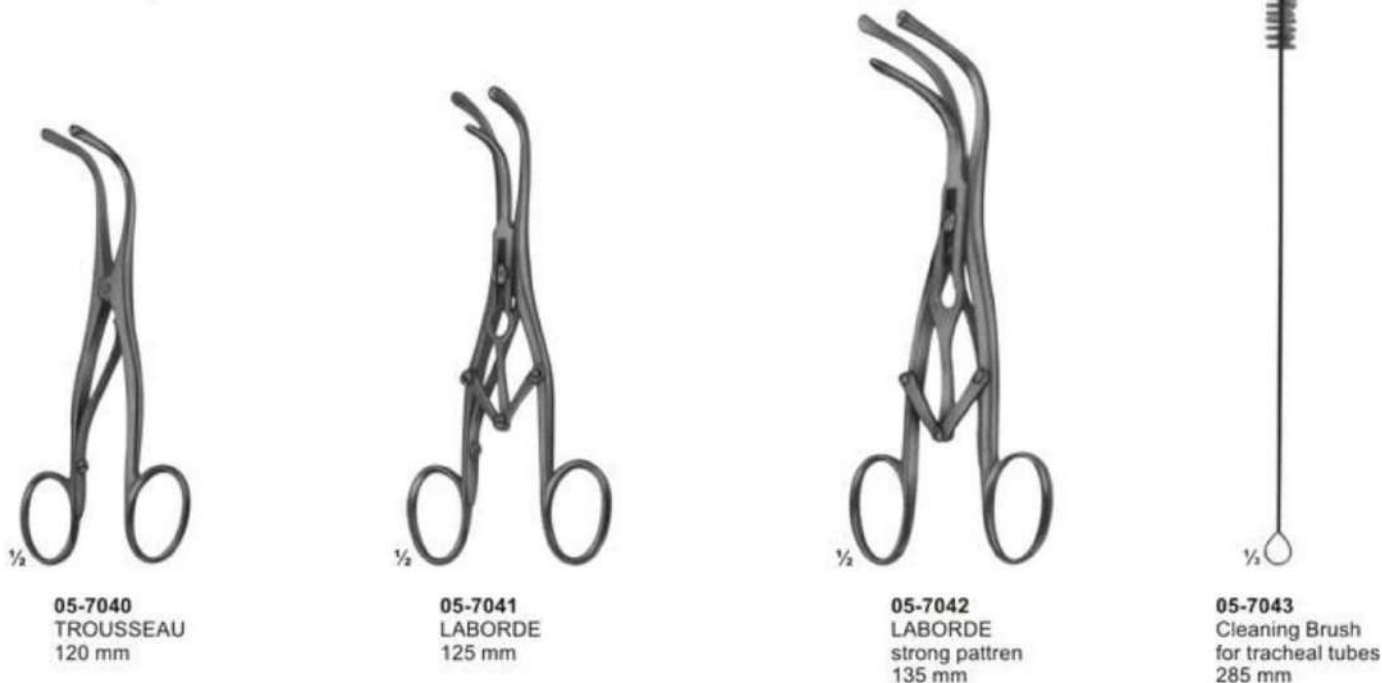

# Irrigating Cannulae, Embolus Grasping Forceps, Dilators

**Ø 3 mm 4 mm 5 mm 6 mm**

**05-7044 05-7045 05-7046 05-7047**

**Luer Lock**

**05-7044 - 05-7047**  
**SCHMID**  
Vessel irrigating cannulae,  
malleable, silver plated  
150 mm

**05-7048**  
**BLAKE**  
Embolus grasping  
forceps  
205 mm

**05-7049 - 05-7060**  
**DE BAKEY**  
Vascular dilators,  
malleable  
190 mm

**05-7049 05-7050 05-7051 05-7052 05-7053 05-7054**

**05-7055 05-7056 05-7057 05-7058 05-7059 05-7060**

<b>05-7049</b>	0,5 mm Ø	<b>05-7055</b>	3,5 mm Ø
<b>05-7050</b>	1,0 mm Ø	<b>05-7056</b>	4,0 mm Ø
<b>05-7051</b>	1,5 mm Ø	<b>05-7057</b>	4,5 mm Ø
<b>05-7052</b>	2,0 mm Ø	<b>05-7058</b>	5,0 mm Ø
<b>05-7053</b>	2,5 mm Ø	<b>05-7059</b>	7,0 mm Ø
<b>05-7054</b>	3,0 mm Ø	<b>05-7060</b>	9,0 mm Ø

# Vascular Spatulas

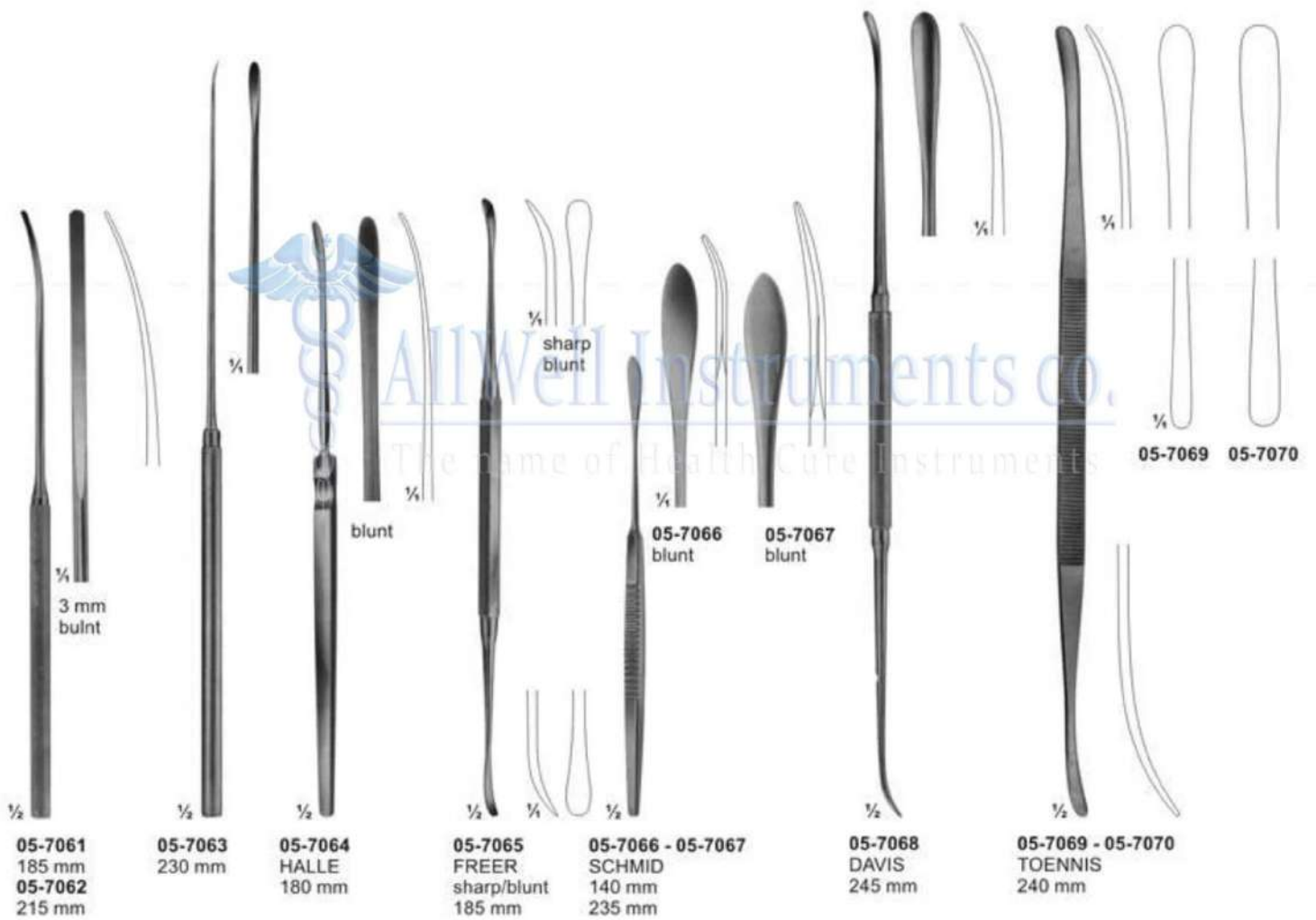



# Endarterectomy Strippers, Tourniquets

- 05-7071  
2 mm
- 05-7072  
3 mm
- 05-7073  
4mm
- 05-7074  
6mm
- 05-7075  
7mm

- 05-7076  
8,5mm
- 05-7077  
10mm
- 05-7078  
12mm
- 05-7079  
14mm

- ⌋  
05-7083
- ⌋  
05-7084



05-7071 - 05-7079  
Endarterectomy strippers  
550 mm



05-7080  
Handle for  
110 mm



05-7081 - 05-7082  
RUMEL-BELMONT  
325 mm  
05-7081 - 4,0 mm Ø  
05-7082 - 6,4 mm Ø

05-7083 - 05-7084  
Guide only

## Bioptome and Aortic Dilators

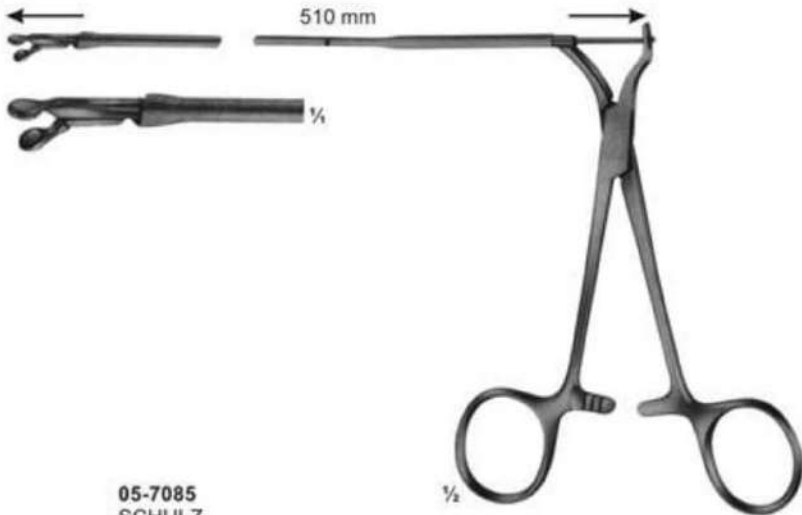

**05-7085  
SCHULZ**  
Bioptome, with flexible Shaft, 510 mm long,  
with round jaws 3 mm diam.

Biopsy forceps, for biopsy from the right atrium  
through cava jugularis, prior to heart implantations.



**05-7087  
COOLEY**  
Dilator for  
mitral valve  
for children

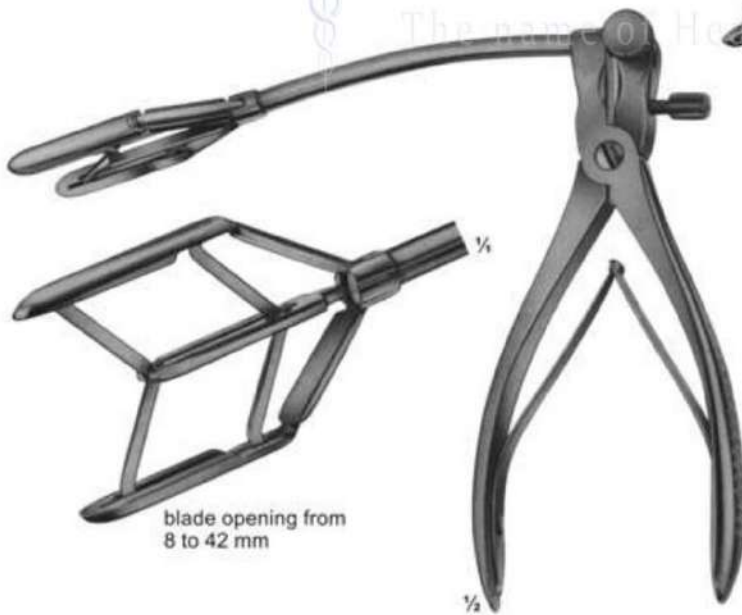

**05-7086  
TUBBS**  
Dilator for  
mitral valve

# JENKER Instrument Set For Tunnelling And Pulling-Through Vascular Grafts Toothings

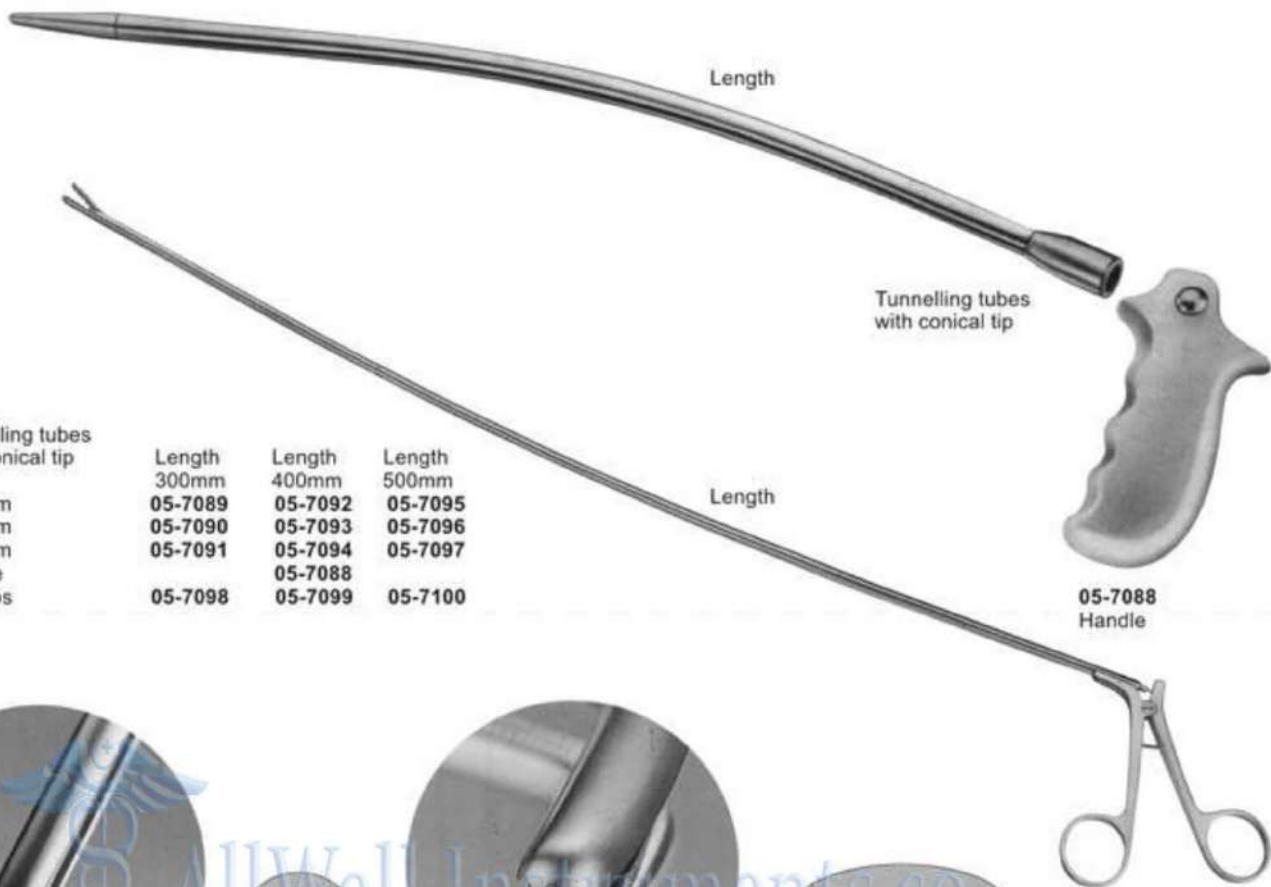

Tunnelling tubes with conical tip	Length 300mm	Length 400mm	Length 500mm
∅ 12mm	05-7089	05-7092	05-7095
∅ 14mm	05-7090	05-7093	05-7096
∅ 17mm	05-7091	05-7094	05-7097
Handle	05-7098	05-7088	
Forceps		05-7099	05-7100

**05-7088**  
Handle

**05-7098**  
Forceps



**DE BAKEY**  
05-7101  
1 : 2 rows of teeth



**DE BAKEY**  
05-7102  
2 : 3 rows of teeth

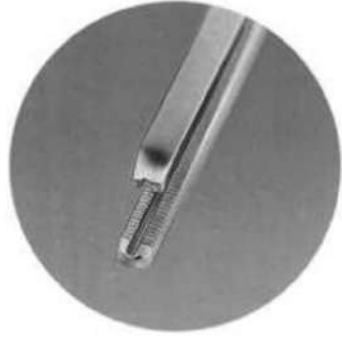

**COOLEY**  
05-7103  
2 : 2 rows of teeth

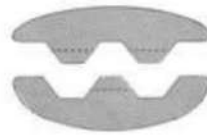
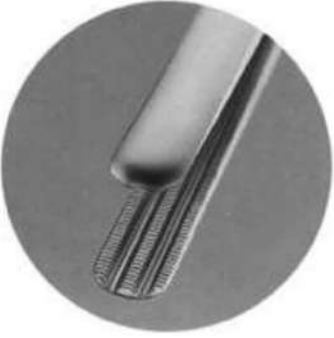

**DARDIK**  
05-7104  
2 : 3 rows of teeth



# Atraumata Ultra-Light-Forceps



**05-7105**  
 Width of jaws 1.2 mm  
 Length 150mm



**05-7106**  
 Width 1.5 mm  
 Length 200 mm



**05-7107**  
 Width 1.5 mm  
 Length 240 mm



**05-7108**  
 Width 1.5 mm  
 Length 300 mm

# Atraumata Dissecting Forceps

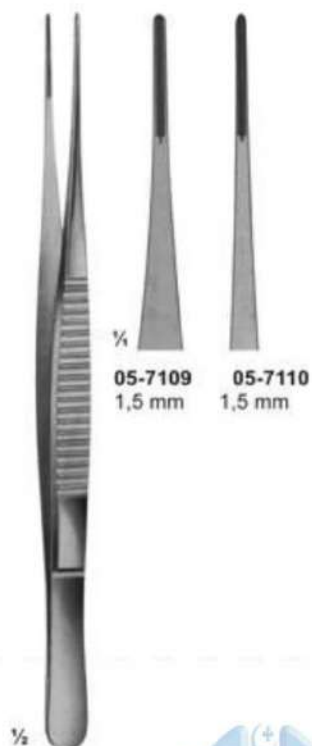

1/4  
**05-7109** 1,5 mm  
**05-7110** 1,5 mm

1/2  
**05-7109 - 05-7110**  
DE BAKEY  
150 mm  
300 mm

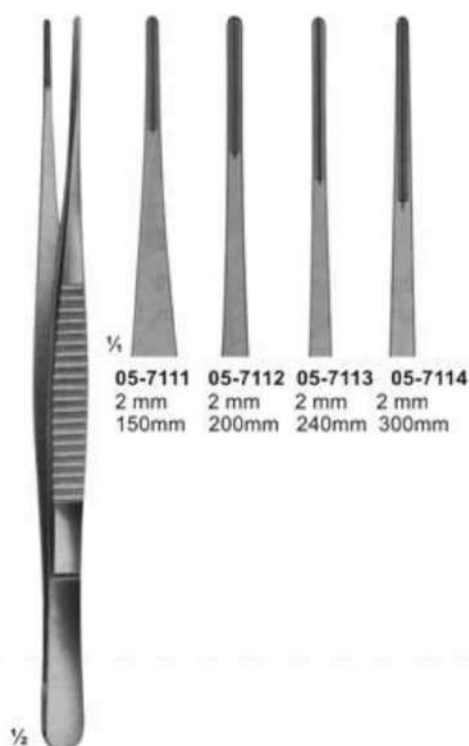

1/4  
**05-7111** 2 mm 150mm  
**05-7112** 2 mm 200mm  
**05-7113** 2 mm 240mm  
**05-7114** 2 mm 300mm

1/2  
**05-7111 - 05-7114**  
DE BAKEY

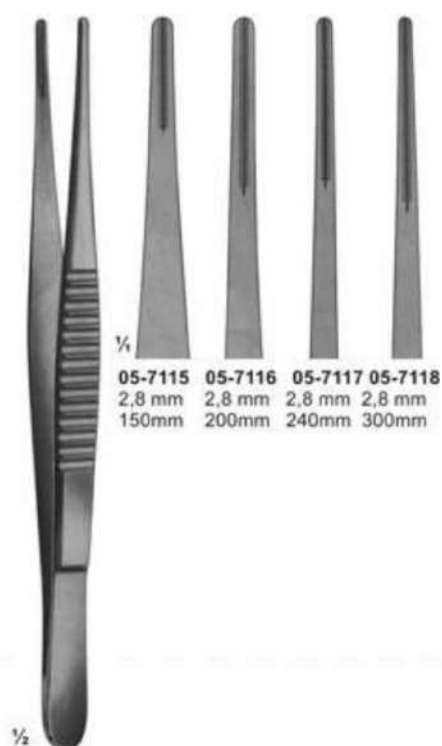

1/4  
**05-7115** 2,8 mm 150mm  
**05-7116** 2,8 mm 200mm  
**05-7117** 2,8 mm 240mm  
**05-7118** 2,8 mm 300mm

1/2  
**05-7115 - 05-7118**  
DE BAKEY

**AllWell Instruments co.**

The name of Health Cure Instrument

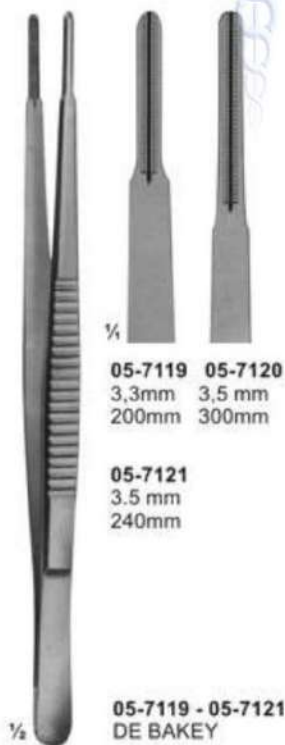

1/4  
**05-7119** 3,3mm 200mm  
**05-7120** 3,5 mm 300mm

**05-7121**  
3,5 mm  
240mm

1/2  
**05-7119 - 05-7121**  
DE BAKEY

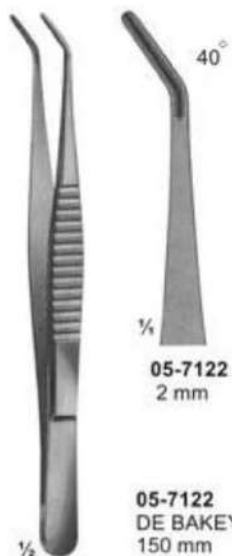

40°  
1/4  
**05-7122**  
2 mm

1/2  
**05-7122**  
DE BAKEY  
150 mm

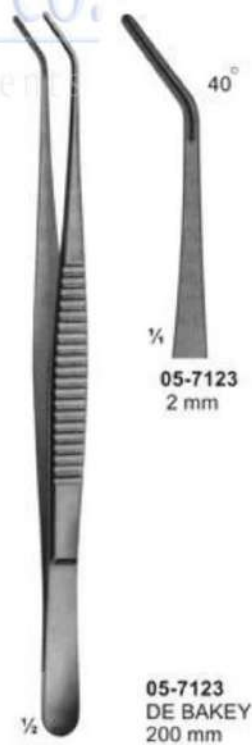

1/4  
**05-7123**  
2 mm

1/2  
**05-7123**  
DE BAKEY  
200 mm

# Atraumata Ring Handle Bulldog Clamps



**05-7124**  
DE-BAKEY  
straight  
130 mm

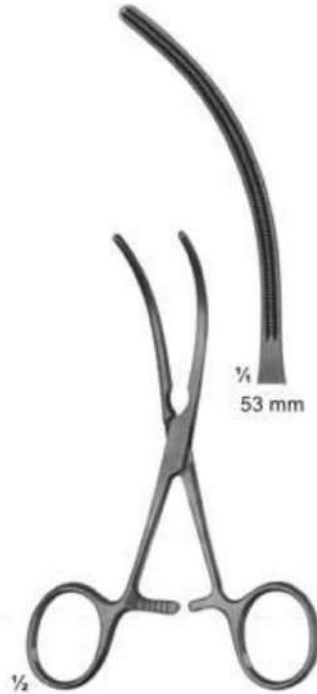

**05-7125**  
DE-BAKEY  
curved jaws  
125 mm

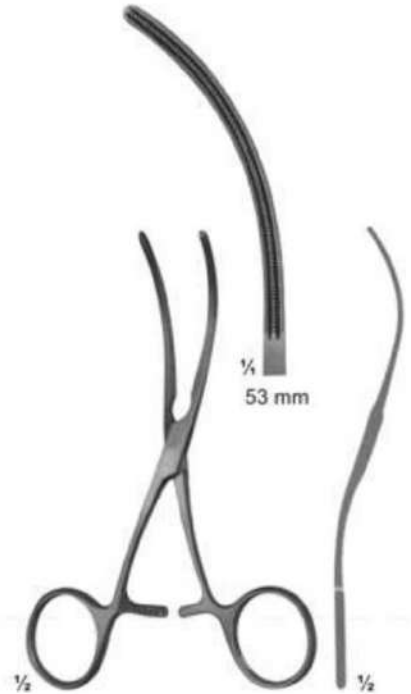

**05-7126**  
DE-BAKEY  
S-shaped curved  
125 mm



**AllWell Instruments co.**

The name of Health Cure Instruments

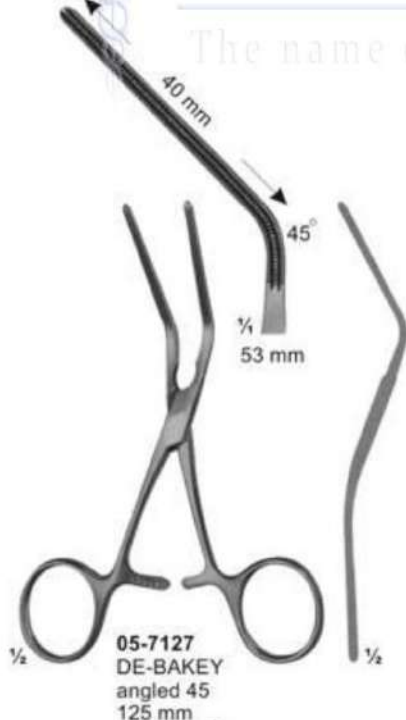

**05-7127**  
DE-BAKEY  
angled 45  
125 mm

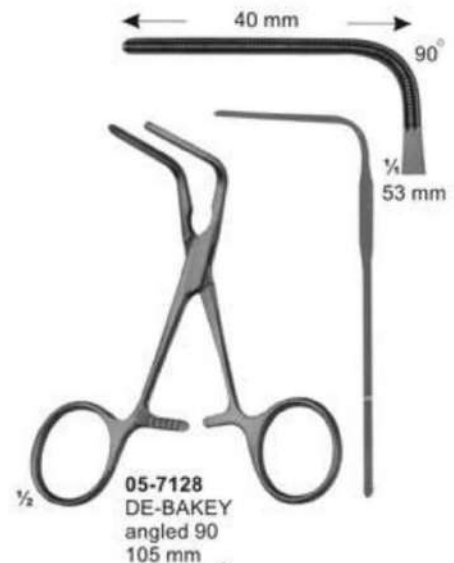

**05-7128**  
DE-BAKEY  
angled 90  
105 mm



# Atraumata Anastomosis and Multi-Purpose-Clamps for Neonatales

graduated



1/2

05-7129 - 05-7132  
CASTANEDA

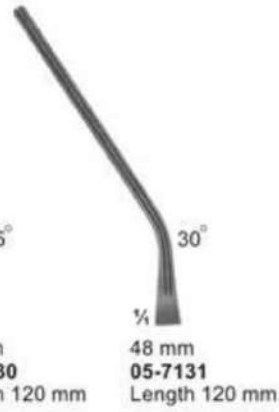
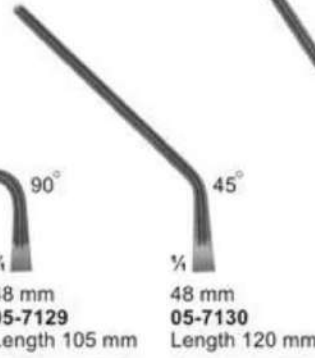

**AllWell Instruments co.**  
The name of Health Cure Instruments

graduated



1/2

05-7133 - 05-7136  
CASTANEDA

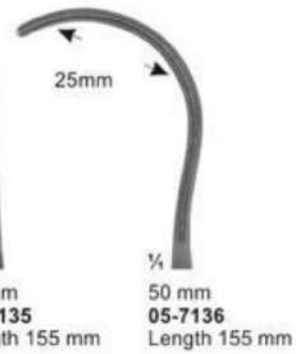
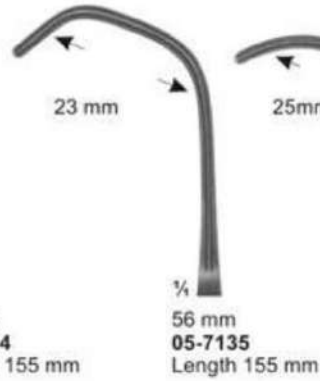
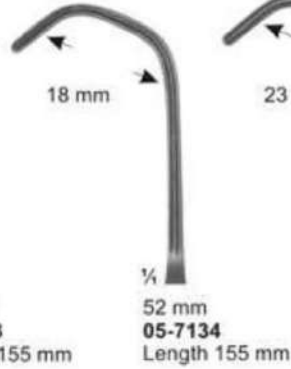
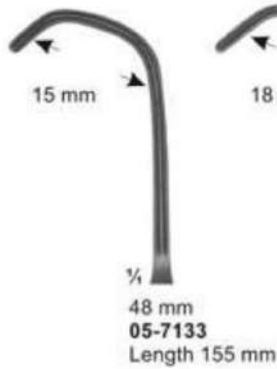

# Atraumata Anastomosis-and Multi-Purpose Clamps-Pediatric types

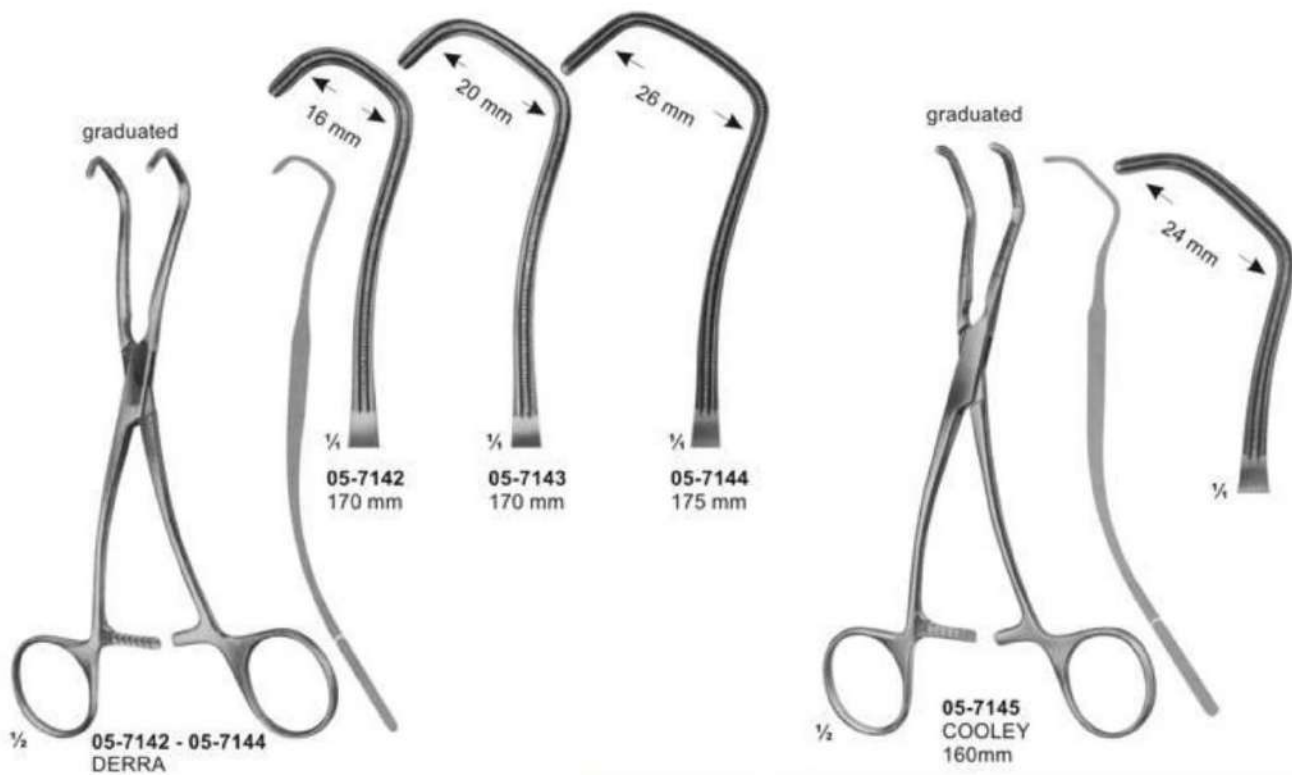
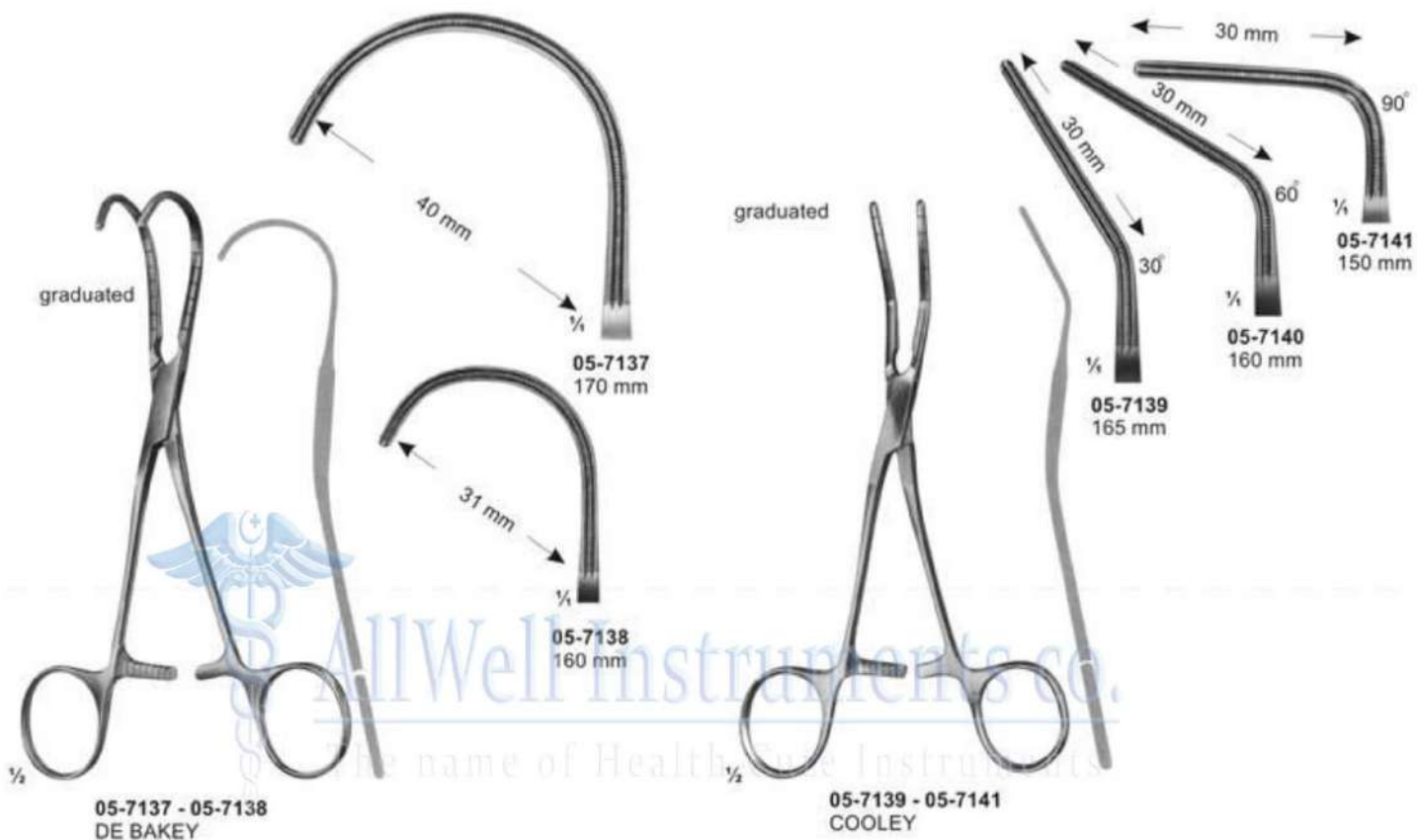

# Atraumata Non-traumatic Haemostatic Forceps

## Mosquito Forceps

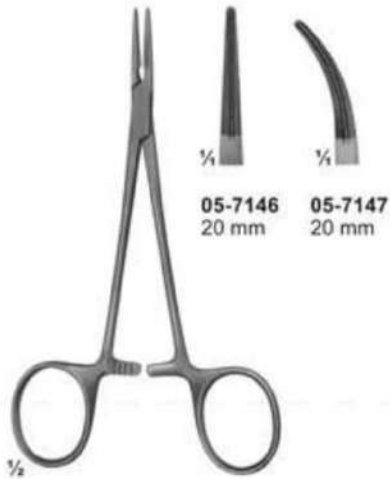

**05-7146 - 05-7147**  
125 mm



**05-7148 - 05-7149**  
165 mm



**05-7150 - 05-7151**  
DE BAKEY-BAINBRIDGE  
155 mm



**05-7152 - 05-7153**  
DE BAKEY-BAINBRIDGE  
180 mm

 **AllWell Instruments co.**  
The name of Health Care Instruments



# Atraumata Non-traumatic Haemostatic Forcep



**05-7154 - 05-7155**  
DE-BAKEY-KELLY  
140 mm



**05-7156 - 05-7157**  
PEAN  
155 mm



**05-7158 - 05-7163**  
DE-BAKEY-PEAN DE-BAKEY-PEAN  
05-7158 200 mm 05-7161 200 mm  
05-7159 265 mm 05-7162 260 mm  
05-7160 280 mm 05-7163 275 mm

# Atraumata Dissecting And Ligature Forceps Anastomosis Clamps

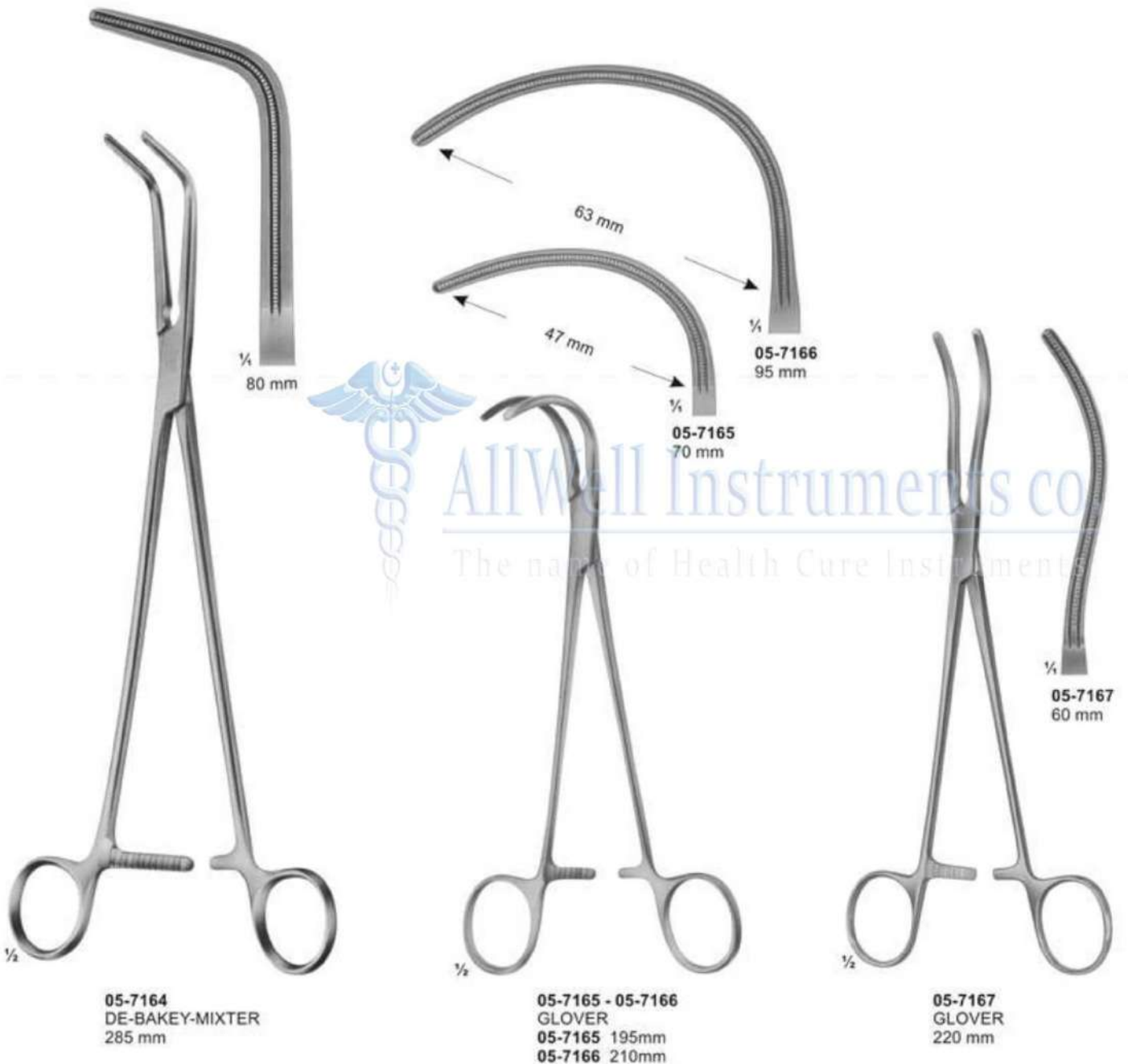

# Atraumata Anastomosis, Vena-Cava Clamps

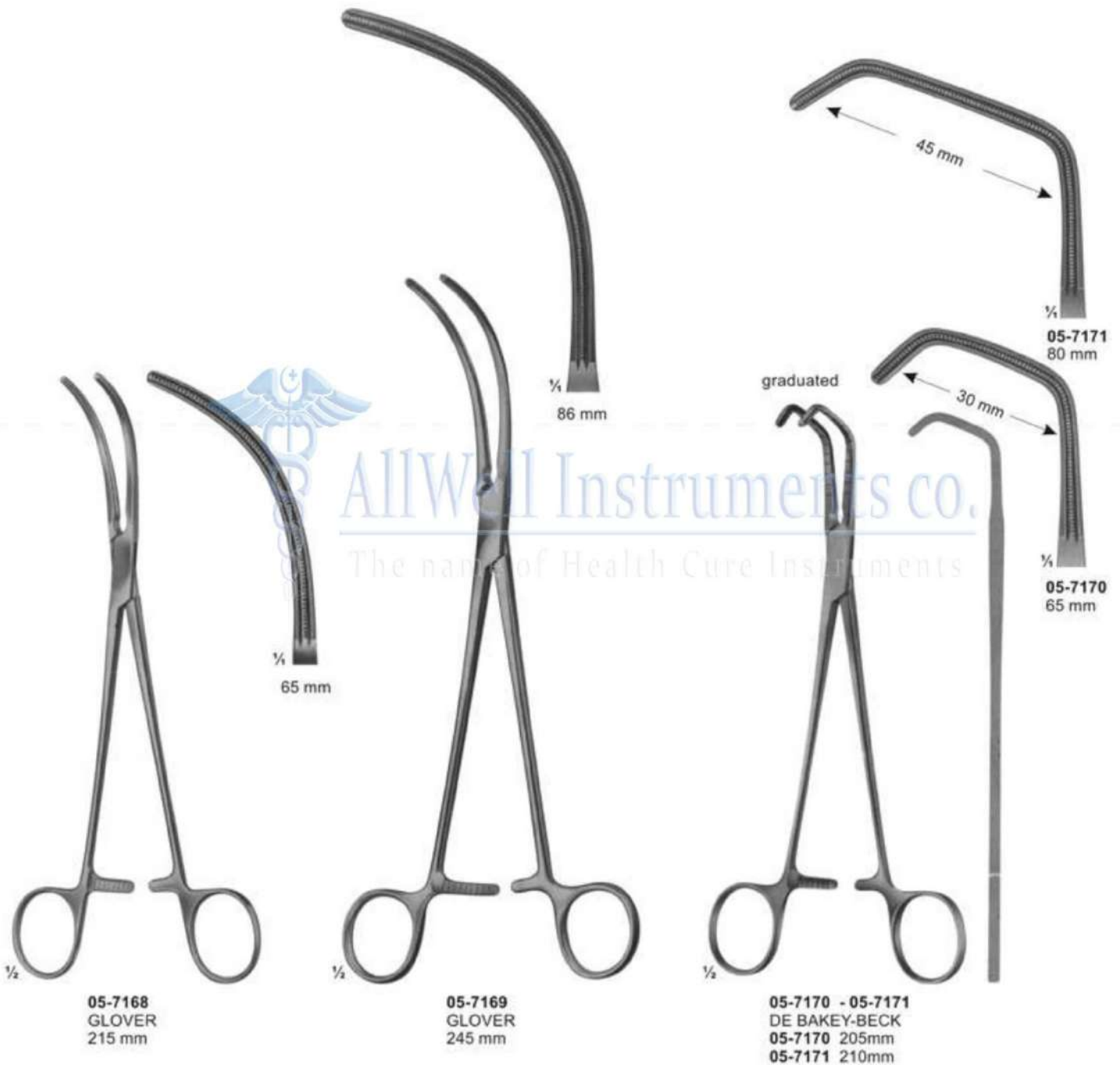



# Atraumata Vena-Cava Clamps And Tangential Occlusion Clamps

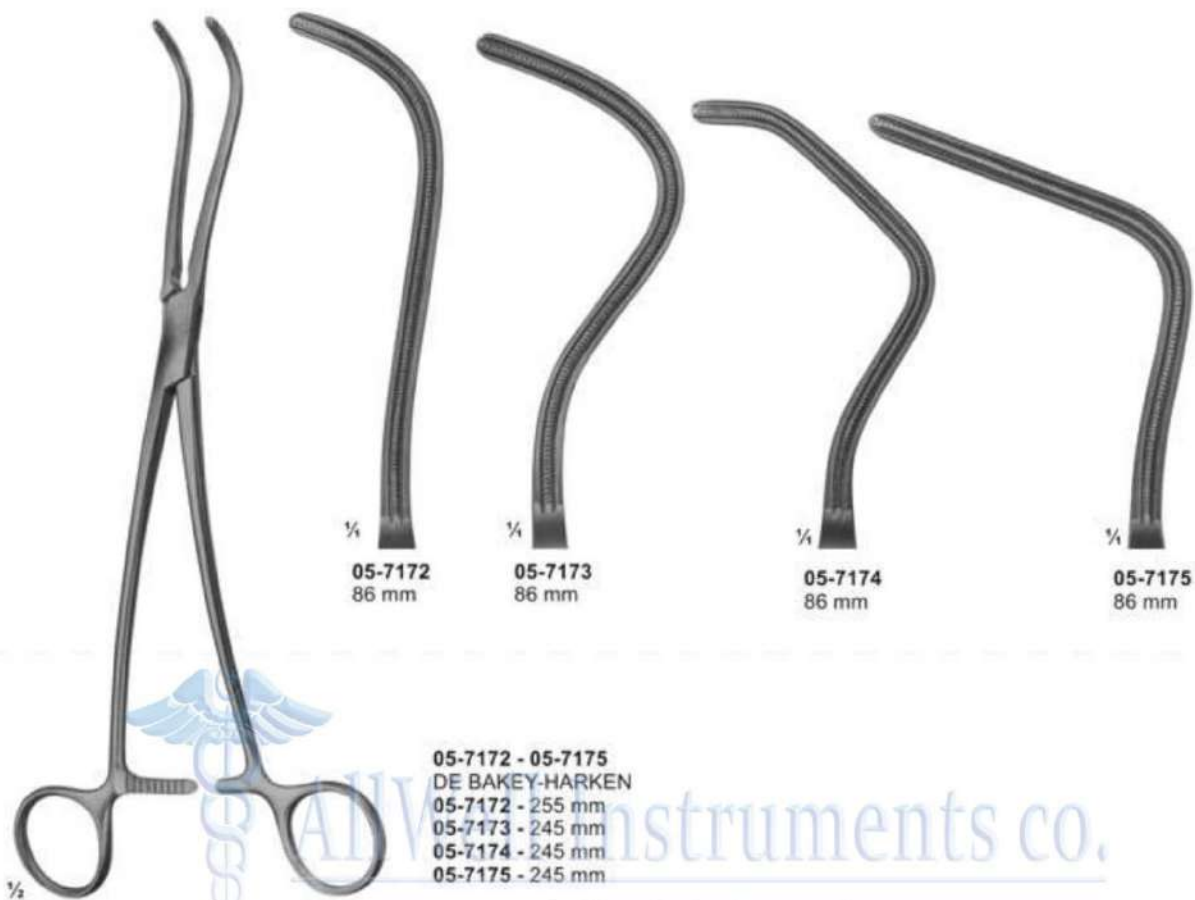

05-7172 - 05-7175  
DE BAKAY-HARKEN  
05-7172 - 255 mm  
05-7173 - 245 mm  
05-7174 - 245 mm  
05-7175 - 245 mm

**AllWell Instruments co.**  
The name of Health Cure Instruments

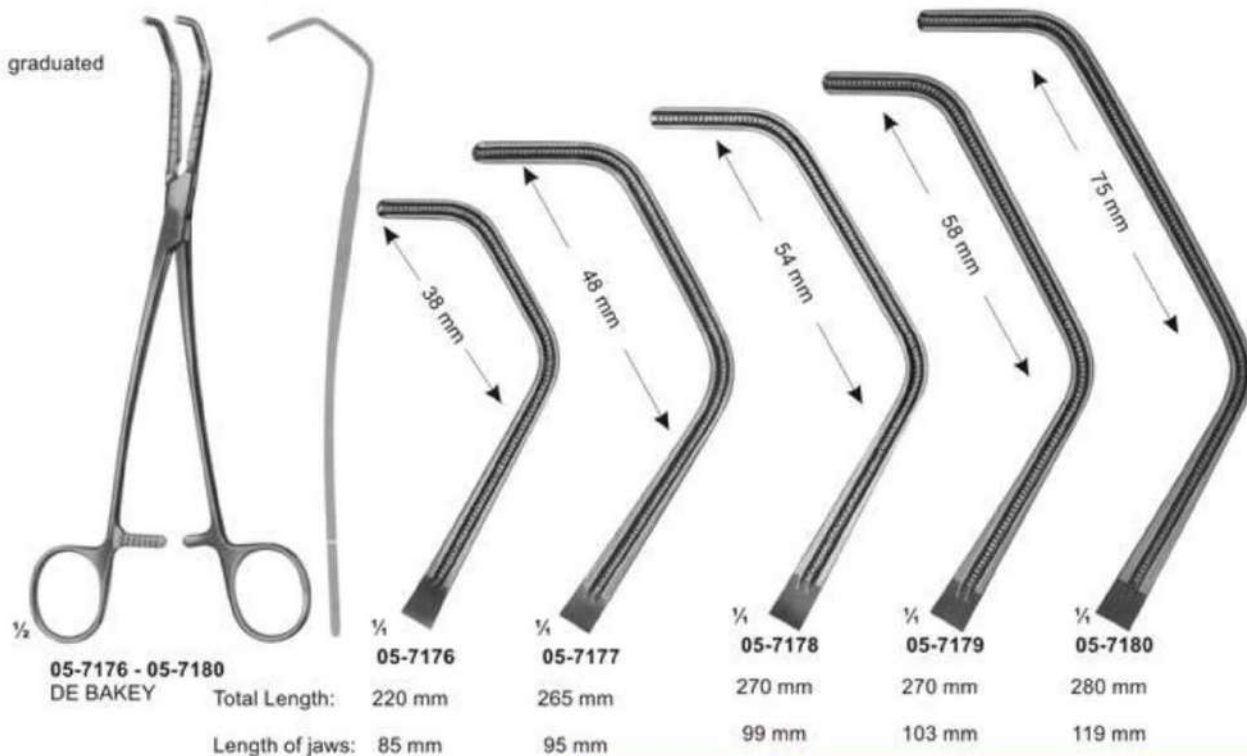

05-7176 - 05-7180  
DE BAKAY

Total Length:

Length of jaws:

05-7176

220 mm

85 mm

05-7177

265 mm

95 mm

05-7178

270 mm

99 mm

05-7179

270 mm

103 mm

05-7180

280 mm

119 mm

# Atraumata Tangential Occlusion And Coarctation Clamps



05-7181 - 05-7183  
DE BAKY-SATINSKY

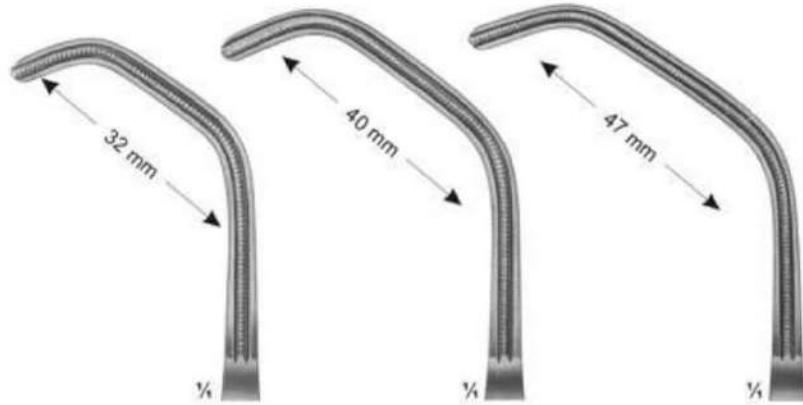

05-7181  
68 mm  
Length 235mm

05-7182  
76 mm  
Length 240mm

05-7183  
84 mm  
Length 245mm

AllWell Instruments co.

The name of Health Care Instruments



05-7184 - 05-7185  
DE BAKY  
05-7184 170mm  
05-7185 165mm



05-7184  
50 mm

05-7185  
50 mm

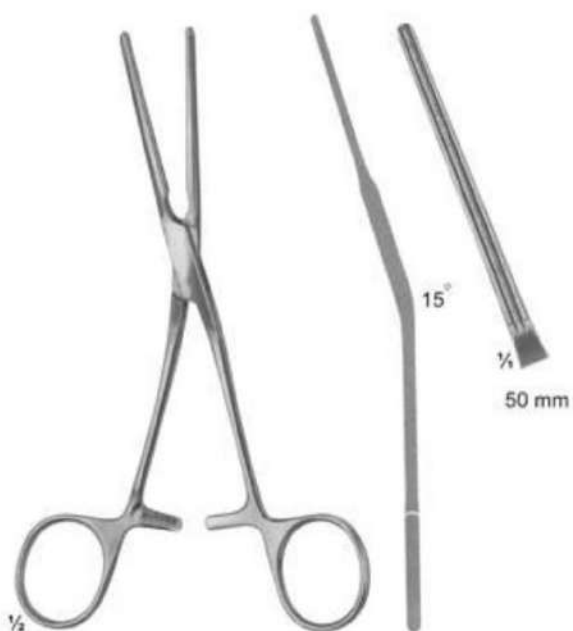

05-7186  
DE BAKY  
165 mm

50 mm

# Atraumata Coarctation Clamps, Patent-Ducts Clamps





# Atraumata Peripheral-Vascular Clamps



**05-7196**  
**DE BAKEY**  
190 mm

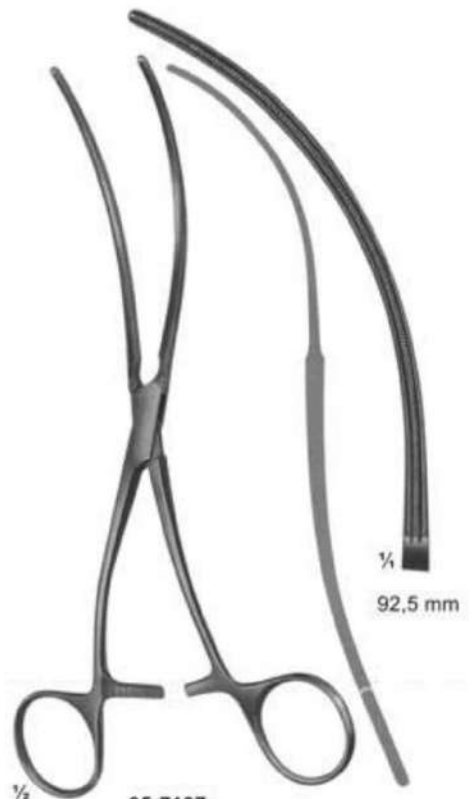

**05-7197**  
**DE BAKEY**  
200 mm

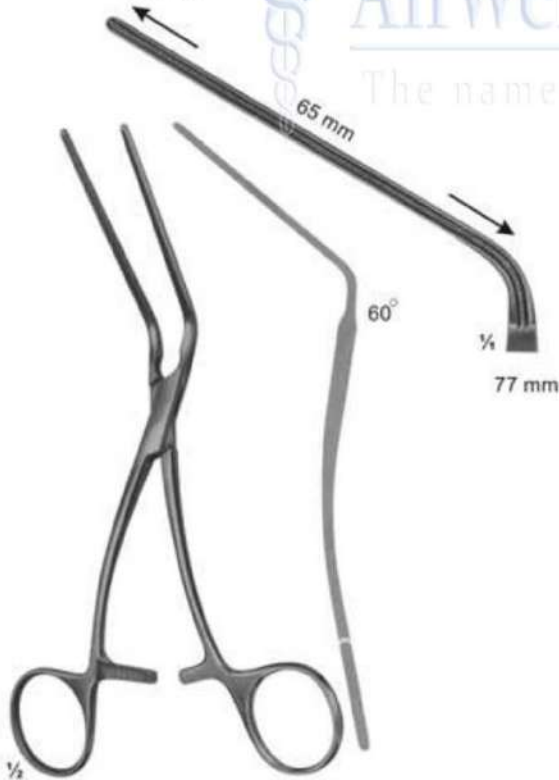

**05-7198**  
**DE BAKEY**  
180 mm



**05-7199 - 05-7200**  
**LELAND-JONES**  
190 mm

AllWell Instruments co.  
The name of Health Care Instruments

# Atraumata Peripheral Vascular And Anastomosis Clamps



**05-7201**  
LELAND-JONES  
195 mm



**05-7202**  
DE BAKEY  
200 mm



**05-7203**  
WERTHEIM  
250 mm

# Atraumata Anastomosis And Ascending Aotra Cross Clamps

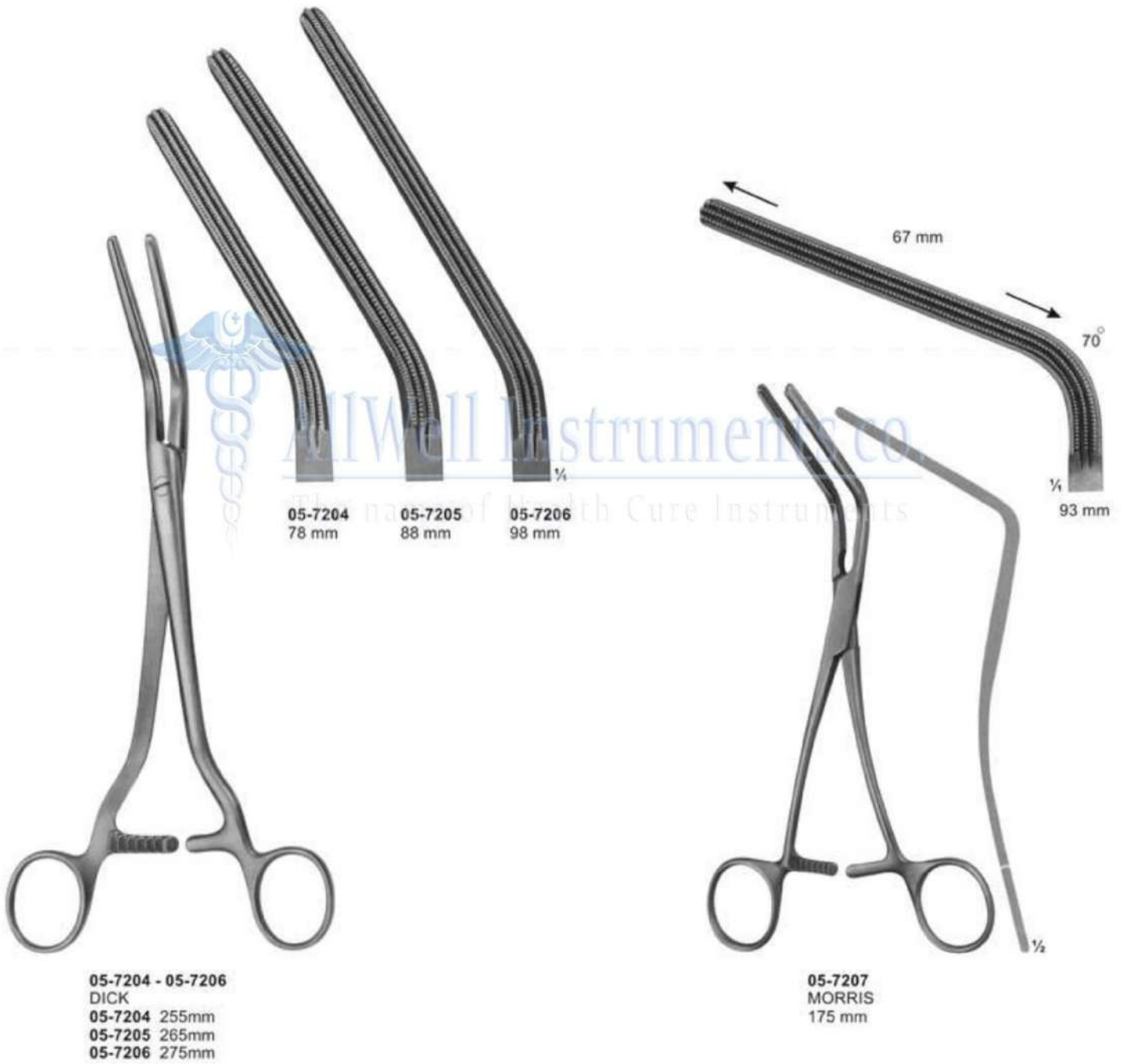



# Atraumata Ascending Aorta Cross, Bronchus Clamps

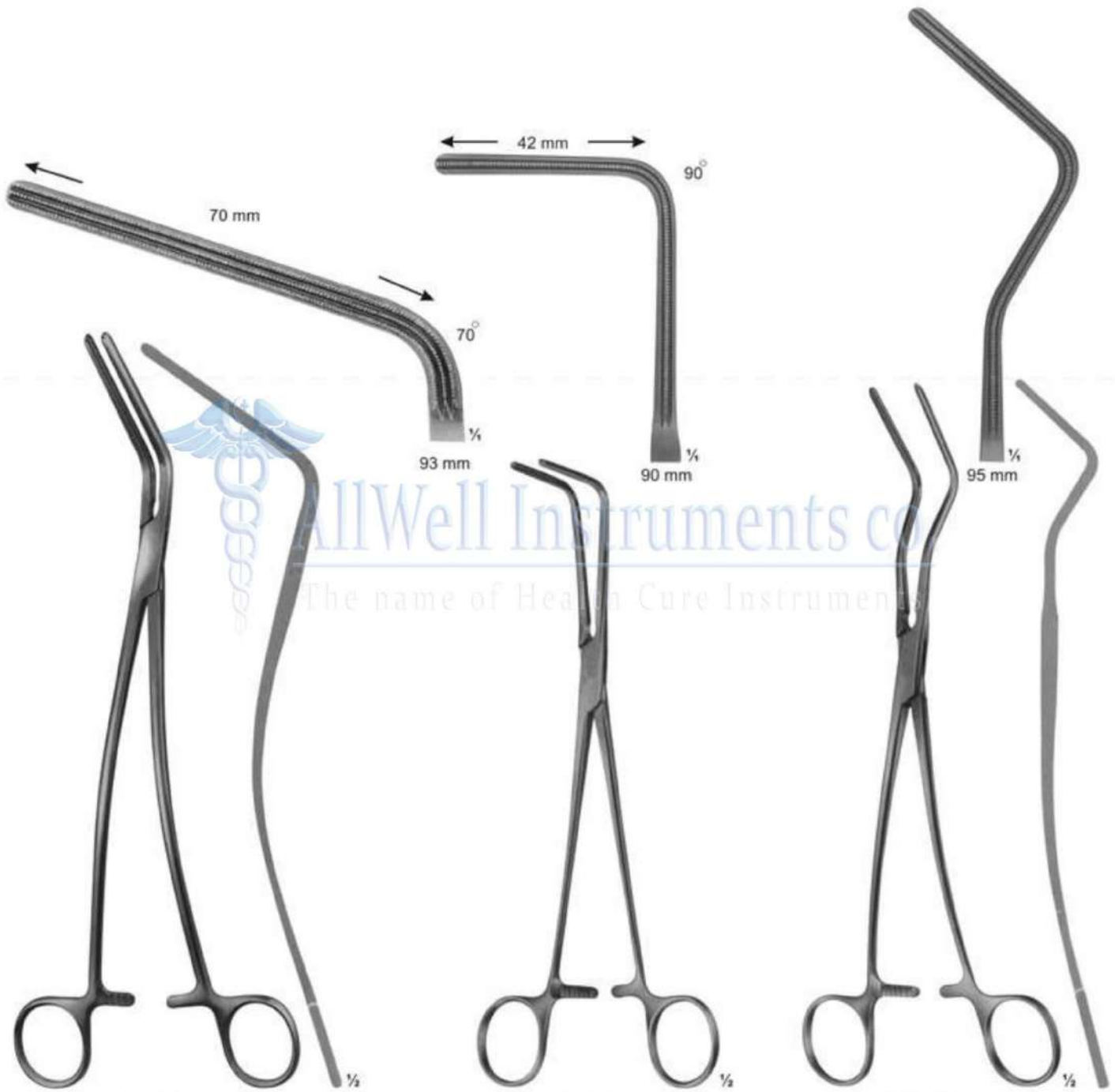

**05-7208**  
DE BAKEY (Morris Modif)  
240 mm

**05-7209**  
LEES  
220 mm

**05-7210**  
LEES  
245 mm

# Atraumata Aorta-Aneurysm Clamps

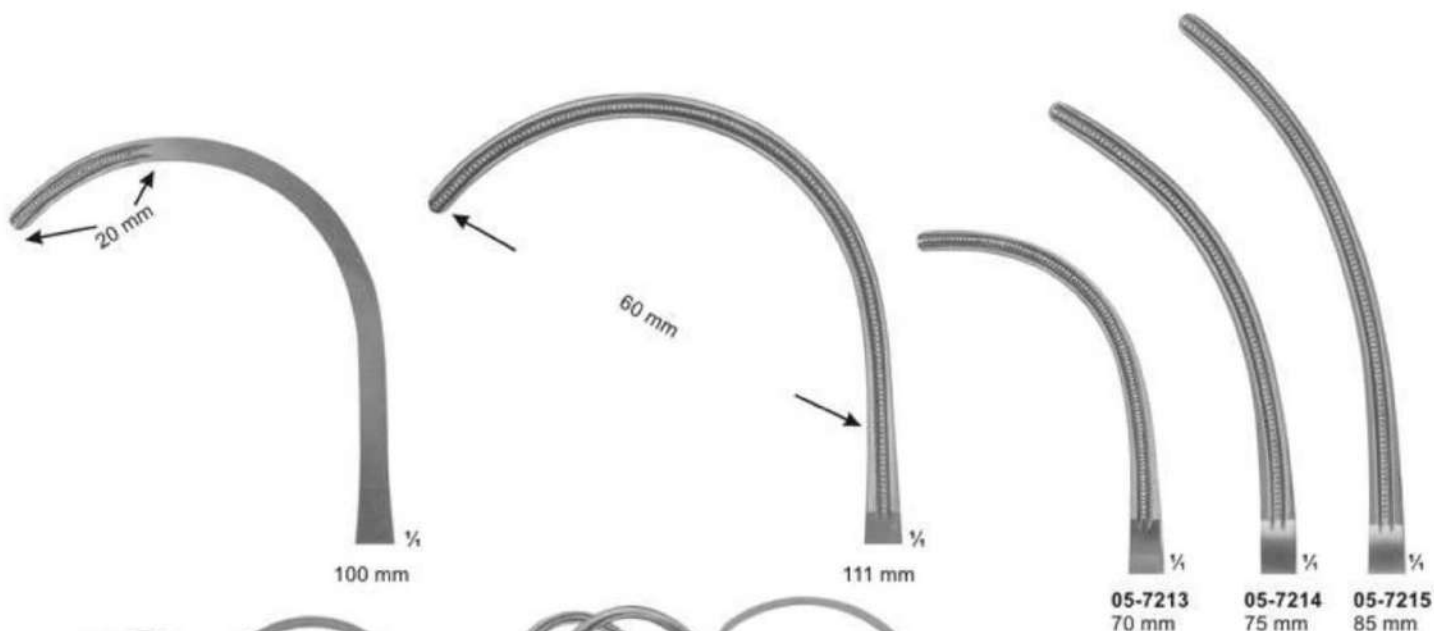

# Atraumata Aorta-Aneurysm Clamps

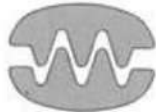

2.3 Teeth Rows

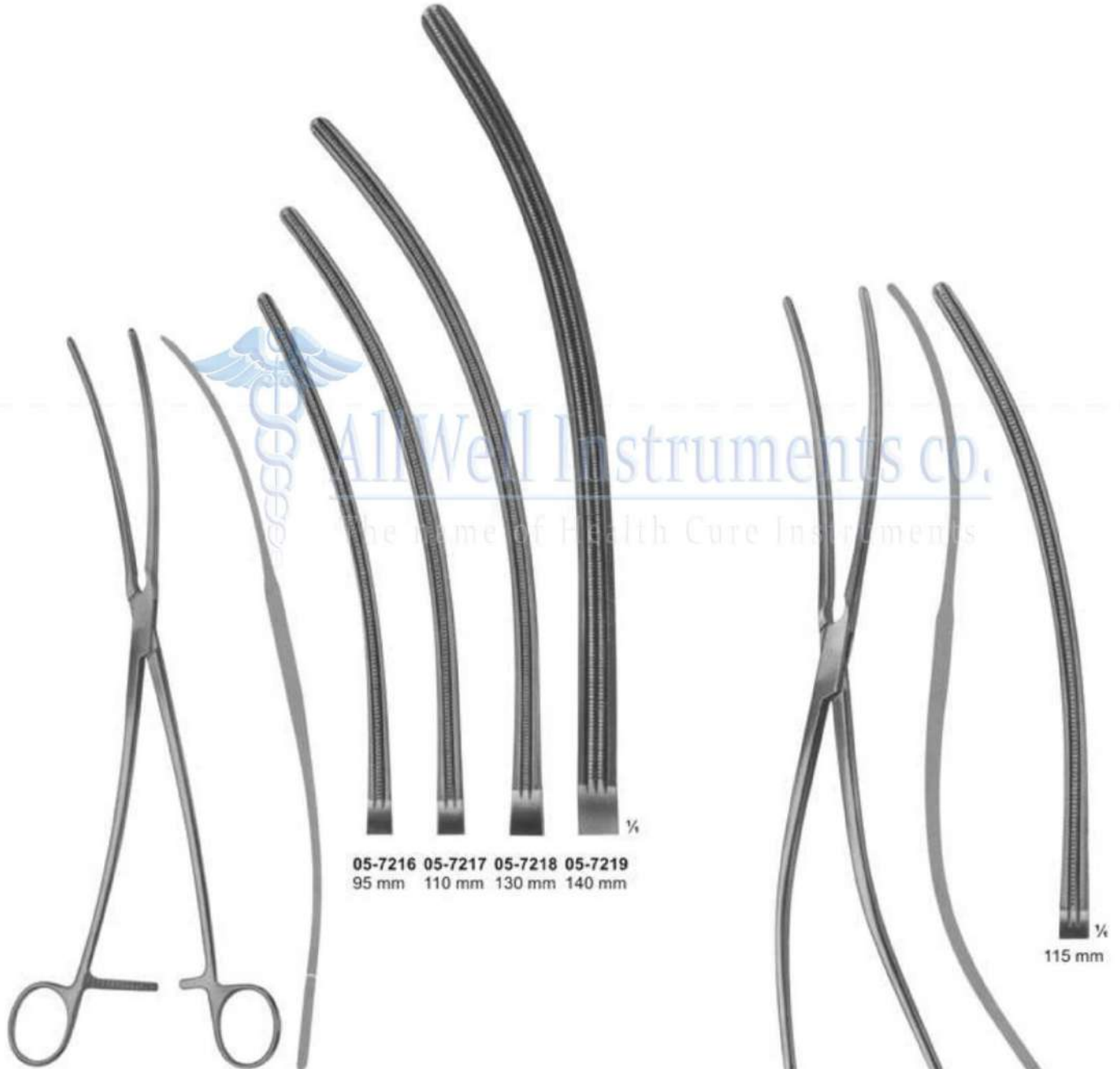

05-7216 05-7217 05-7218 05-7219  
95 mm 110 mm 130 mm 140 mm

115 mm

05-7216 - 05-7219  
DE BAKEY  
05-7216 250mm  
05-7217 300mm  
07-7218 315mm  
07-7219 330mm

05-7220  
DE BAKEY  
300 mm



# Atraumata Aorta Clamps

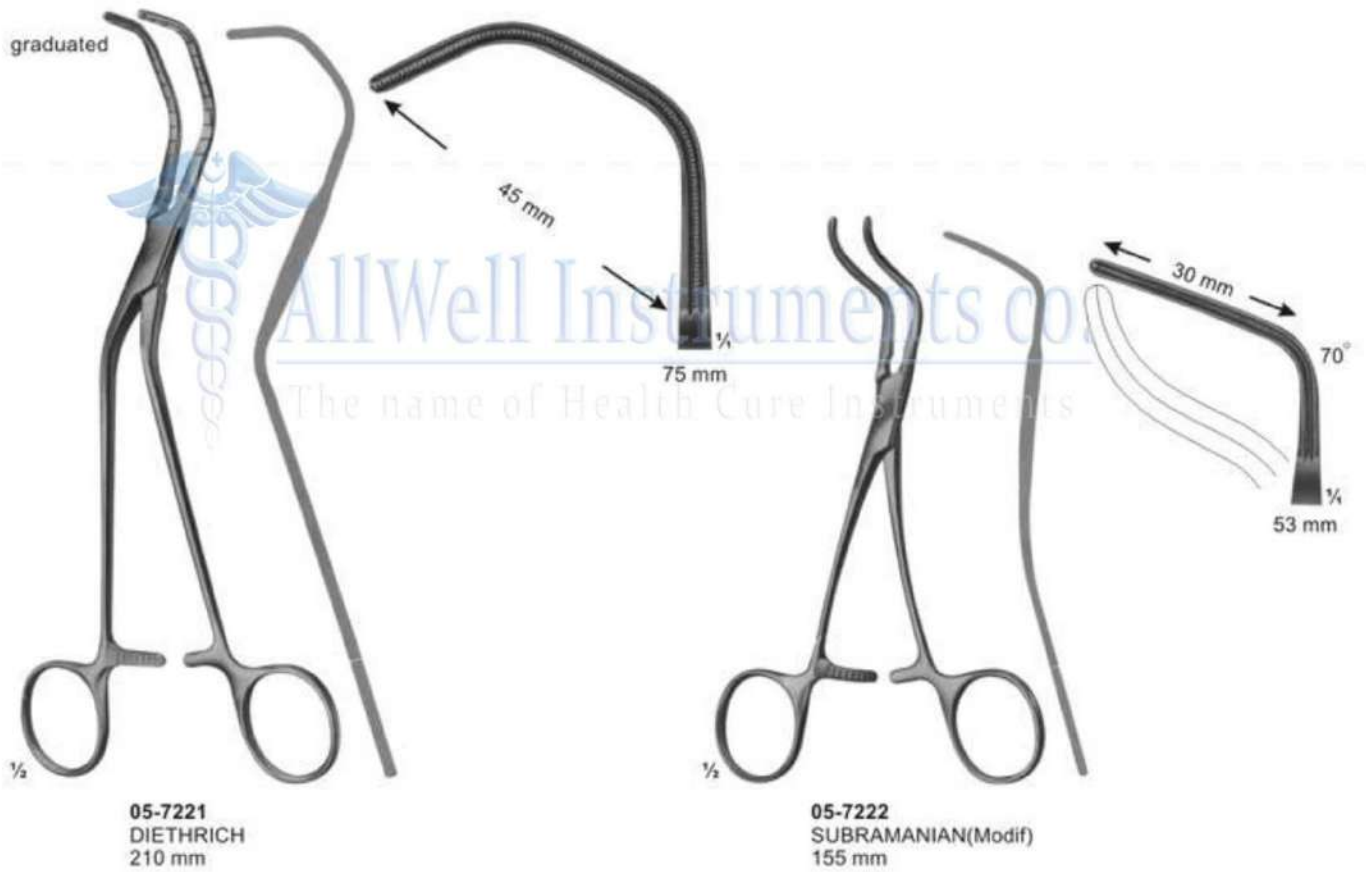

# Atraumata Aorta Clamps

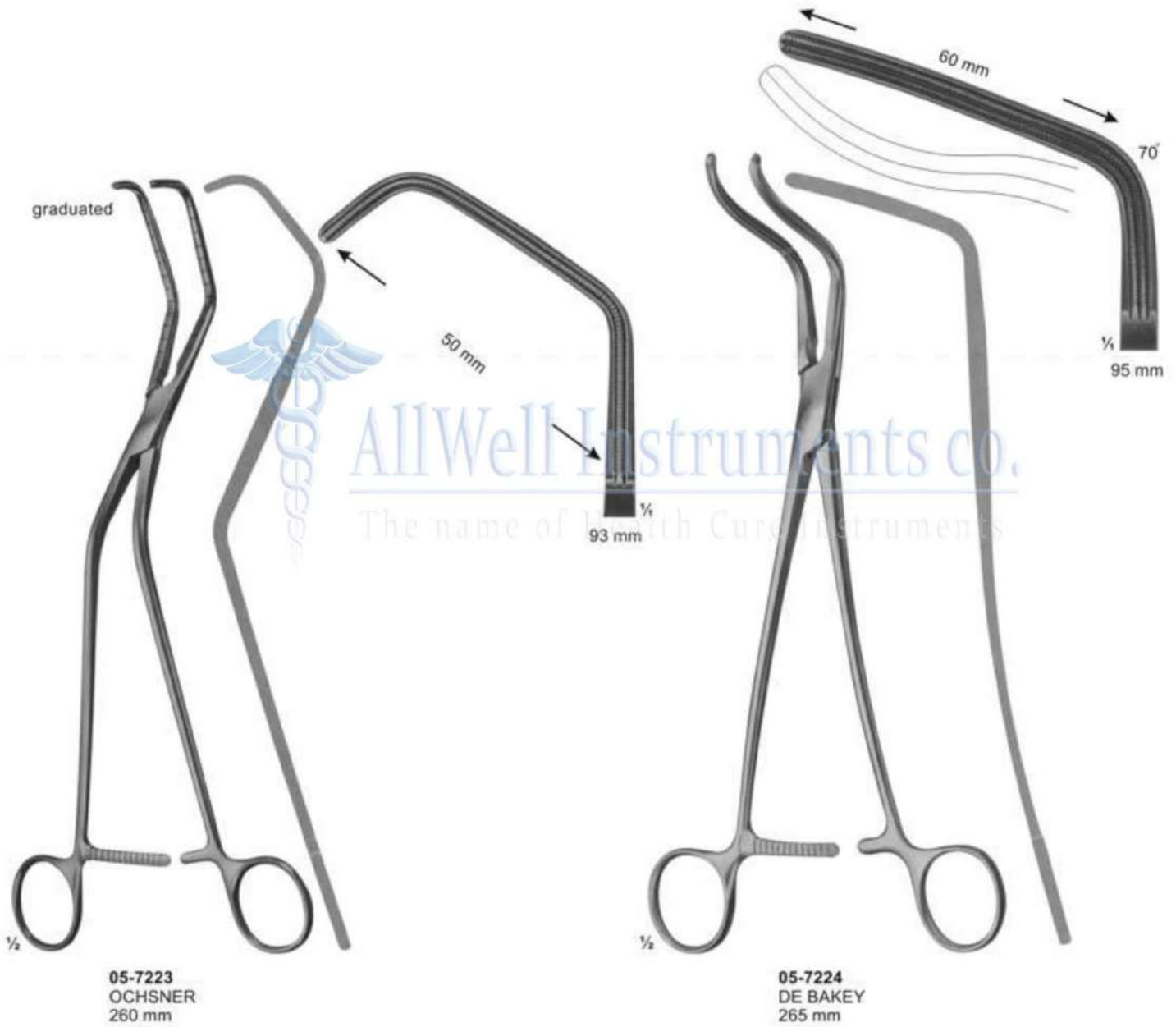

## Atraumata Aorta-Anastomosis Clamps

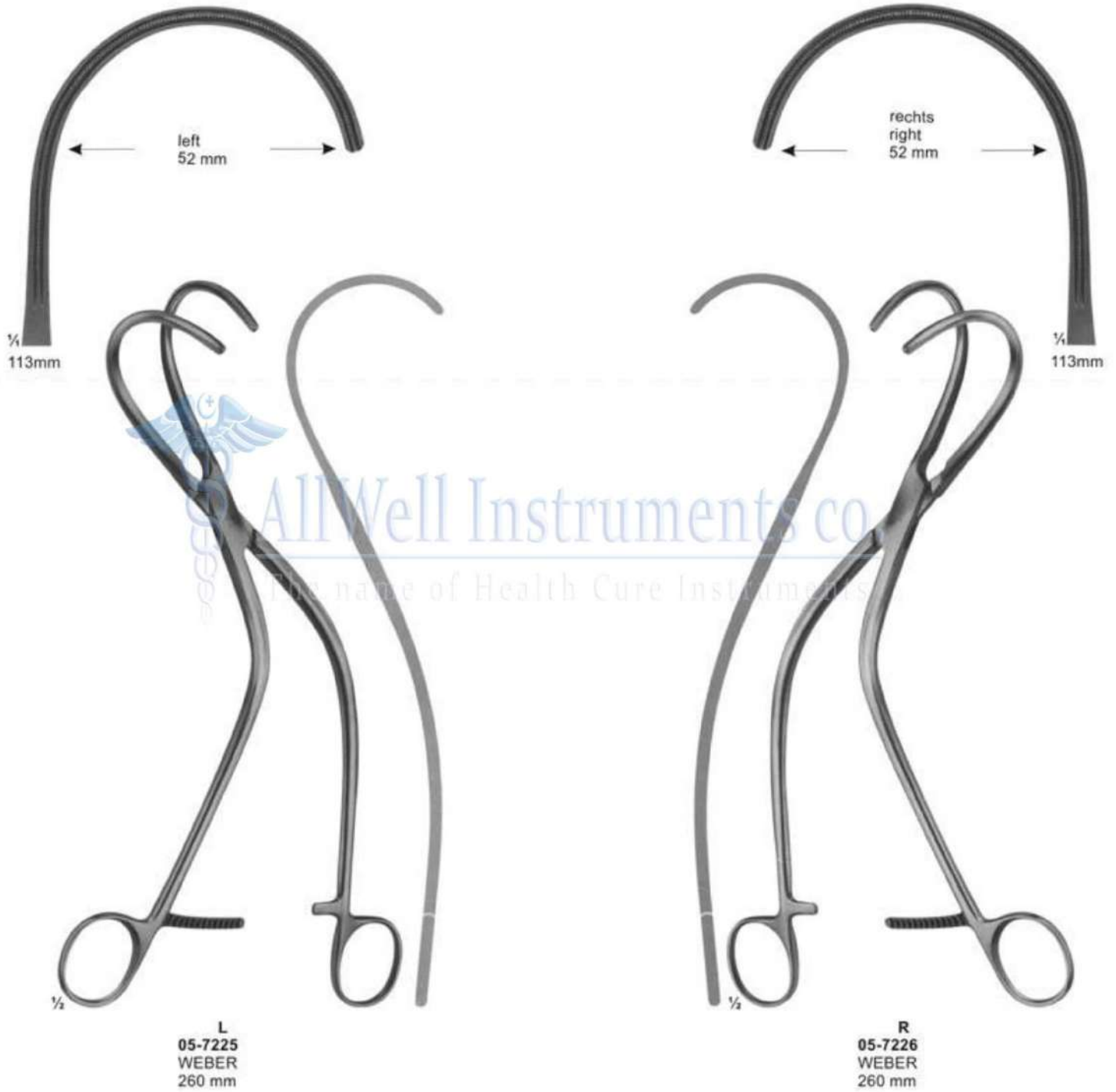



## Multi-Purpose Clamps



1/2  
05-7227 - 05-7230  
DE BAKAY

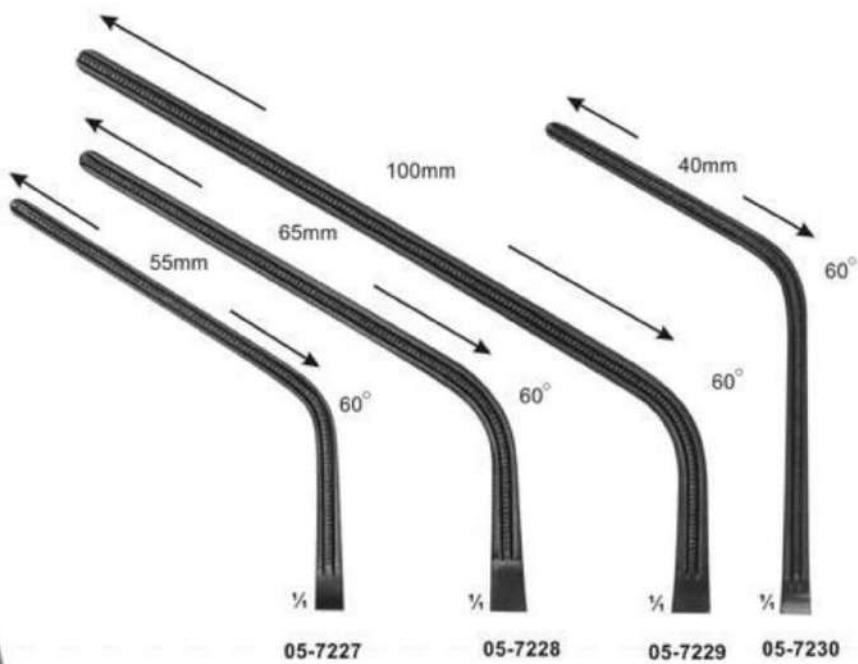

Total Length:	230 mm	280 mm	305 mm	240 mm
Length of jaws:	85 mm	100 mm	135 mm	93 mm



1/2  
05-7231 - 05-7234  
DE BAKAY

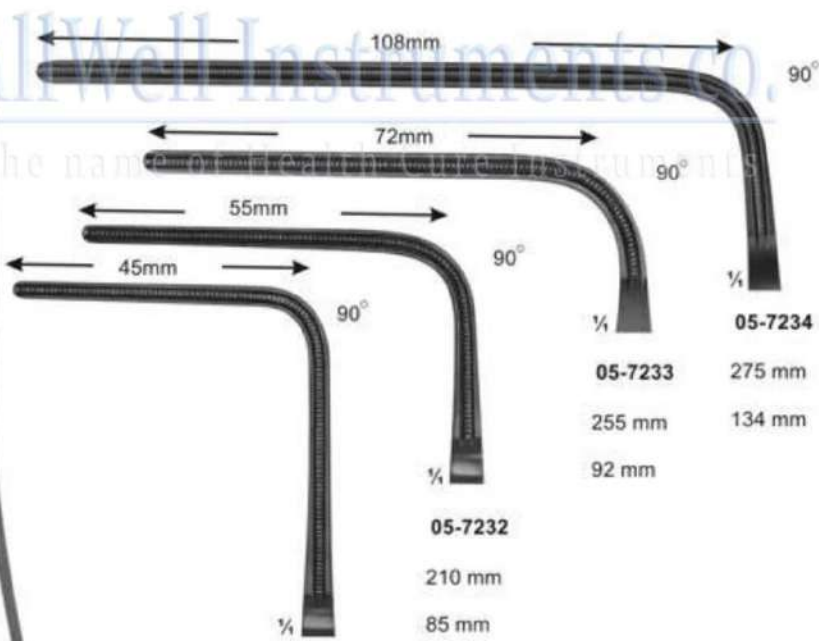

Total Length:	225 mm
Length of jaws:	93 mm

# Ring Handle Bulldog Clamps Anastomosis Clamps, Pediatric Types



05-7235  
50mm



05-7236  
50mm

05-7235 - 05-7236  
COOLEY  
125 mm, 115 mm



05-7237  
COOLEY  
100 mm

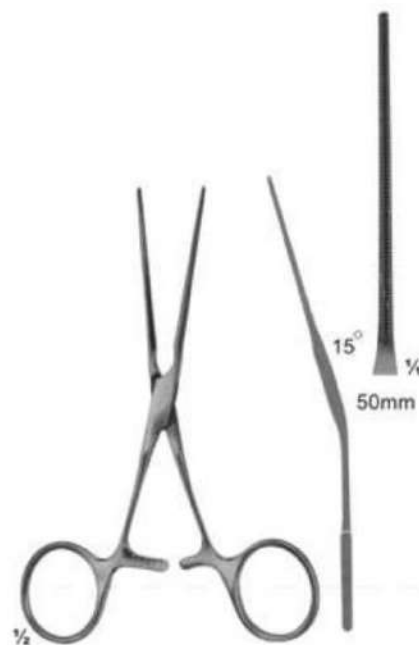

05-7238  
COOLEY  
125 mm

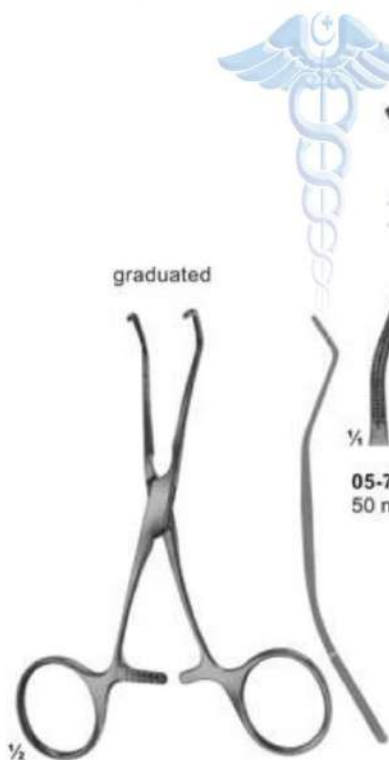

05-7239 - 05-7240  
COOLEY  
120 mm, 115 mm

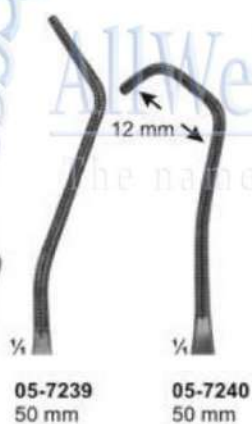

05-7239  
50 mm



05-7240  
50 mm

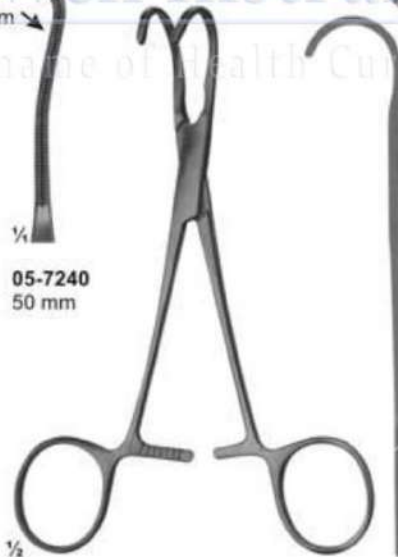

05-7241 - 05-7242  
COOLEY-BECK  
150 mm, 155 mm

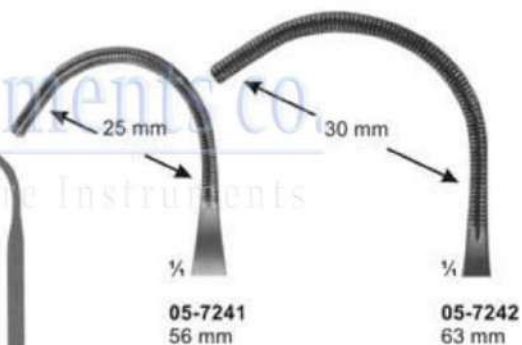

05-7242  
63 mm

## Anastomosis Clamps, Pediatric Types

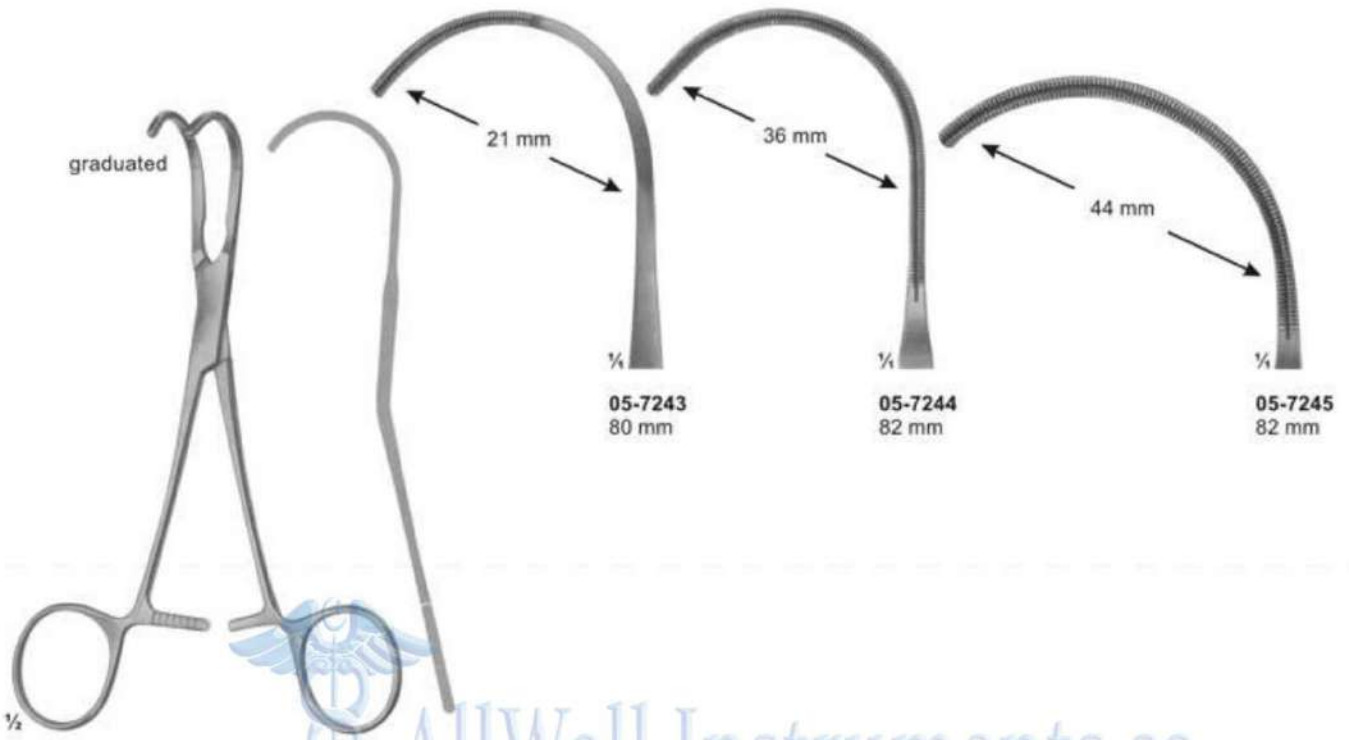

**05-7243 - 05-7245**  
**COOLEY**  
170 mm

**05-7243**  
80 mm

**05-7244**  
82 mm

**05-7245**  
82 mm

**AllWell Instruments co.**

The name of Health Cure Instruments

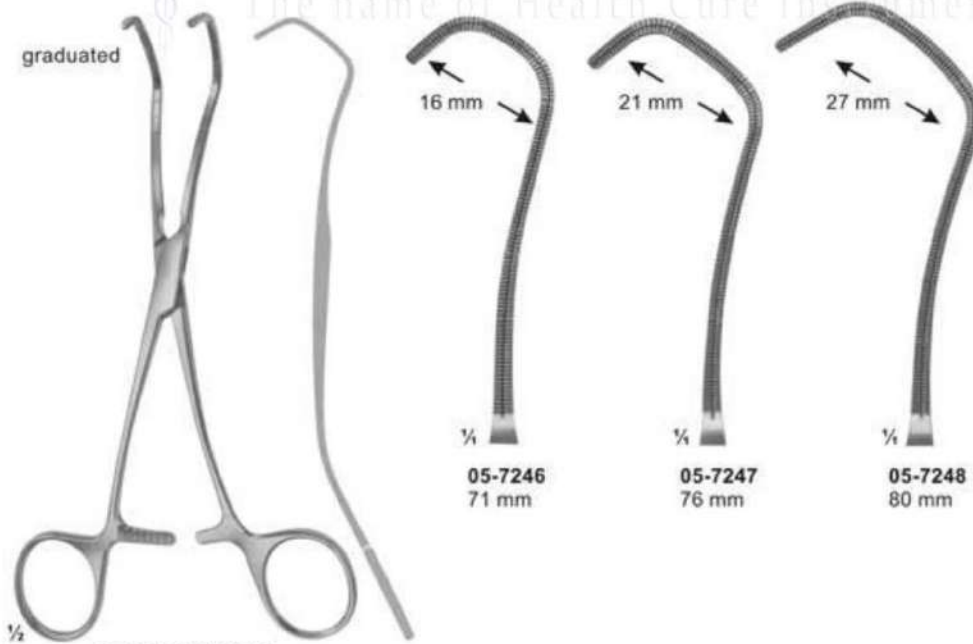

**05-7246 - 05-7248**  
**DERRA-COOLEY**  
**05-7246** 170mm  
**05-7247** 175mm  
**05-7248** 175mm

**05-7246**  
71 mm

**05-7247**  
76 mm

**05-7248**  
80 mm



# Anastomosis Clamps Multi-Purpose Clamps Pediatric Types



05-7249 - 05-7252  
COOLEY  
05-7249 165mm  
05-7250 165mm  
05-7251 175mm  
05-7252 180mm

AllWell Instruments co.

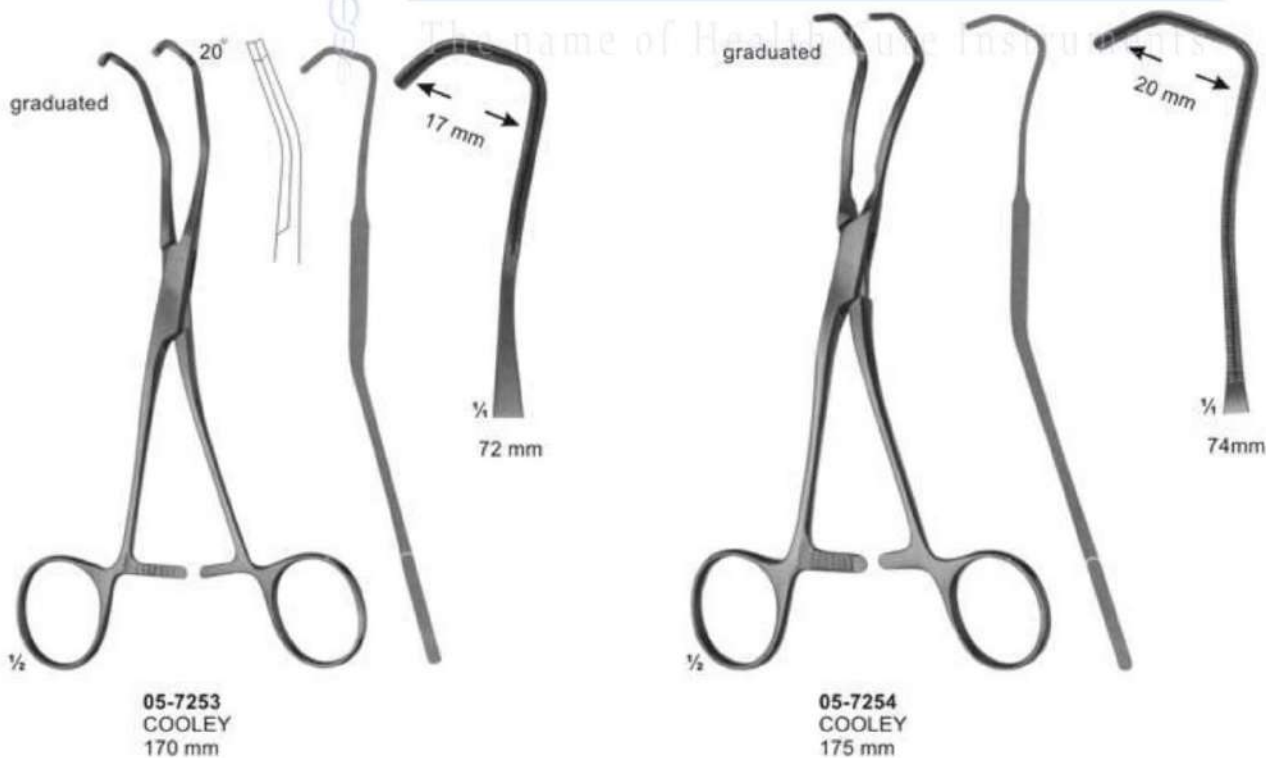

## Multi-Purpose Clamps, Pediatric Types

graduated

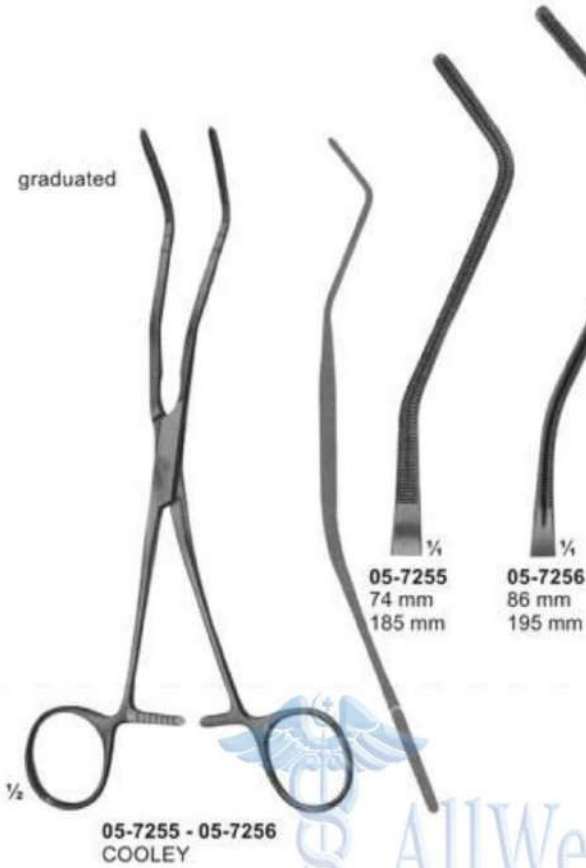

graduated



graduated

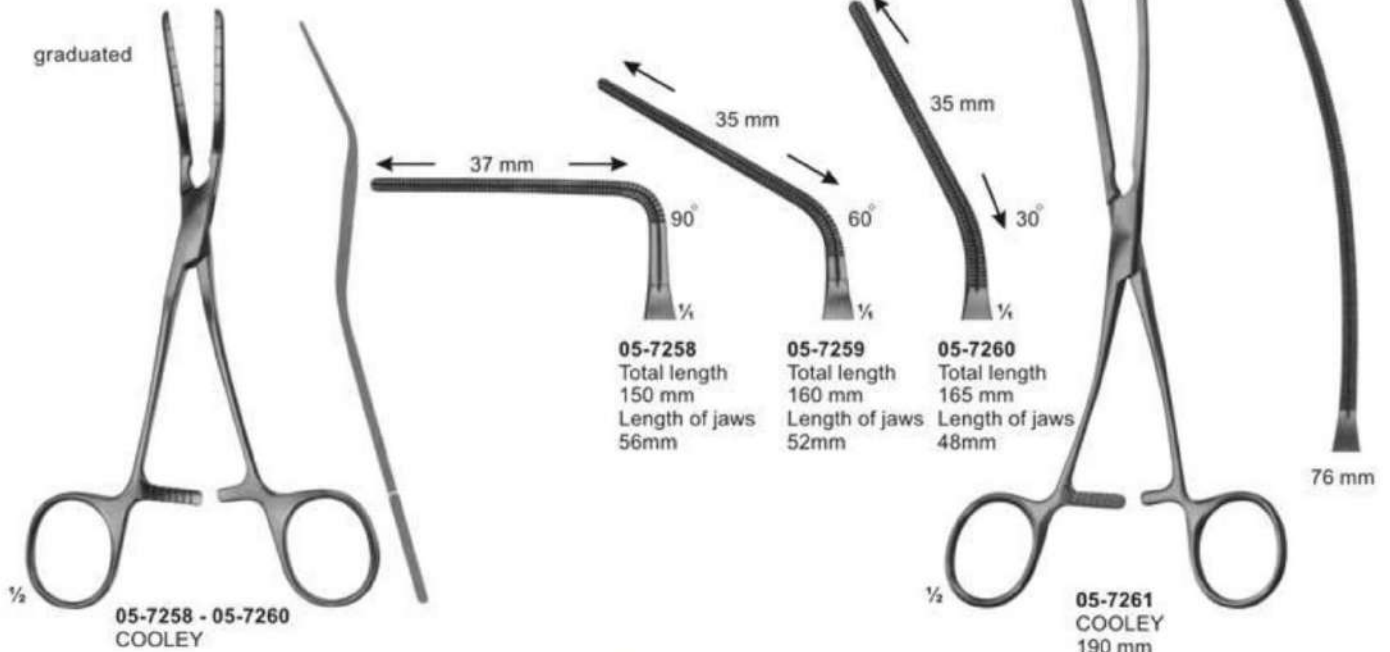

# Atraumata Aorta Clamps, Patent-Ductus Clamps, Coarctation Clamps Pediatric Types

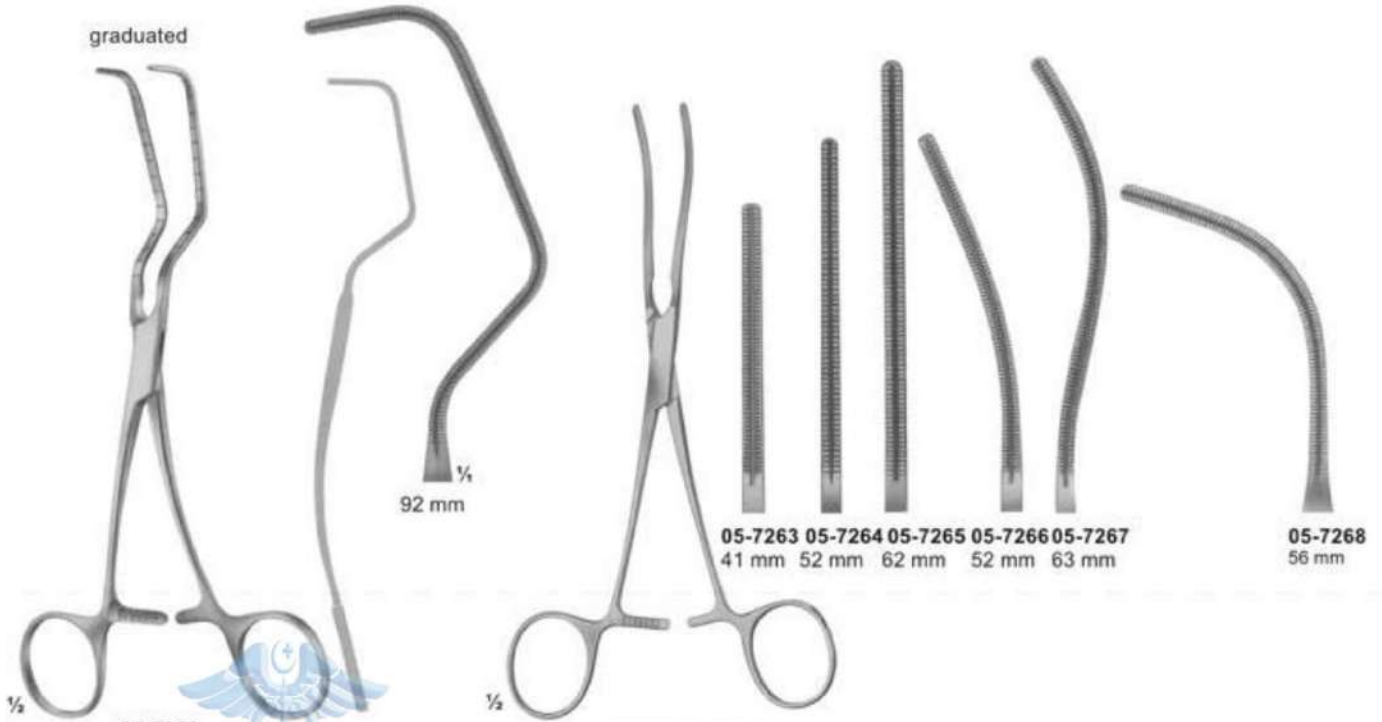

05-7262  
PARRY-COOLEY  
185 mm

05-7263 - 05-7268  
COOLEY

05-7263	160mm
05-7264	170mm
05-7265	180mm
05-7266	180mm
05-7267	180mm
05-7268	160mm

AllWell Instruments co.  
The name of Health Cure Instruments

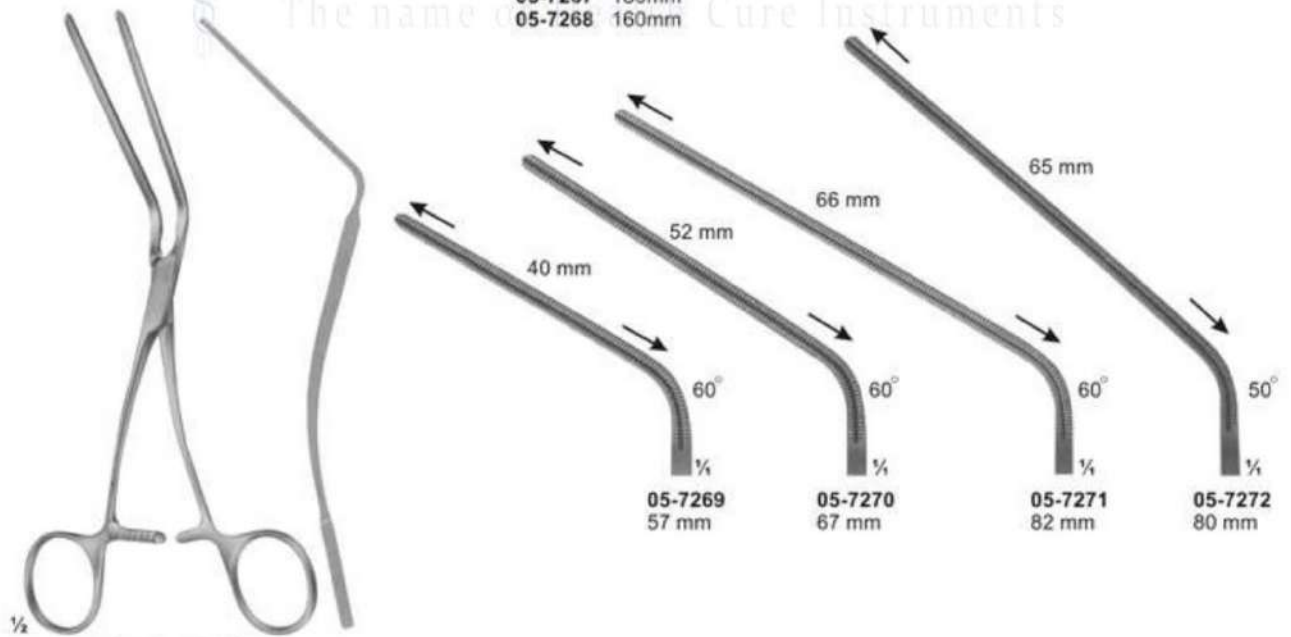

05-7269 - 05-7272

05-7269	165mm
05-7270	170mm
05-7271	185mm
05-7272	185mm



# Multi-Purpose Clamps



**05-7273 - 05-7282**

DARDIK

<b>05-7273</b>	150 mm	<b>05-7278</b>	170 mm
<b>05-7274</b>	150 mm	<b>05-7279</b>	170 mm
<b>05-7275</b>	150 mm	<b>05-7280</b>	170 mm
<b>05-7276</b>	145 mm	<b>05-7281</b>	160 mm
<b>05-7277</b>	130 mm	<b>05-7282</b>	135 mm

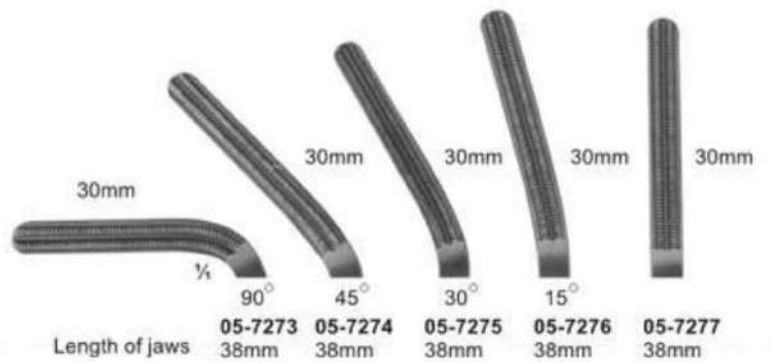

# Lung Grasping Forceps



**05-7283**  
**WILLIAMS**  
160 mm



**05-7284**  
**TUTTLE**  
230 mm



**05-7285**  
**NELSON**  
230 mm



**05-7286**  
**DUVAL**  
230 mm

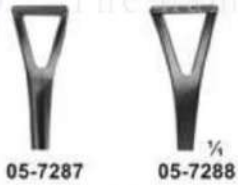

**05-7287**

**05-7288**



**05-7289**



**05-7287 - 05-7289**  
**BABCOCK**  
05-7287 170 mm  
05-7288 215 mm  
05-7289 220 mm



**05-7290**  
**ALLIS**  
220 mm

## Dissecting And Ligature Forceps



05-7291  
FINOCHIETTO  
245 mm



05-7292 - 05-7293  
SEMB  
240 mm



05-7293



05-7294  
WIKSTROEM  
205 mm



# Dissecting And Ligature Forceps, Vessel Clamps



**05-7295**  
MIXTER  
230 mm



**05-7296** 220 mm  
**05-7297** 250 mm

**05-7296 - 05-7297**  
MIXTER

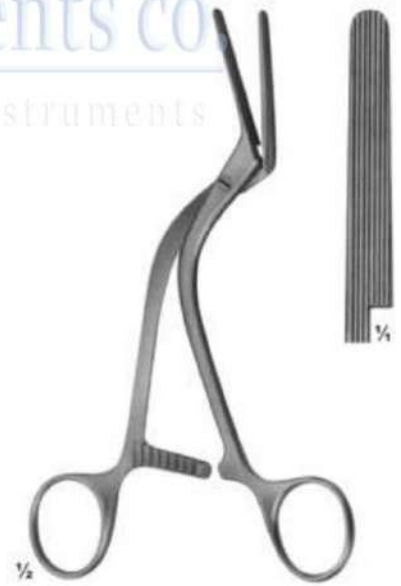

**05-7298**  
HOEPFNER  
Vessel clamp  
160 mm

# Vena Cava Clamps



## Carotid Clamps, Auricle Clamps



**05-7303**  
**PERTUISET**  
 Carotid Clamp  
 90 mm



**05-7304**  
**CRAFOORD-SELLORS**  
 240 mm



**05-7305 - 05-7306**  
**CRAFOORD**  
 240 mm



## Bronchus Forceps



**05-7307**  
PRICE THOMAS  
225 mm



**05-7308**  
jaws with pins

**05-7309**  
jaws with pins



**05-7308 - 05-7309**  
PRICE THOMAS  
225 mm

## Sternum Instruments And Rib Shears



**05-7310**  
**SCHUMACHER**  
Sternum shears  
210 mm



**05-7311**  
**LEBSCHE**  
Sternum chisel  
200 mm



**05-7312**  
230 mm



**05-7313**  
**COLLIN**  
195 mm



**05-7314**  
**GLUCK**  
190 mm



**05-7315**  
**BETHUNE**  
340 mm



**05-7316**  
**BRUNNER**  
Universal Pattern  
340 mm



**05-7317**  
**GIERTZ-STILLE**  
250 mm

# Rib Holding Forceps, Bone Cutting Forceps, Rib Rongeurs

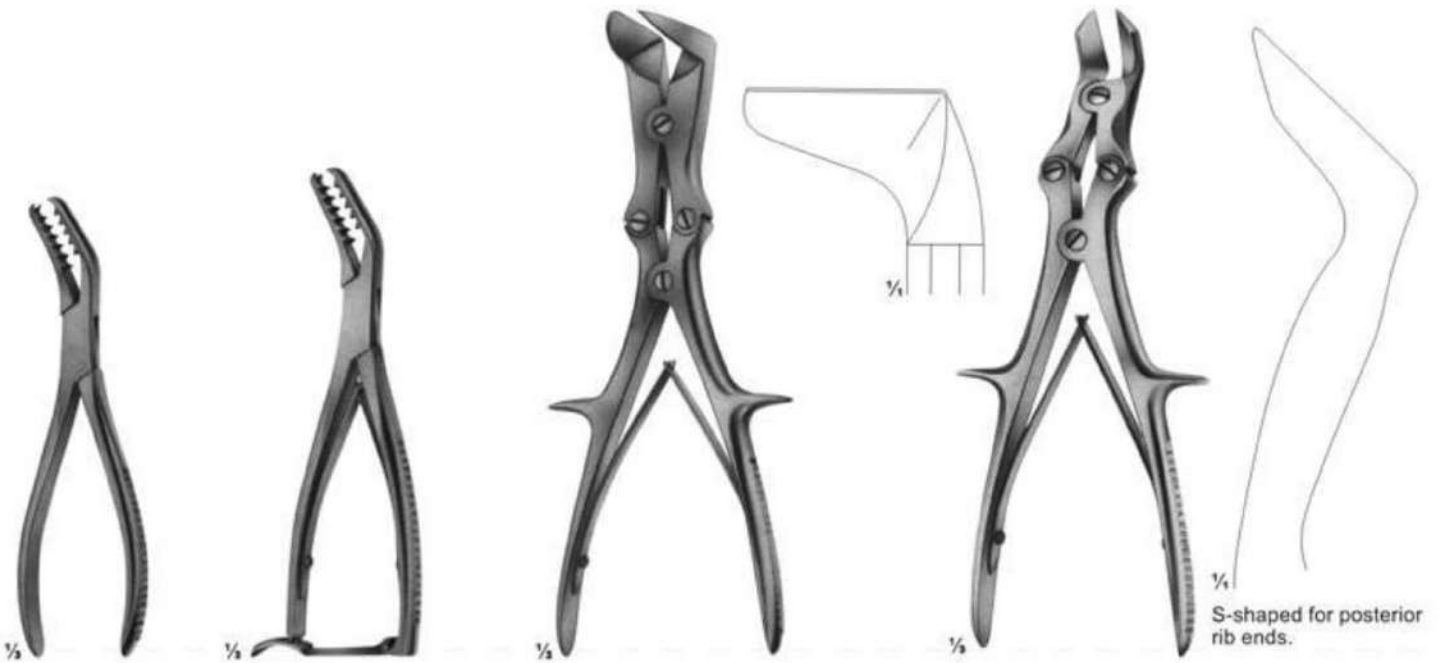

**05-7318**  
SEMB  
Rib-and Bone  
Holding forceps  
190 mm

**05-7319**  
SEMB  
Rib-and Bone  
Holding forceps  
190 mm

**05-7320**  
LISTON-STILLE  
265 mm

**05-7321**  
LISTON-KEY-HORSLEY  
(Tudor Edwards)  
255 mm

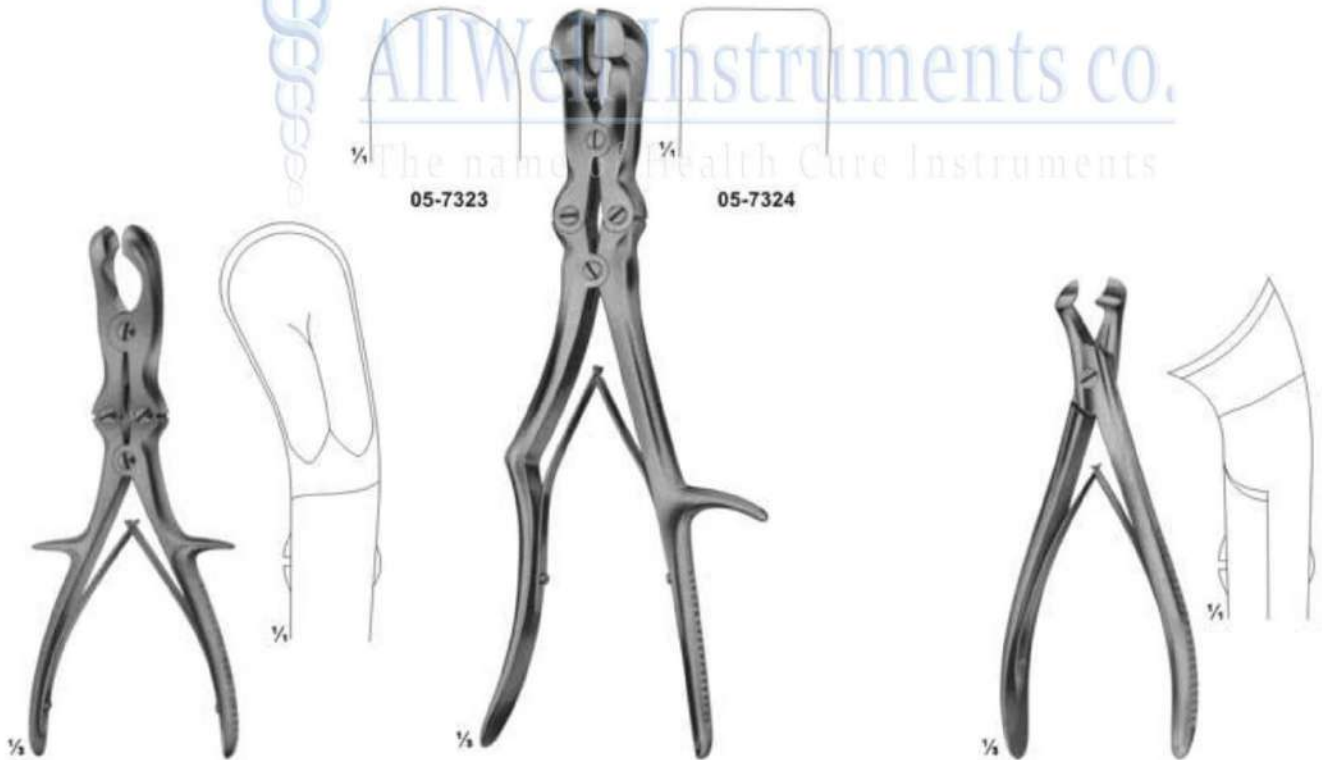

**05-7322**  
SEMB  
Rib Rongeur to shorten  
the rib stumps  
240 mm

**05-7323 - 05-7324**  
SAUERBRUCH-CORYLLOS  
Rib rongeurs to shorten  
the rib stumps  
310 mm

**05-7325**  
MARKWALDER  
Rib Rongeur to Round  
the rib stumps  
190 mm



# Rib Raspatories



**05-7326 - 05-7327**  
DOYEN  
for children  
175 mm

**05-7328 - 05-7329**  
DOYEN  
for adults  
175 mm

**05-7330 - 05-7331**  
DOYEN  
240 mm

# Rib Raspatories

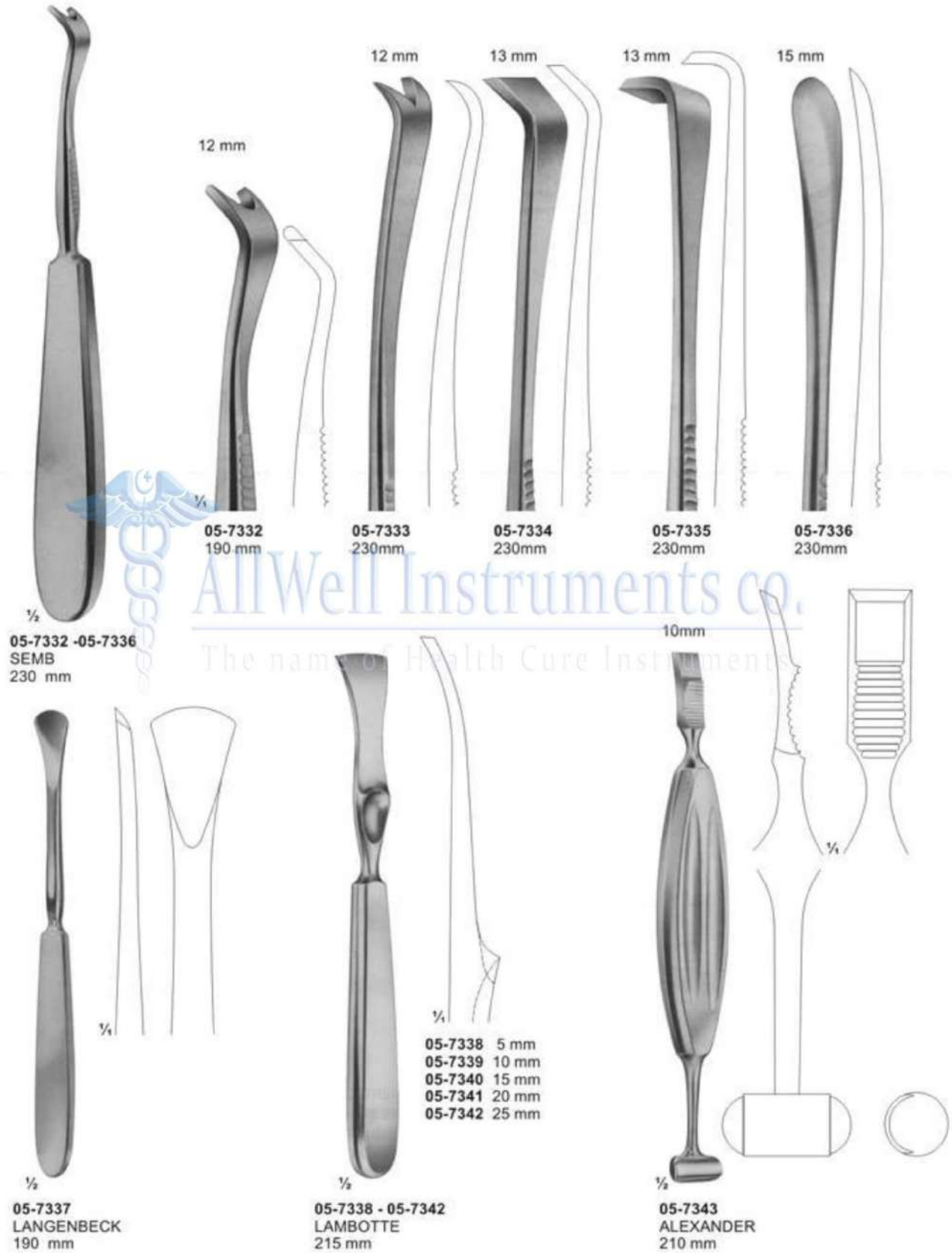

# Rib Spreaders



**05-7344**  
**FINOCHIETTO**  
Blades  
18X21 mm



**05-7345**  
**HERTZLER**  
Blades  
20X25 mm

**AllWell Instruments co.**

The name of Health Care Instruments

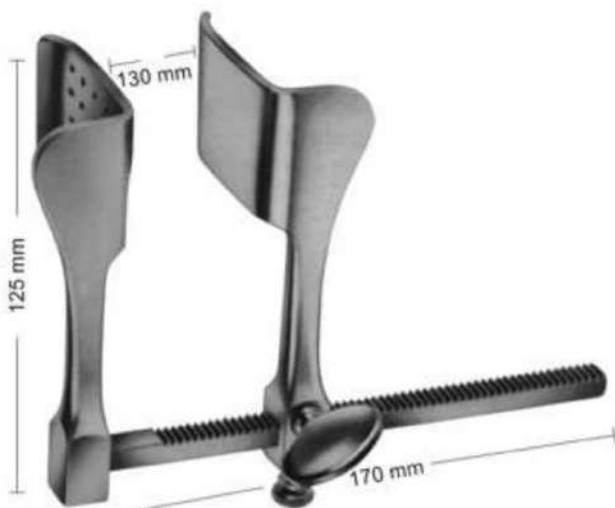

**05-7346**  
**TUFFIER**  
Blades  
43X53 mm

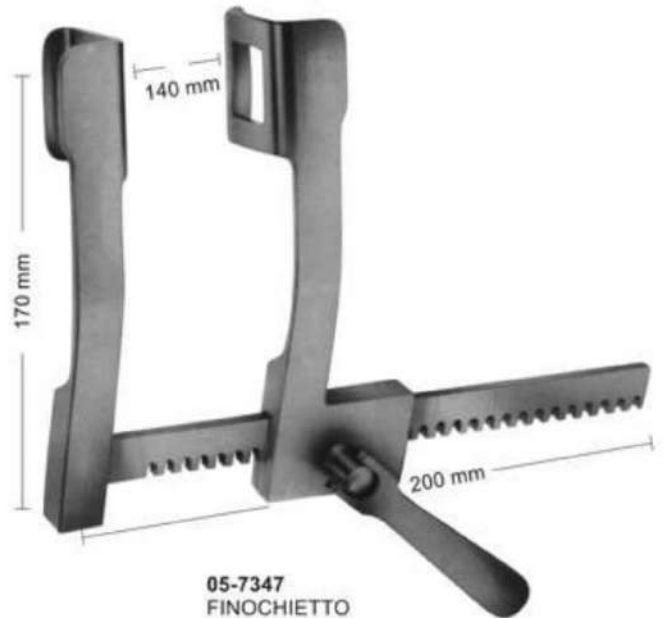

**05-7347**  
**FINOCHIETTO**  
Blades  
36X45 mm



## Rib Spreaders



05-7348  
FINOCHIETTO  
Blades  
44X65 mm

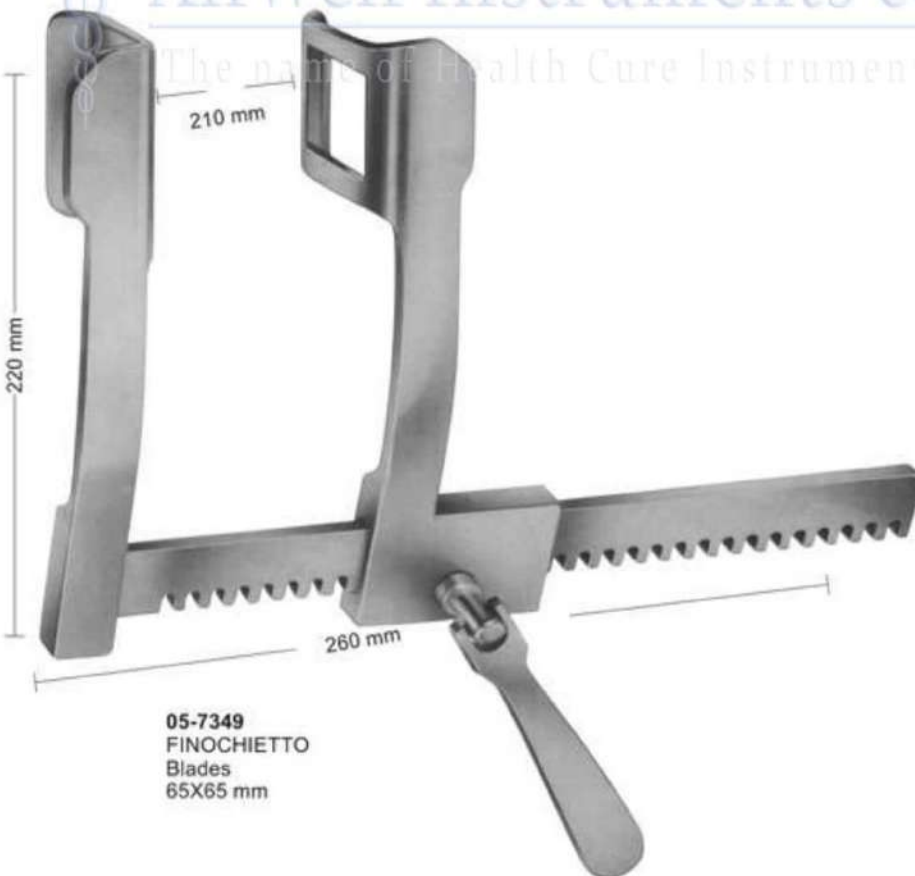

05-7349  
FINOCHIETTO  
Blades  
65X65 mm

# Rib Spreaders

**05-7351**  
 Blades  
 30x80 mm



**05-7352**  
 Blades  
 40x67 mm



**05-7353**  
 Blades  
 80x67 mm



AllWell Instruments co.  
 The name of Health Care Instruments

220 mm

220 mm

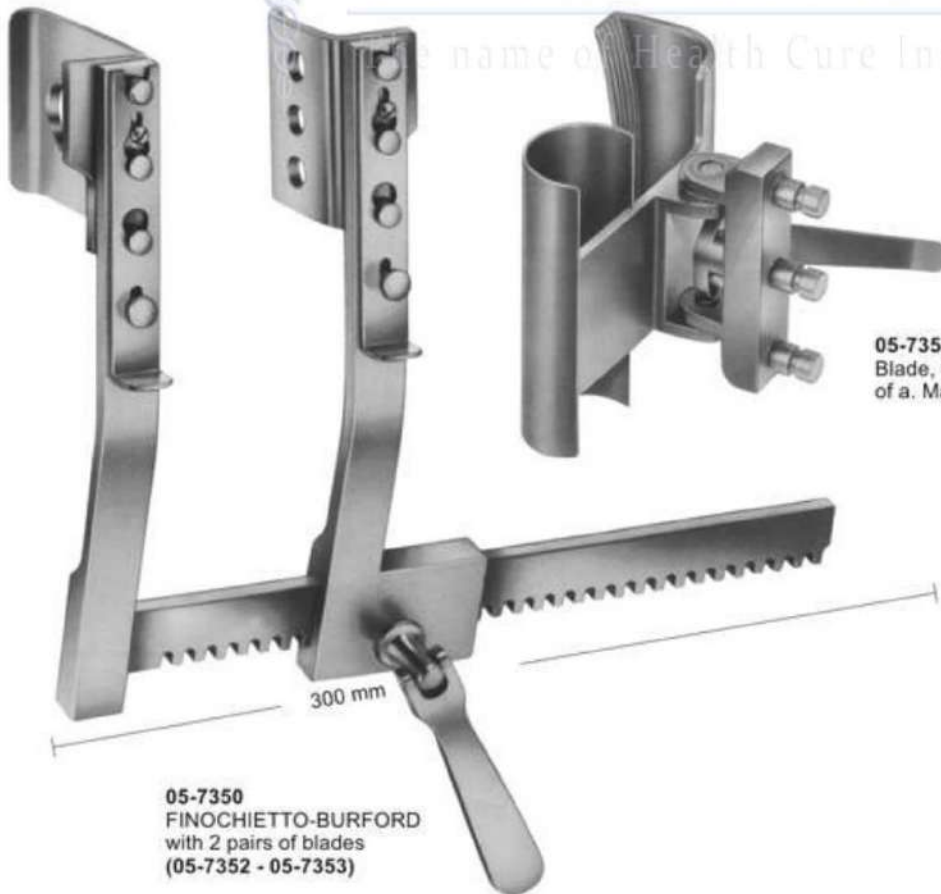

**05-7354**  
 Blade, Only, for preparation  
 of a. Mammaria, 25.5x80mm

**05-7350**  
**FINOCHIETTO-BURFORD**  
 with 2 pairs of blades  
 (05-7352 - 05-7353)

## Rib Spreaders

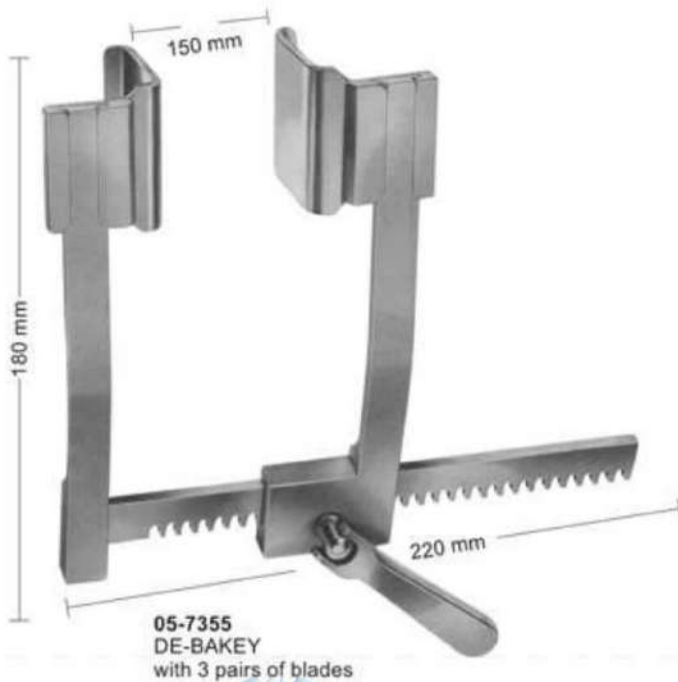

Components for **05-7355**  
Spreader only    Blades only  
**05-7357** 30x30mm  
**05-7358** 40x40mm  
**05-7359** 50x50mm  
The Blades are delivered in Pairs.

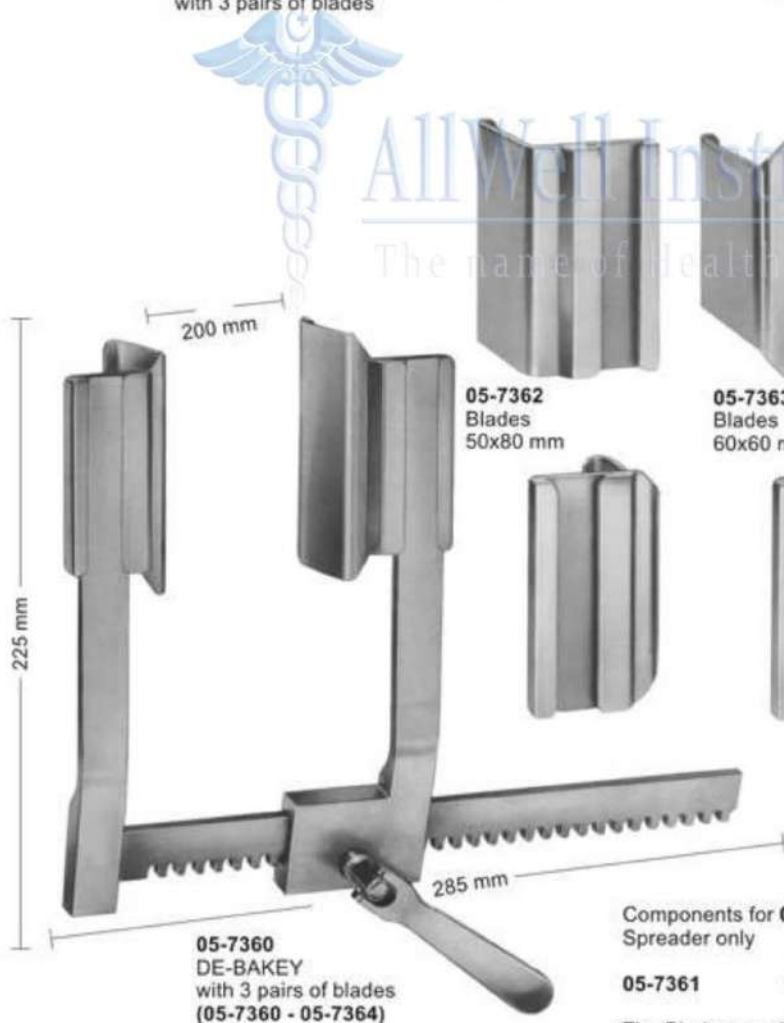

Components for **05-7360**  
Spreader only    Blades only  
**05-7362** 50x80mm  
**05-7363** 60x60mm  
**05-7364** 40x100mm  
**05-7366** Sternotomy Blades (50x66 mm)  
The Blades are delivered in Pairs.



## Sternotomy Spreaders

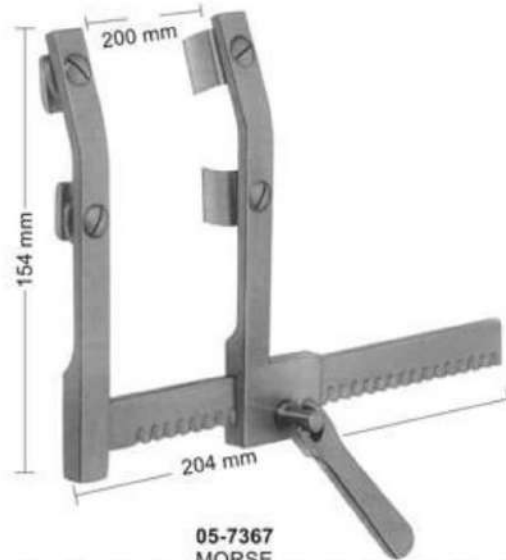

**05-7367**  
**MORSE**  
Sternotomy spreader  
for children, with moveable  
double, blades each blade  
12x20 mm



AllWell Instruments co.

The name of Health Care Instruments



**05-7368**  
**MORSE**  
Sternotomy spreader  
for adults, with moveable  
double, blades each blade  
19x19 mm

## Sternotomy- Spreaders



**05-7369**  
COOLEY  
Blades  
for children  
21x45mm



**05-7370**  
COOLEY  
Blades  
for adults  
32x50mm

# Thoracic Retractors



**05-7371**  
Blades  
75x75 mm



**05-7373**  
Blades  
42x65 mm

Blades with Ball Snap System  
Delivery: in Pairs

- 05-7371 - 05-7373**  
Thoracic Retractor (Mercedes-Retractor)  
complete consisting of:  
**05-7371** Retractor only  
**05-7372** 1 Pair of blades 75x75 mm  
**05-7373** 1 Pair of blades 42x65 mm



# Rib Spreaders-and Contractors



**05-7374**  
**SELLORS**  
Rib spreader-and contractor  
with swivel blades  
200 mm



**05-7375**  
**BAILEY**  
150 mm



**05-7376**  
for children

**05-7377**  
for adults

**05-7376 - 05-7377**  
**BAILEY**  
200 mm

## Retractors, Lung Spatulas

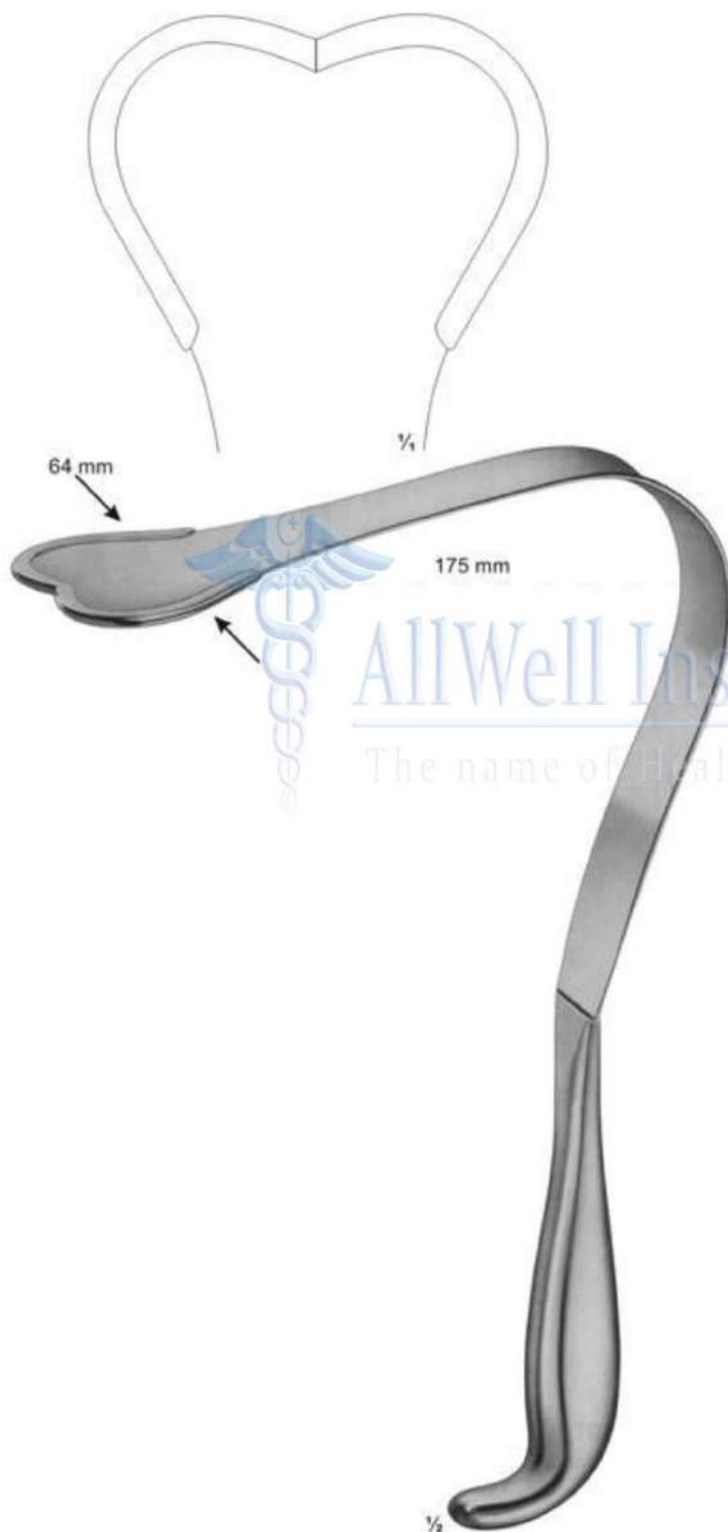

**05-7378**  
HARRINGTON-PEMBERTON  
flexible  
295 mm

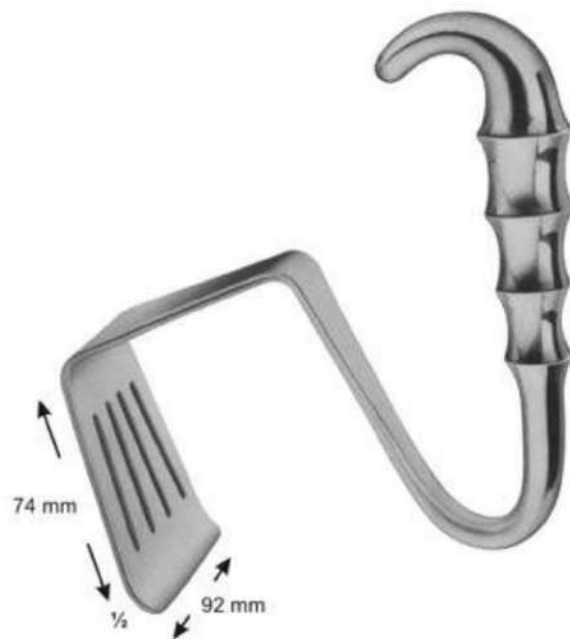

**05-7379**  
DAVIDSON  
Scapula retractor

## Lung Spatulas, Suction Cannulae

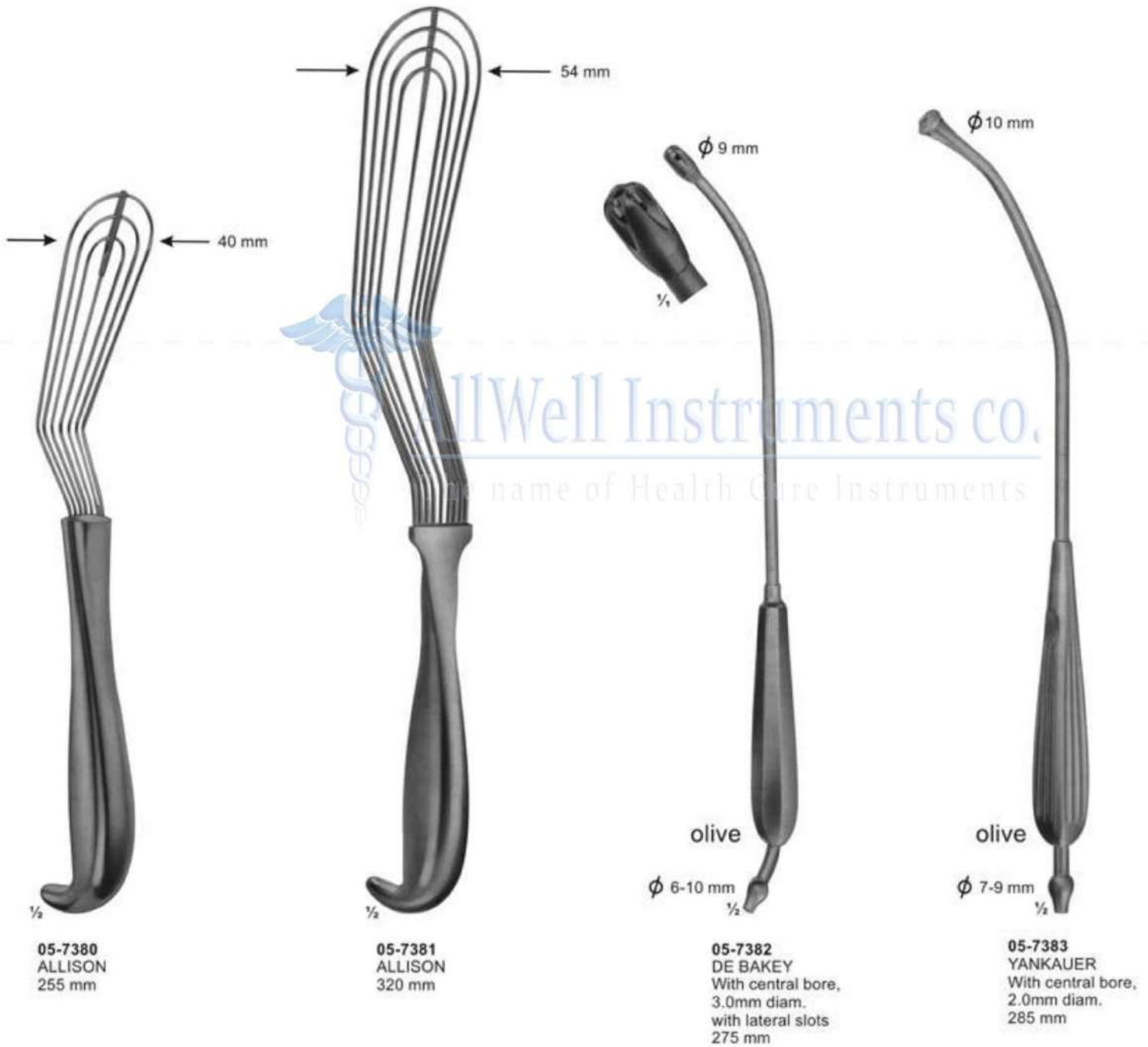



# Punches

Angled positions for punchus

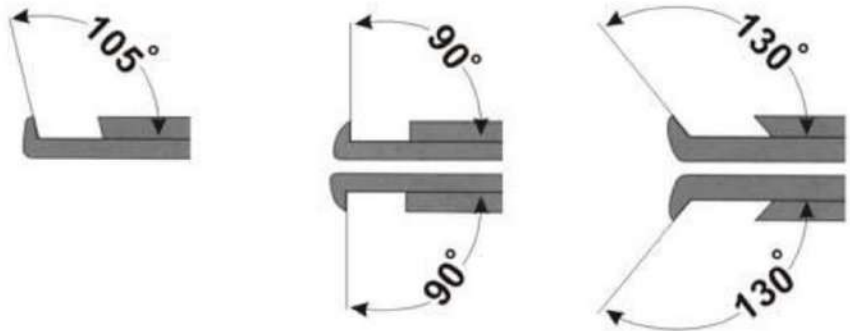

**05-7384 - 05-7385**  
CITELLI  
05-7384 2mm  
05-7385 3.5mm



**05-7386**  
CITELLI- BEYER  
1,8 mm

# Punches

**90°** upwards cutting

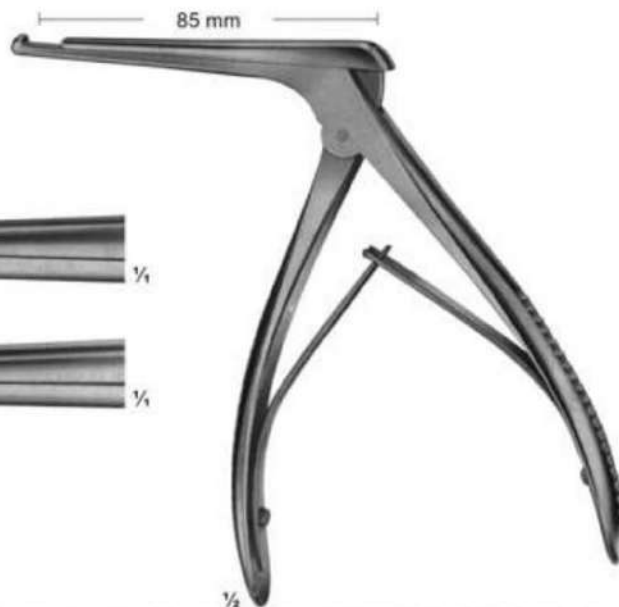

05-7387  
4 mm



¼

05-7388  
5 mm



¼

½

05-7387 - 05-7388  
KERRISON



**AllWell Instruments co.**

The name of Health Care Instruments

**90°** upwards cutting

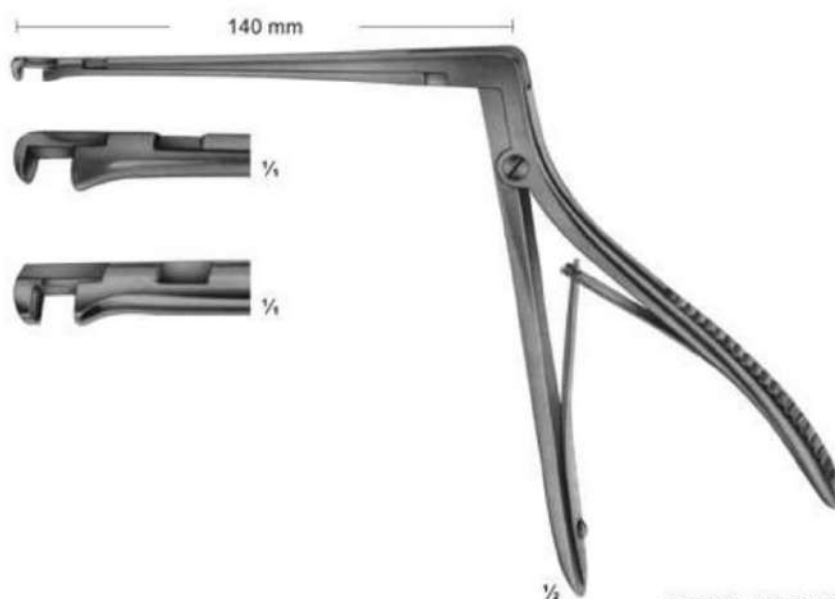

05-7389  
3,3 mm



¼

05-7390  
4,0 mm



¼

½

05-7389 - 05-7390  
HAJEK-KOFLER

# Punches

**130°** upwards cutting

KERRISON-JACOBY

05-7391  
1 mm 

FERRIS-SMITH-KERRISON

05-7392  
2 mm 

05-7393  
3 mm 

05-7394  
4 mm 

05-7395  
5 mm 

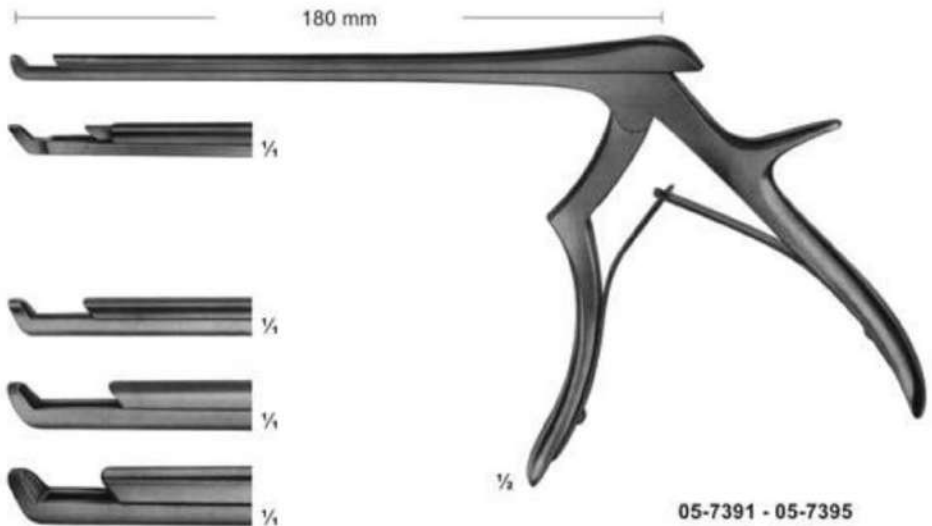

05-7391 - 05-7395

**AllWell Instruments co.**  
 The name of Health Cure Instruments

**90°** upwards cutting

KERRISON-JACOBY

05-7396  
1 mm 

05-7397  
2 mm 

FERRIS-SMITH-KERRISON

05-7398  
3 mm 

05-7399  
4 mm 

05-7400  
5 mm 

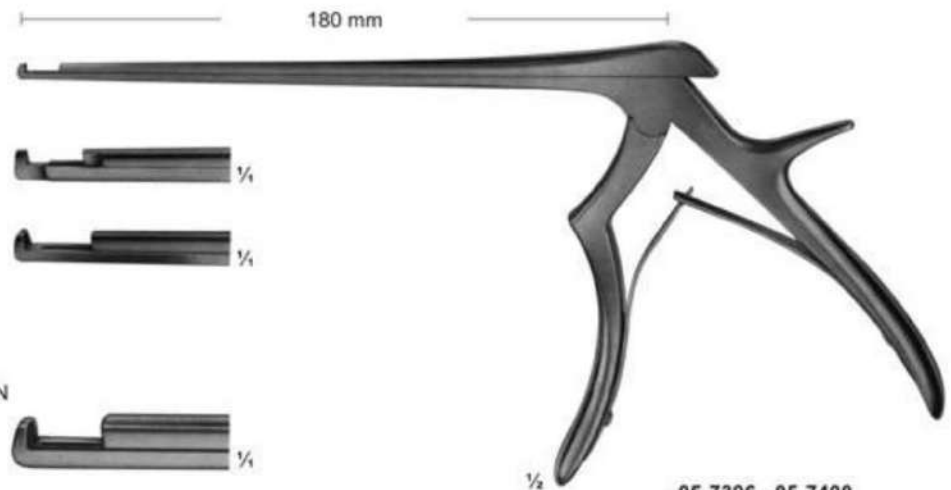

05-7396 - 05-7400



# Rongeurs

Angled positions for rongeurs

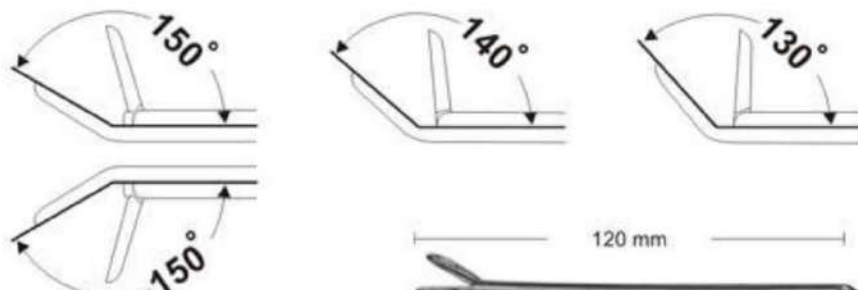

- 05-7401  
3,0 mm
- 05-7402  
3,6 mm
- 05-7403  
4,2 mm
- 05-7404  
4,8 mm
- 05-7405  
5,8 mm

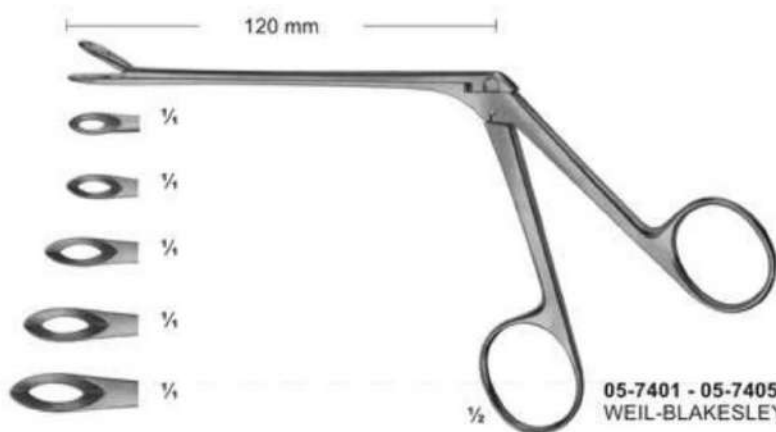

AllWell Instruments co.  
The name of Health Care Instruments



130°

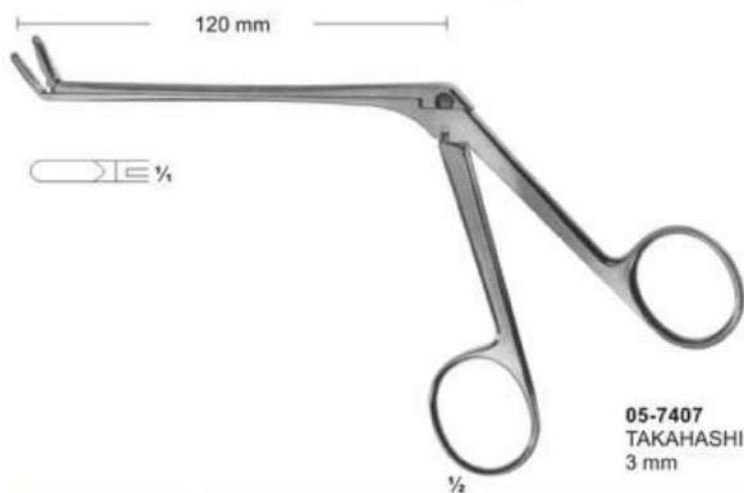

# Rongeurs

LOVE-GRUENWALD

05-7408  
2 X 10 mm



05-7409  
3 X 10 mm



SPURLING

05-7410  
4 X 10 mm



1/2 05-7408 - 05-7410



AllWell Instruments co.

The name of Health Care Instruments

05-7411  
2 mm



05-7412  
3 mm



05-7413  
4 mm



05-7414  
5 mm



1/2

05-7411 - 05-7414  
CASPAR

150°

05-7415  
2 mm



05-7416  
3 mm



05-7417  
4 mm



1/2

05-7415 - 05-7417  
CASPAR

# Rongeurs

**150°**

Lower part of jaws movable

**05-7418**  
2 mm

**05-7419**  
3 mm

**05-7420**  
4 mm



**05-7418 - 05-7420**  
CASPAR



**AllWell Instruments co.**

Length of shaft  
140 mm

Length of shaft  
160 mm

Length of shaft  
185 mm

size of jaws

**05-7421**

**05-7426**

**05-7431**

2 X 12 mm

1/4

**05-7422**

**05-7427**

**05-7432**

3 X 12 mm

1/4

**05-7423**

**05-7428**

**05-7433**

4 X 14 mm

1/4

**05-7424**

**05-7429**

**05-7434**

5 X 14 mm

1/4

**05-7425**

**05-7430**

**05-7435**

6 X 16 mm

1/4

1/2

**05-7421 - 05-7435**  
CASPAR

**150°**

Length of shaft  
140 mm

Length of shaft  
160 mm

Length of shaft  
185 mm

size of jaws

**05-7436**

**05-7439**

**05-7442**

3 X 12 mm

1/4

**05-7437**

**05-7440**

**05-7443**

4 X 14 mm

1/4

**05-7438**

**05-7441**

**05-7444**

5 X 14 mm

1/4

1/2

**05-7436 - 05-7444**  
CASPAR



# Rongeurs

**150°**

Lower part of jaw movable

Length of shaft 140 mm	Length of shaft 160 mm	Length of shaft 185 mm	size of jaws
<b>05-7445</b>	<b>05-7447</b>	<b>05-7449</b>	3 X12 mm
<b>05-7446</b>	<b>05-7448</b>	<b>05-7450</b>	4 X14 mm

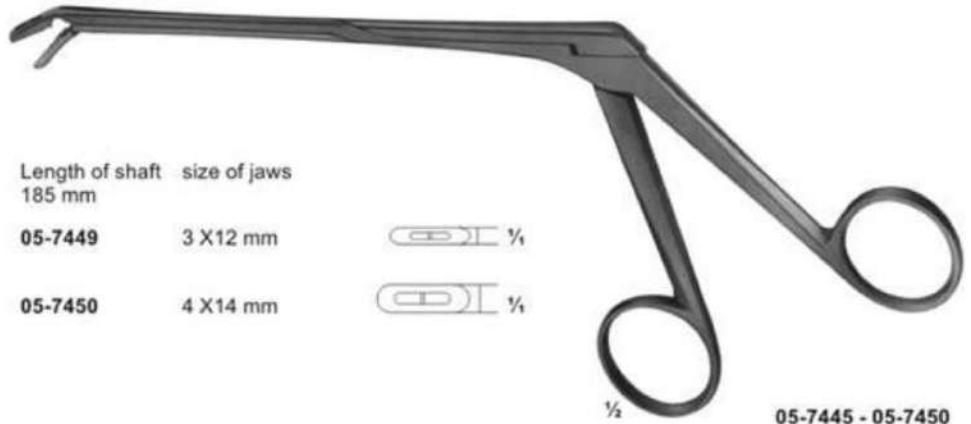
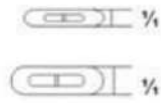

1/2 **05-7445 - 05-7450**  
CASPAR



**05-7451**  
2 X 10 mm  
CUSHING

**05-7452**  
3 X 10 mm  
LOVE-GRUENWALD

**05-7453**  
4 X 10 mm  
SPURLING

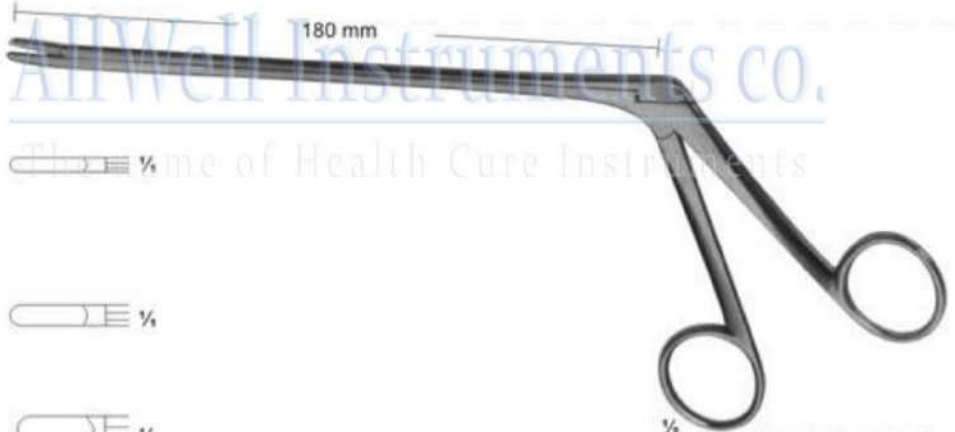
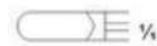

1/2 **05-7451 - 05-7453**

**150°**

**05-7454**  
3 X 10 mm  
LOVE-GRUENWALD

**05-7455**  
4 X 10 mm  
SPURLING



1/2 **05-7454 - 05-7455**

# Rongeurs

**150°**

Upper part of jaw  
movable

**05-7456**  
3 X 10 mm  
LOVE-GRUENWALD

**05-7457**  
4 X 10 mm  
SPURLING

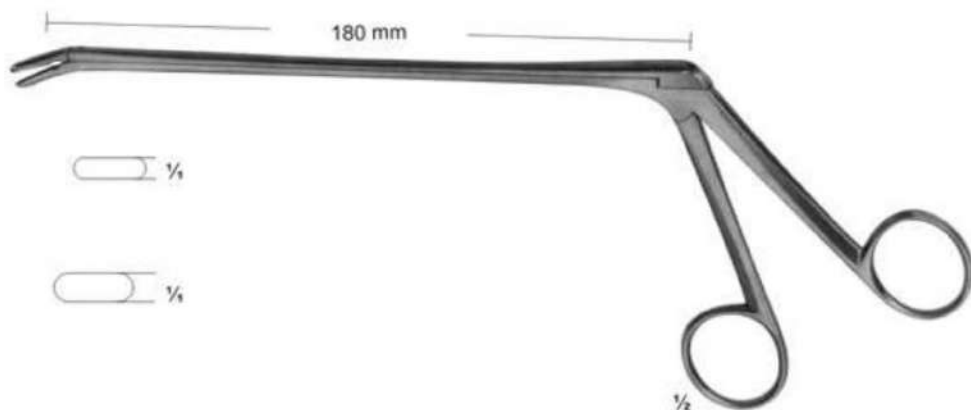

05-7456 - 05-7457



**05-7458**  
∅ 7 mm



05-7458  
OLDBERG

**05-7459**  
YASARGIL  
∅ 2,2 mm

**05-7460**  
YASARGIL  
∅ 3,5 mm

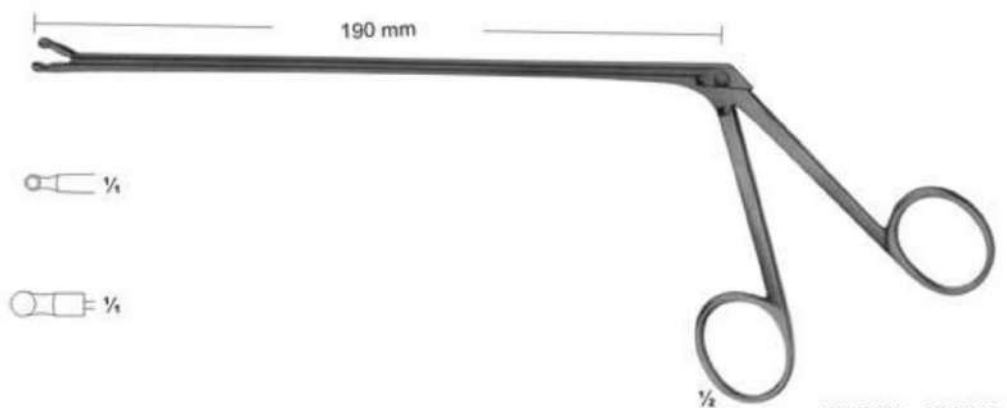

05-7459 - 05-7460

# Rongeurs

05-7461  
4 mm



Osteophyte Rongeur

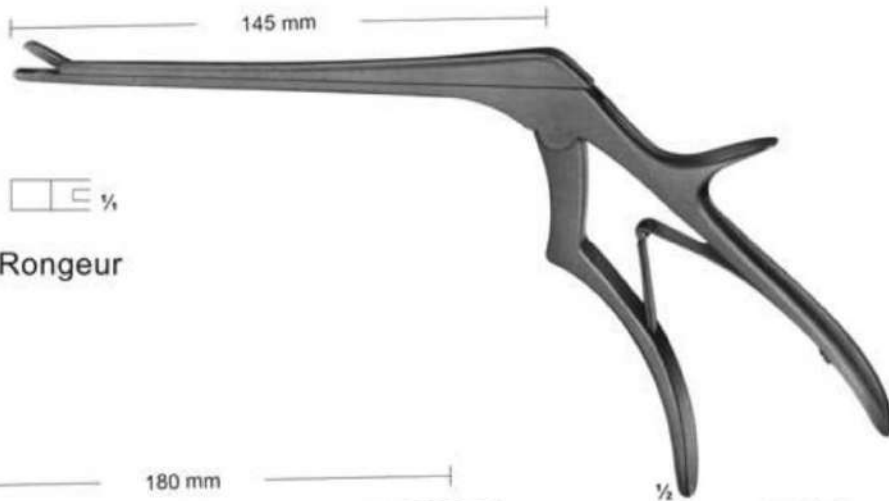

05-7461  
CASPAR

05-7462  
4 mm



Osteophyte Rongeur

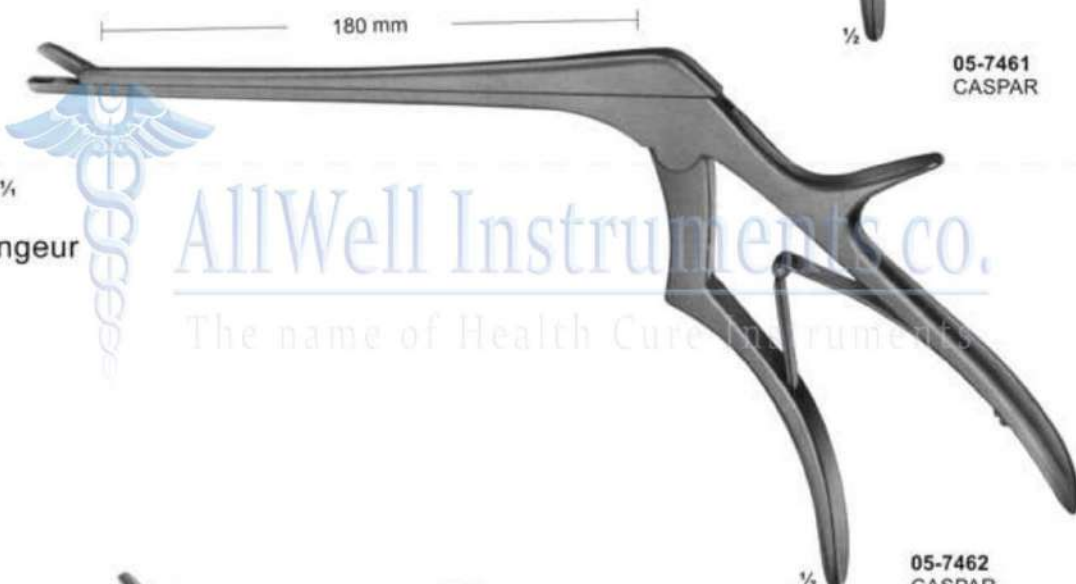

05-7462  
CASPAR

05-7463  
5,5 mm



Very Heavy Pattern

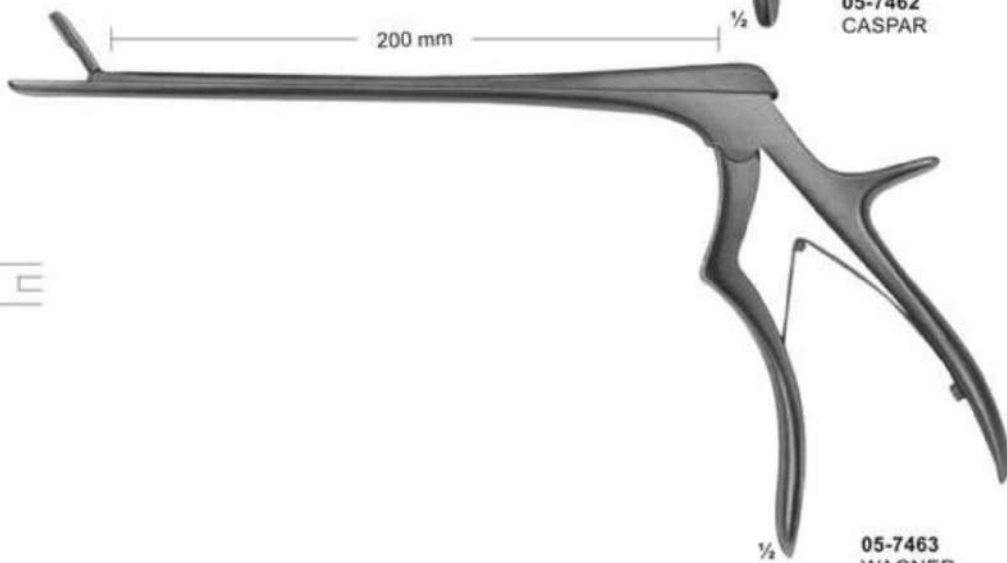

05-7463  
WAGNER



## Section - 06



Allwell Instruments Co.  
The name of Health Care Instruments

Pages 319-392

- ★ Amputation, Elevators, Raspatories, Saws, Bone Livers, Bone Files & Curettes
- ★ Mallets, Tampers, Chisels, Gauges, Bone Holding Forceps, Bone Rongeurs, Bone Cutting Forceps, Meniscus Instruments
- ★ Wire Extension, Finger Nail Instruments



## Amputation and Resection Knives



## Amputation Retractors

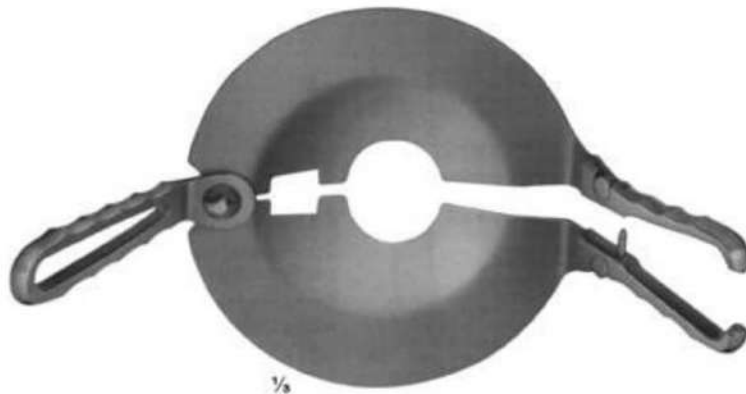

1/8



06-8006  
PERCY  
removeable handles

AllWell Instruments co.

The name of Health Care Instruments



1/8

06-8007  
PERCY  
reversible handles



## Amputation Saws



1/3

**06-8008**  
CHARRIERE  
Length of blade  
215 mm  
complete with one saw  
blade each(**06-8009** and **06-8010**)  
350 mm

Spare saw blades, carbon steel  
**06-8009** 12 mm  
**06-8010** 20 mm



1/3

**06-8011**  
RUST  
Length of blade  
235 mm  
complete with one saw  
blade each(**06-8013**, **06-8014**  
and 2 saw blades **06-8015**)  
390 mm  
**06-8012** Bow only

Spare saw blades, carbon steel  
**06-8013** 6 mm  
**06-8014** 8 mm  
**06-8015** 12 mm  
**06-8016** 20 mm

## Amputation Saws



1/2

**06-8017**  
**BIER**  
 Length of blade  
 270 mm  
 complete with one saw  
 blade each(**06-8018**, **06-8019** and **06-8020**)  
 420 mm

Spare saw blades, carbon steel  
**06-8018** 4 mm  
**06-8019** 6 mm  
**06-8020** 8 mm



1/2

**06-8021**  
**CHARRIERE**  
 Length of blade  
 180 mm  
 Spare saw blade,  
 carbon steel (**06-8022**)  
 270 mm

**06-8023**  
**CHARRIERE**  
 Length of blade  
 240 mm  
 Spare saw blade,  
 carbon steel(**06-8024**)  
 340 mm



1/2

**06-8025**  
**SATTERLEE**  
 Length of blade  
 200 mm  
 Spare saw blade,  
 carbon steel(**06-8026**)  
 200 mm



1/2

**06-8027**  
**LANGENBECK**  
 Length of blade  
 115 mm  
 Metacarpal saw  
 235 mm

## Wire Saws And Conductor



**06-8028 - 06-8031**  
OLIVECRONA  
06-8028 300 mm  
06-8029 400 mm  
06-8030 500 mm  
06-8031 700 mm

**06-8032 - 06-8035**  
GIGLI  
06-8032 300 mm  
06-8033 400 mm  
06-8034 500 mm  
fine, 6 wires twisted  
06-8035 500mm  
coarse, 4 wires twisted



**06-8036**  
GIGLI  
Handle



**06-8037**  
LEBSCHER  
Conductor for  
wire saws, malleable  
250 mm



# Elevators and Bone Levers

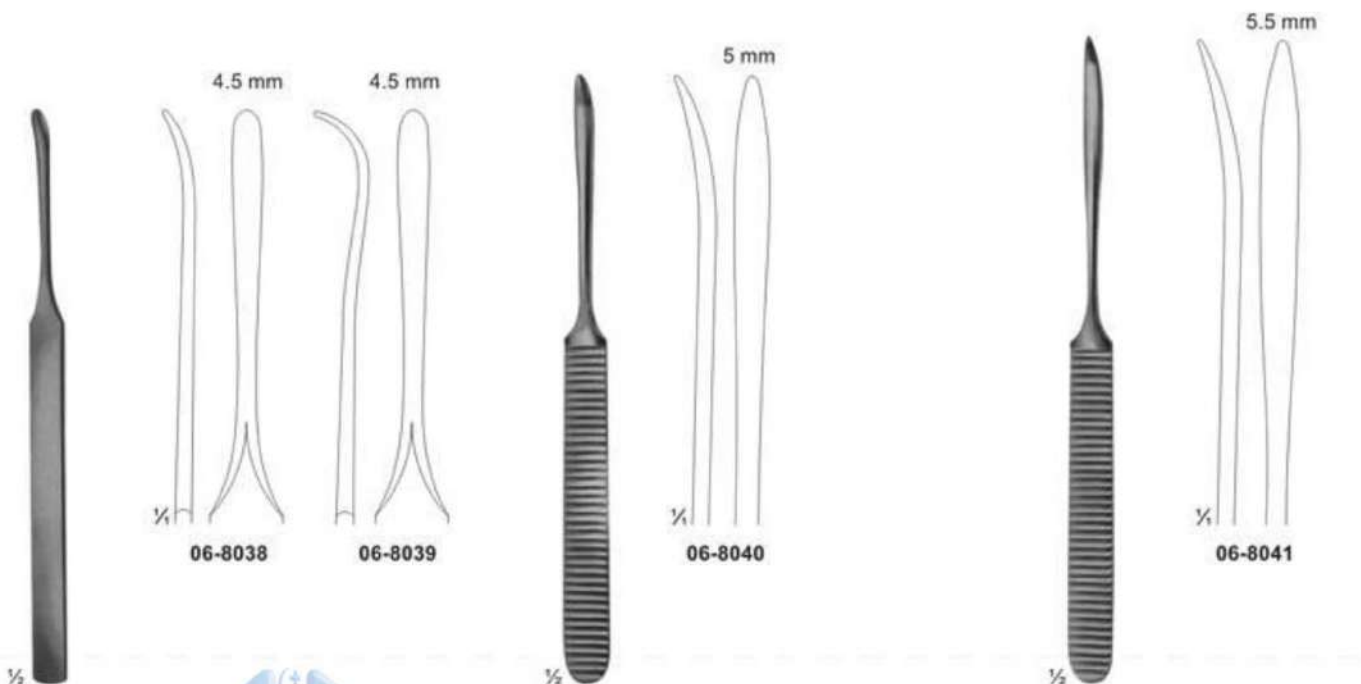

**06-8038 - 06-8039**  
**KOENIG**  
155 mm

**06-8040**  
**WILLIGER**  
165 mm

**06-8041**  
**WILLIGER**  
170 mm



**06-8042**  
**QUERVAIN**  
195 mm

**06-8043 - 06-8044**  
**LANGENBECK**  
195 mm

**06-8045**  
**LANGENBECK**  
230mm

# Bone Levers

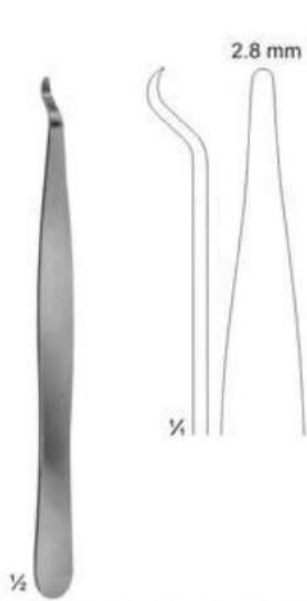

**06-8046**  
140mm

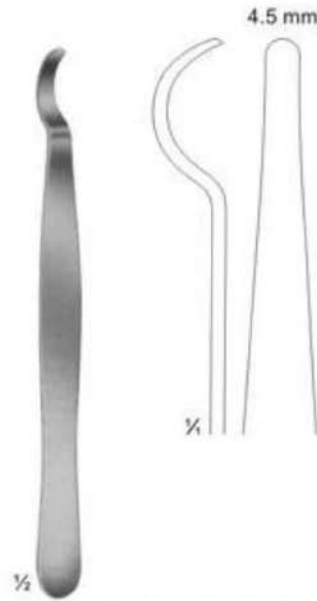

**06-8047**  
150mm

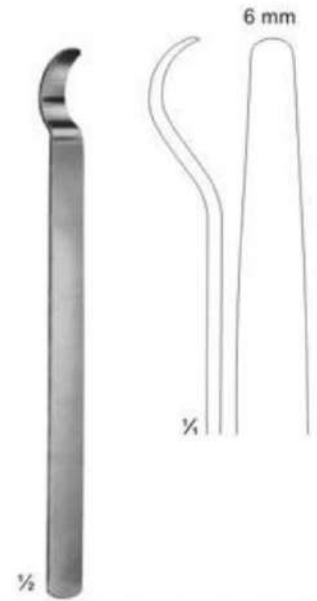

**06-8048**  
150mm



**AllWell Instruments co.**

The name of Health Care Instruments

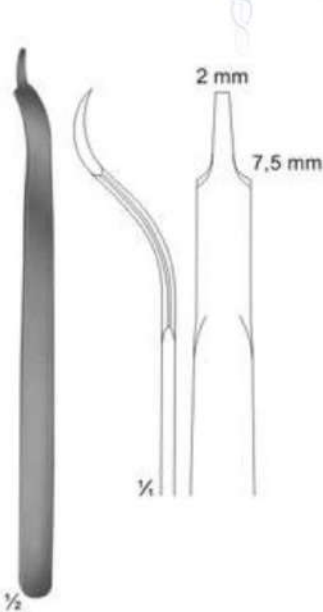

**06-8049**  
BUCK-GRAMCKO  
150mm



**06-8050**  
160mm

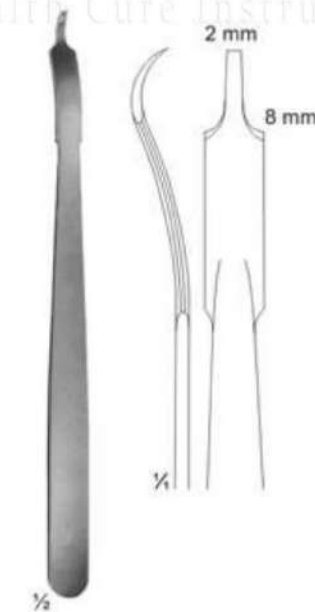

**06-8051**  
160mm

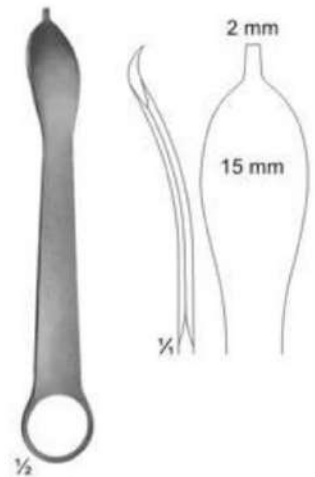

**06-8052**  
125mm

# Bone Levers



**06-8053**  
LANE TRETHOWAN  
215mm

**06-8054**  
LANE  
255mm

**06-8055**  
LANGE-HOHMANN  
250mm

**06-8056 - 06-8057**  
LANGE-HOHMANN  
modif  
**06-8056** 265mm  
**06-8057** 280mm

**06-8056**  
30mm  
**06-8057**  
33mm



# Bone Levers



**06-8058**  
WAGNER  
220 mm

**06-8059**  
220 mm

**06-8060**  
240 mm

**06-8061**  
240 mm

# Bone Levers

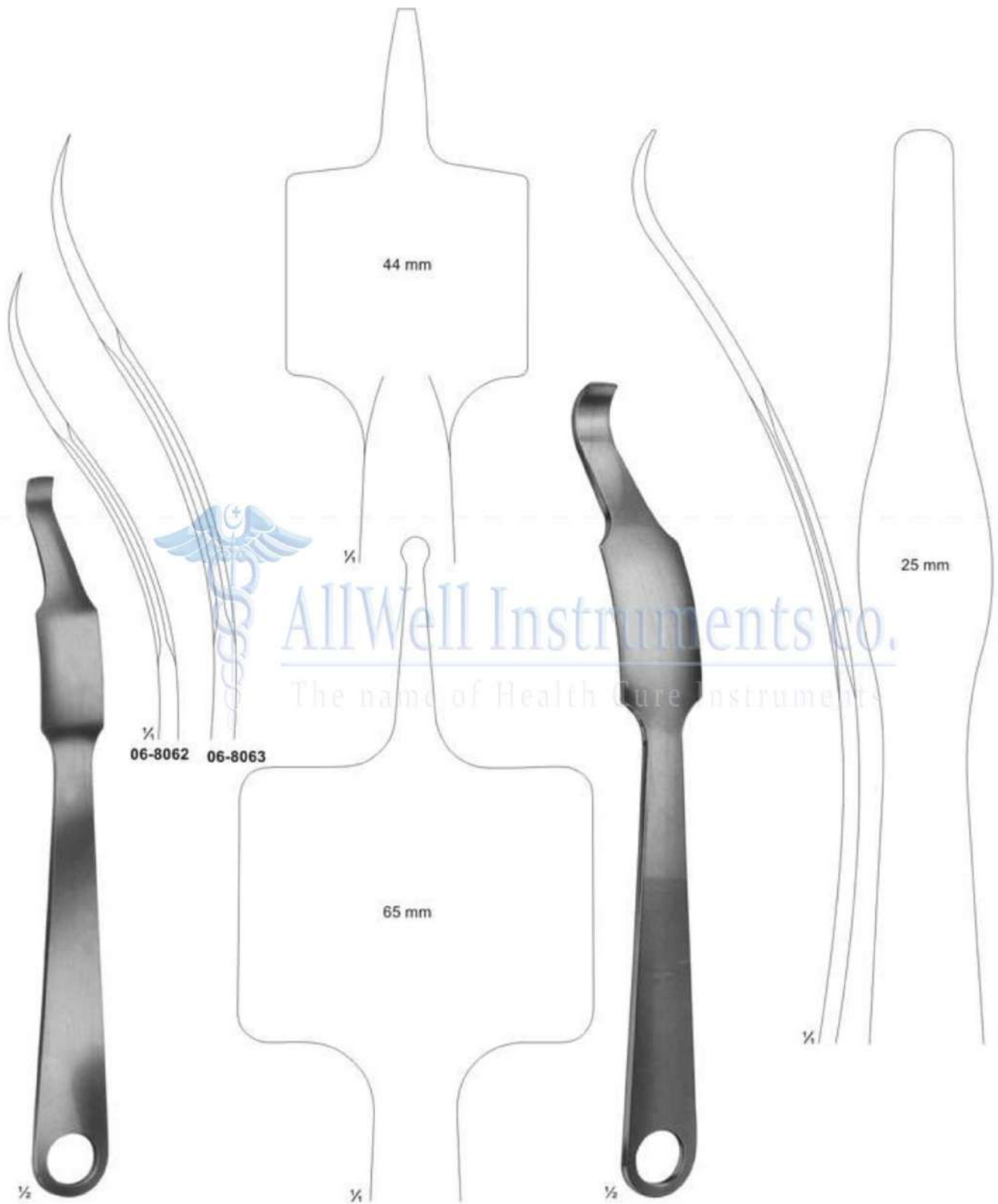

06-8062 06-8063

**06-8062 - 06-8063**  
**VERBRUGGE-MULLER**  
06-8062 240 mm  
06-8063 255 mm

**06-8064**  
260 mm

# Bone Levers



**06-8065**  
HOHMANN-ALDINGER  
270 mm

**06-8066**  
SCHUMACHER mod. WAGNER  
345 mm

**06-8067**  
SCHUMACHER  
290 mm



## Special Bone Levers

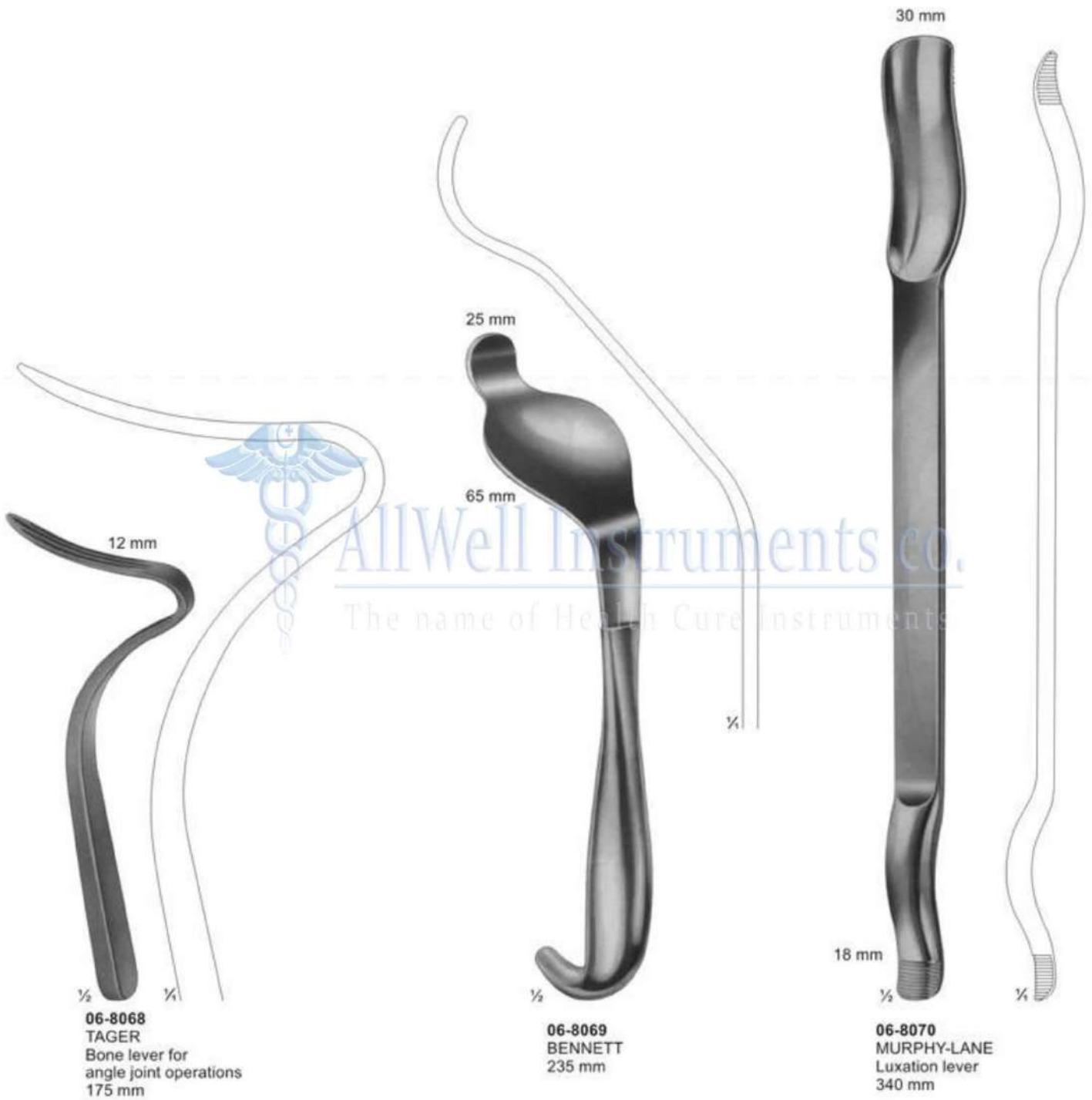

# Raspatories

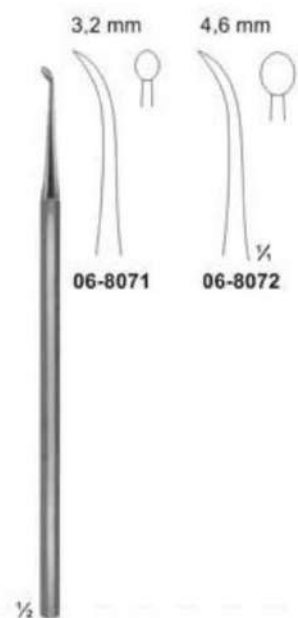

**06-8071 - 06-8072**  
PARTSCH  
150 mm

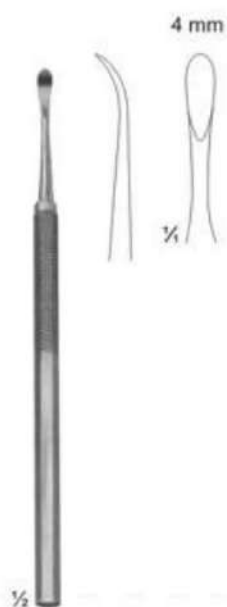

**06-8073**  
PARTSCH mod. LANGE  
145 mm

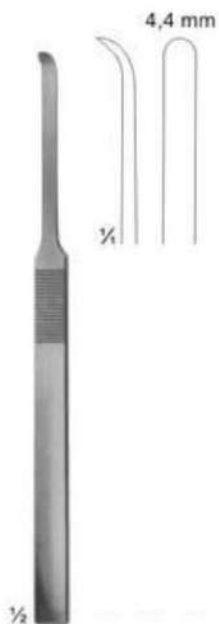

**06-8074**  
MC KENTY  
155 mm

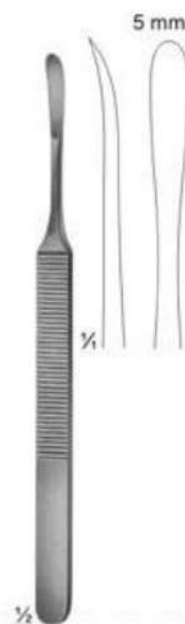

**06-8075**  
KOENIG  
155 mm



**AllWell Instruments co.**

The name of Health Care Instruments

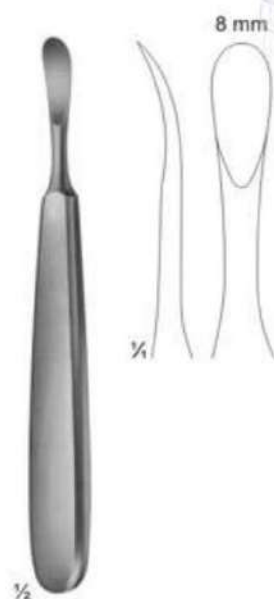

**06-8076**  
TRELAT  
150 mm

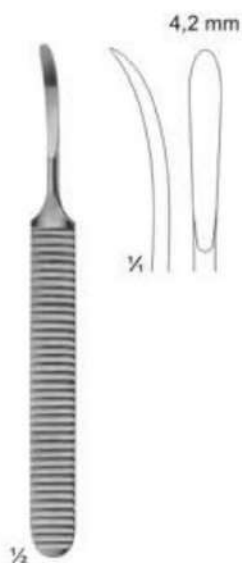

**06-8077**  
WILLIGER  
140 mm



**06-8078**  
WILLIGER  
160 mm

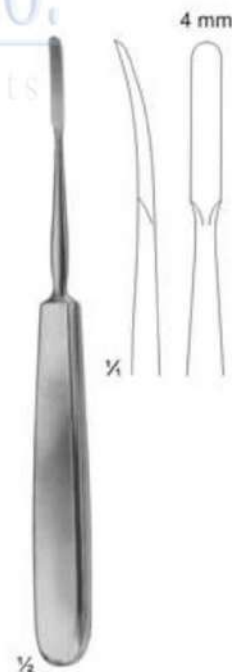

**06-8079**  
JOSEPH  
170 mm

# Raspatories





# Raspatories



**06-8089**  
KILLIAN  
sharp/blunt  
185 mm

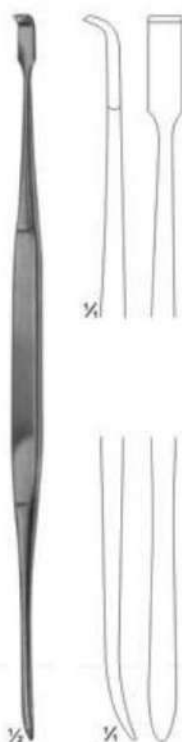

**06-8090**  
HOWARTH  
sharp/blunt  
215 mm

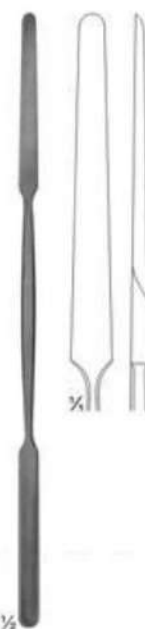

**06-8091**  
KILLIAN  
sharp/blunt  
185 mm

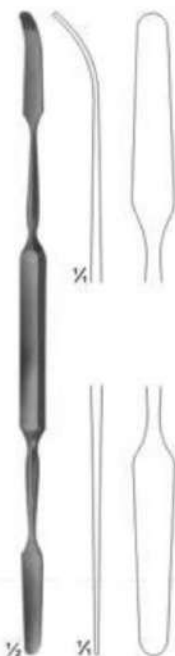

**06-8092**  
MAC DONALD  
blunt/blunt  
185 mm



**06-8093**  
FREER  
sharp/blunt  
185 mm

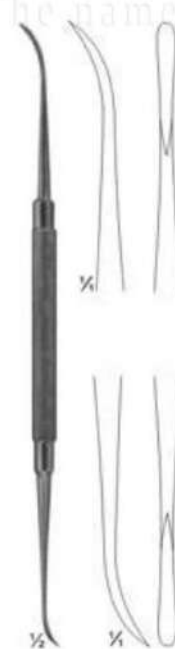

**06-8094**  
FREER-YASARGIL  
sharp/sharp  
185 mm

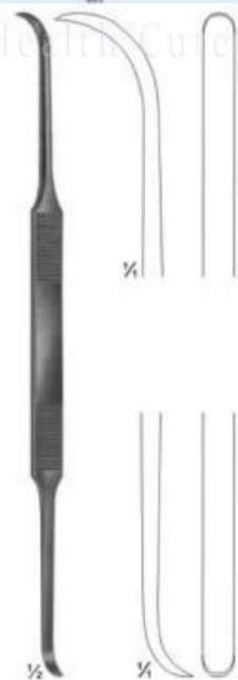

**06-8095**  
COTTLE  
sharp/sharp  
200 mm

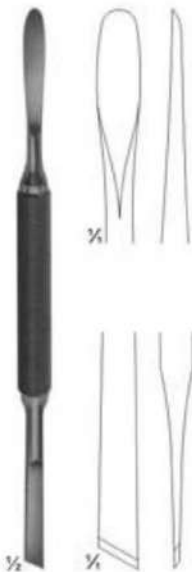

**06-8096**  
MEAD  
sharp/sharp  
165 mm

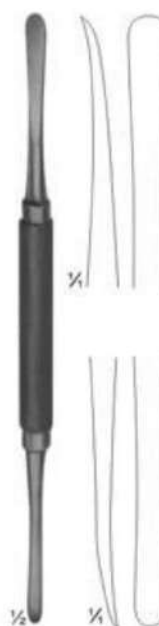

**06-8097**  
MOLT  
sharp/sharp  
180 mm

# Raspatories



**06-8098**  
4 mm

**06-8099**  
7 mm

**06-8100**  
9 mm

**06-8098 - 06-8111**  
MANNERFELT  
modif  
155 mm

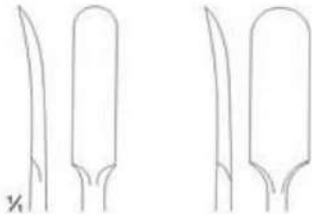

**06-8101**  
6 mm

**06-8102**  
8 mm

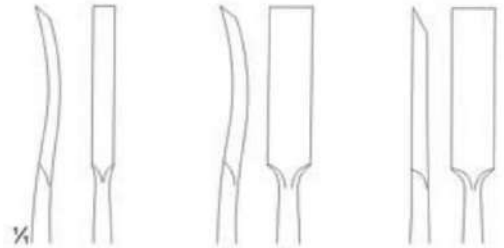

**06-8103**  
3 mm

**06-8104**  
6 mm

**06-8105**  
6 mm



**06-8106**  
4 mm

**06-8107**  
5 mm

**06-8108**  
6 mm



**06-8109**  
4 mm  
90°

**06-8110**  
6 mm  
90°

**06-8111**  
3.5 mm  
45°

AllWell Instruments co.

The name of Health Care Instruments

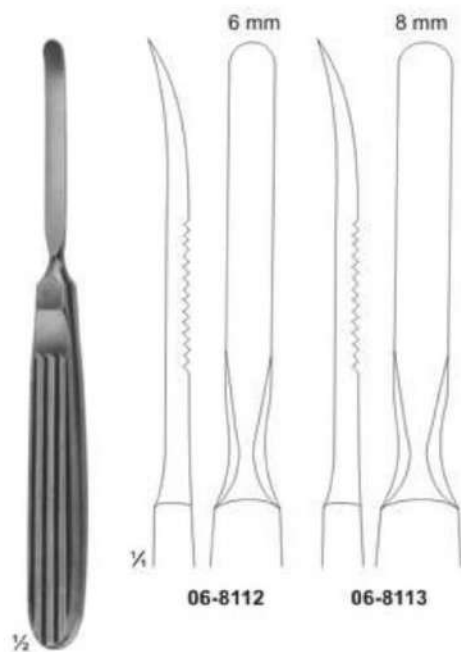

**06-8112**

**06-8113**

**06-8112 - 06-8113**  
165 mm

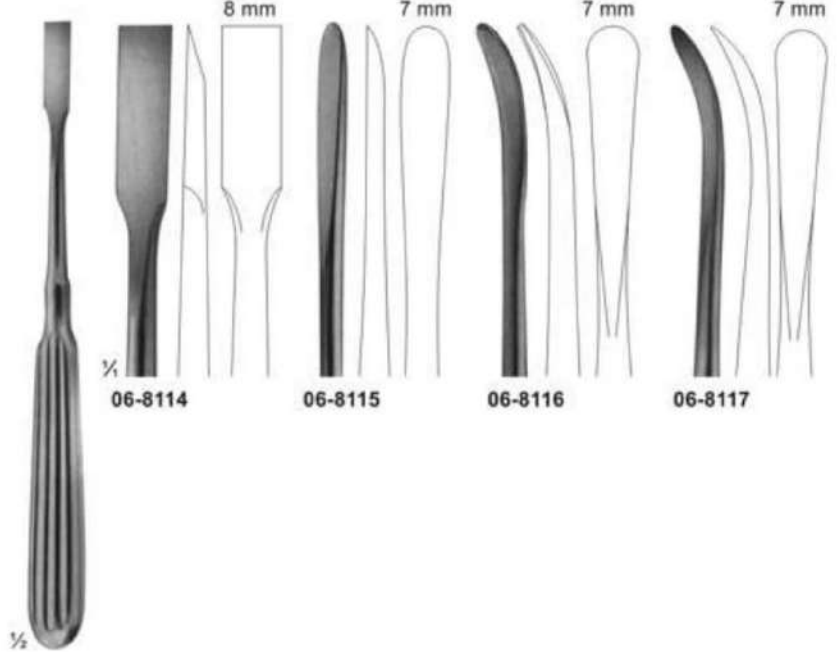

**06-8114**

**06-8115**

**06-8116**

**06-8117**

**06-8114 - 06-8117**  
ADSON  
170 mm

# Raspatories



06-8118 - 06-8121  
MUEHLING  
170 mm

06-8122  
COTTLE  
195 mm



**AllWell Instruments co.**  
The name of Health Care Instruments

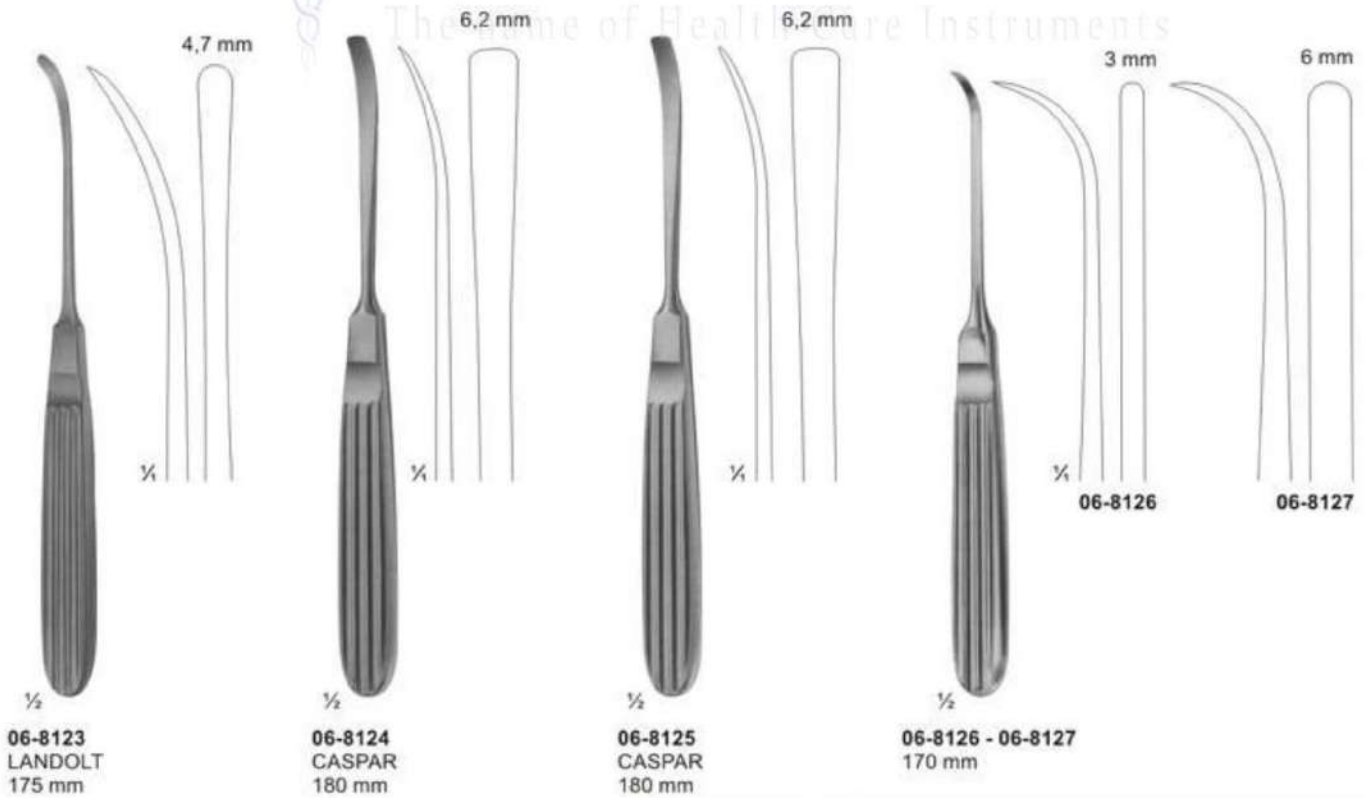

06-8123  
LANDOLT  
175 mm

06-8124  
CASPAR  
180 mm

06-8125  
CASPAR  
180 mm

06-8126 - 06-8127  
170 mm



# Raspatories



**06-8128**  
**FARABEU**  
140 mm

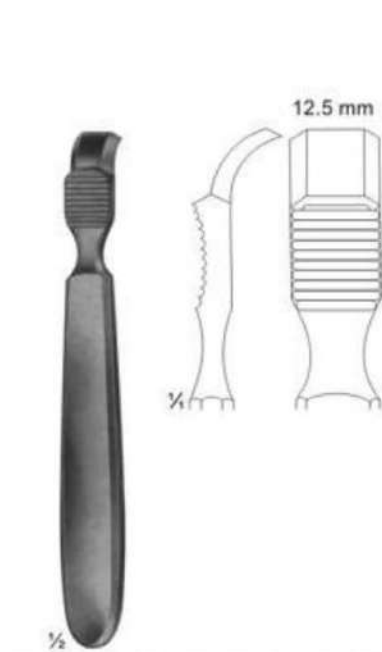

**06-8129**  
**FARABEU**  
140 mm

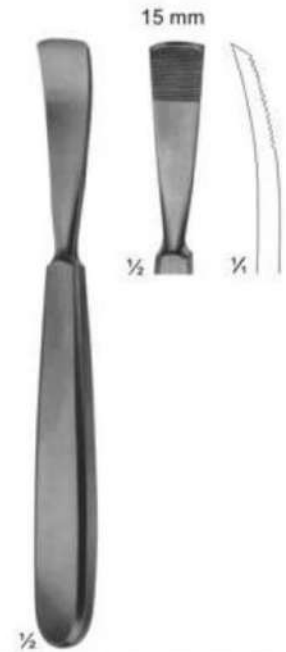

**06-8130**  
**JANSEN**  
165 mm

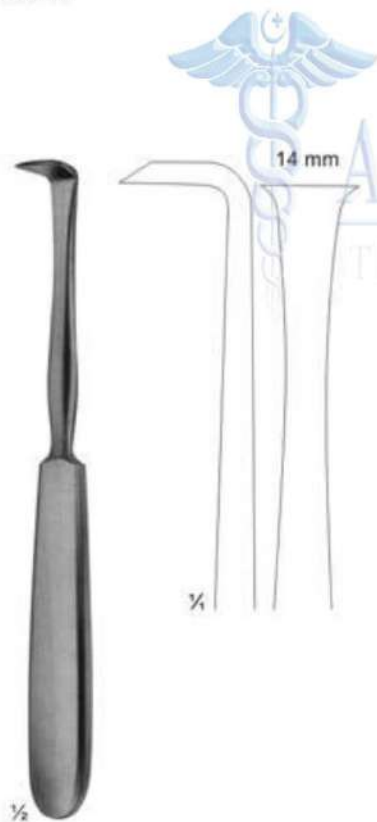

**06-8131**  
**LANGENBECK**  
180 mm



**06-8132**  
**SCHNEIDER**  
175 mm

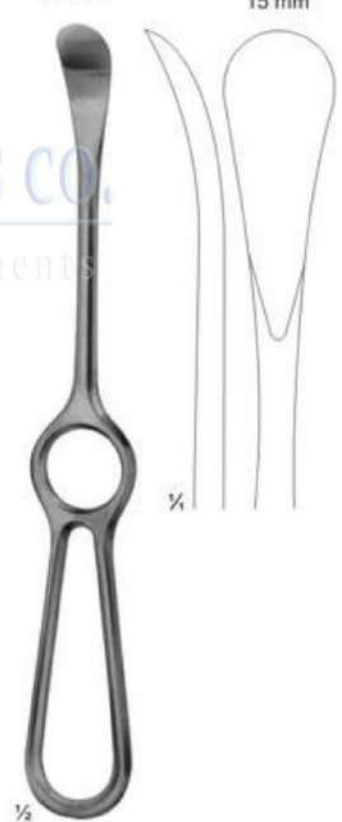

**06-8133**  
**SEDILLOT**  
215 mm

# Raspatories

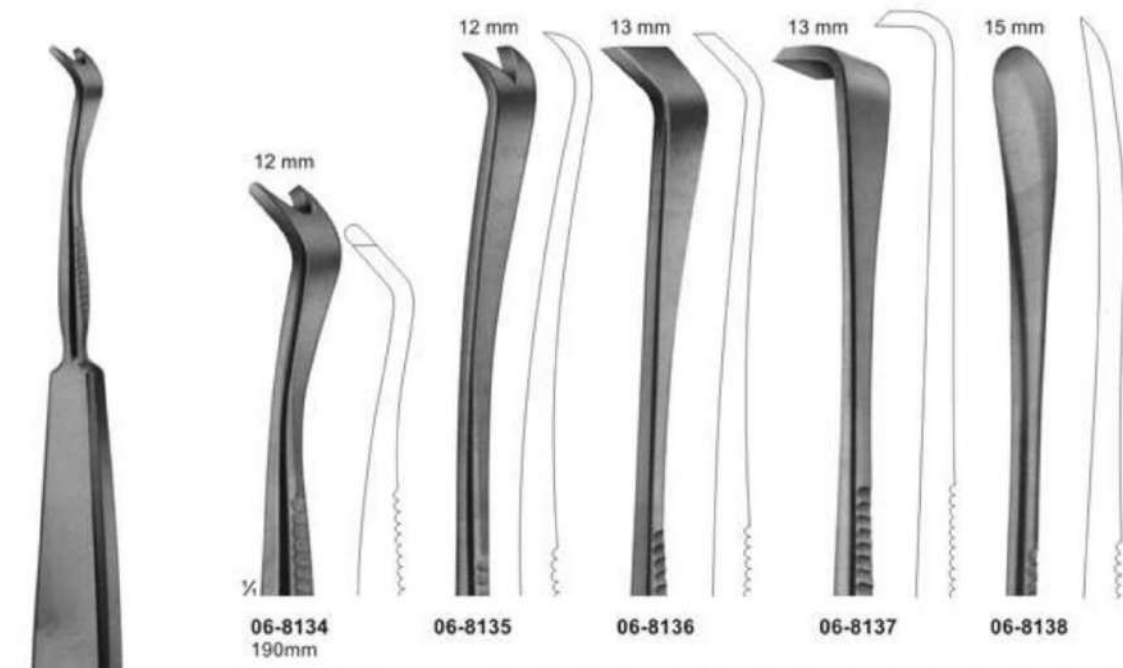

06-8134 - 06-8138  
SEMB  
230 mm



06-8143 - 06-8144  
DOYEN  
240 mm



06-8139 - 06-8140  
DOYEN for children  
06-8141 - 06-8142  
for adults 175 mm

## Raspatories with HARTPRESS-handle





# Bone File and Rasps



**06-8148**  
 JOSEPH  
 fine, chequered  
  
**06-8149**  
 coarse, chequered  
 165 mm

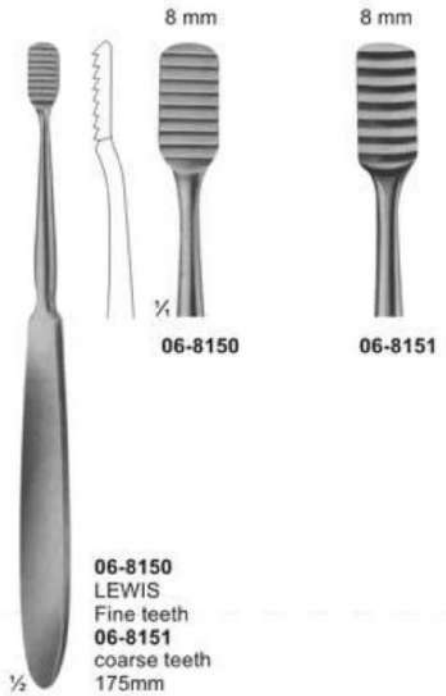

# Bone File and Rasps, Durogrip Rasps

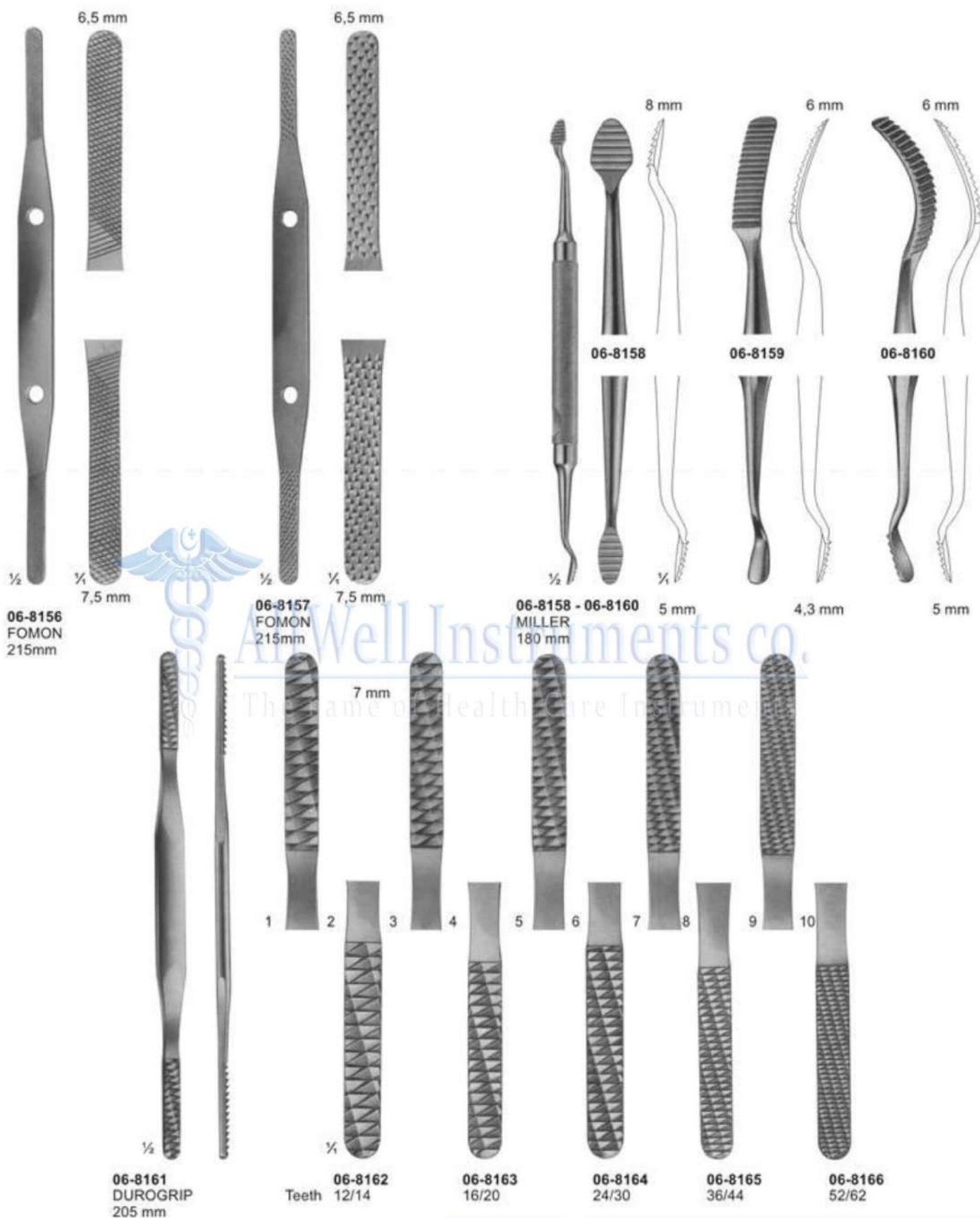

# Bone File and Rasps

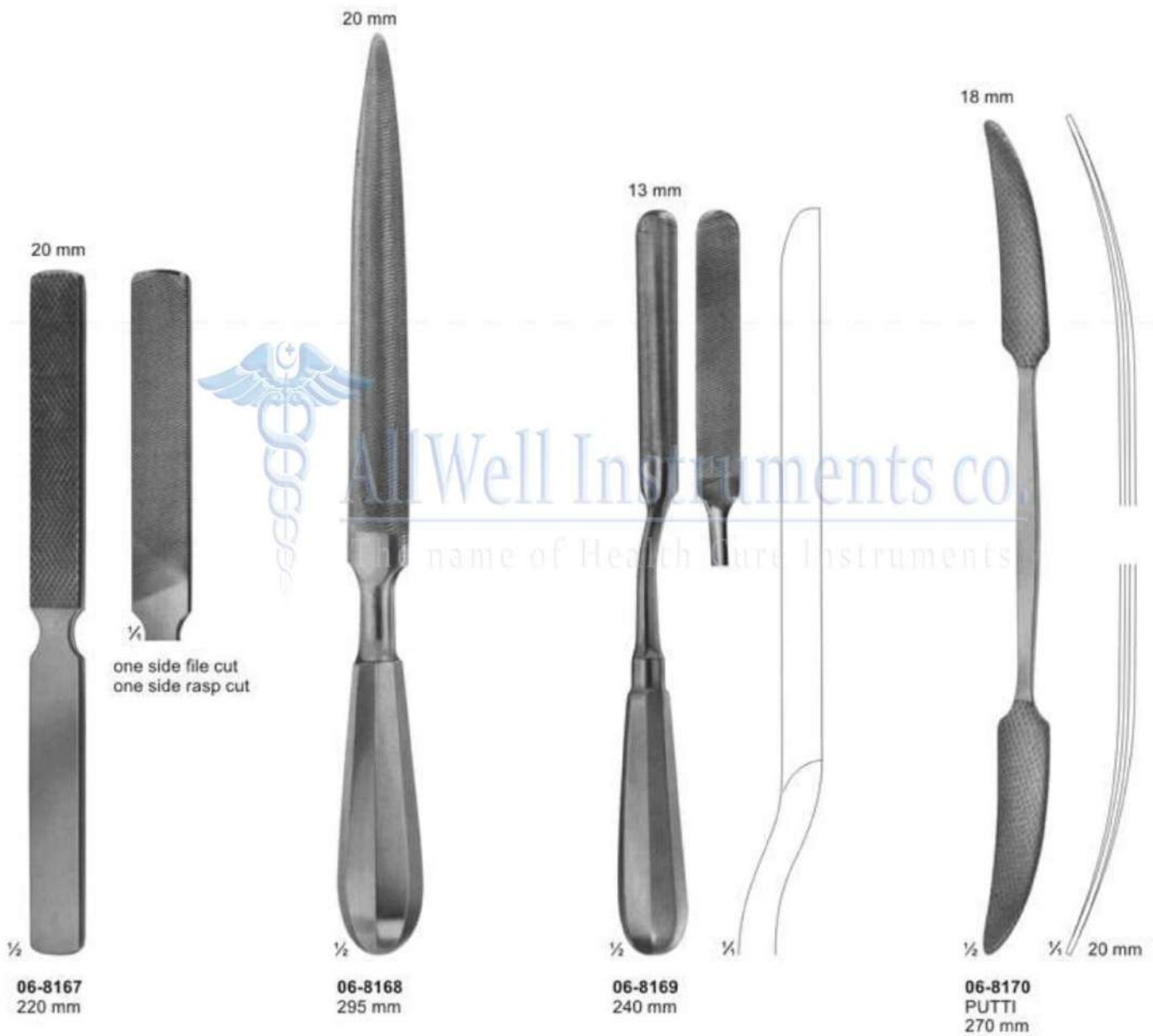



## Bone Currettes



**06-8171**  
JACOBSON  
140 mm



**06-8172**  
MARTINI  
140 mm



**06-8173**  
MARTINI  
140 mm



**06-8174**  
WILLIGER  
145 mm



**06-8175**  
JANSEN  
160 mm



# AllWell Instruments co.

The name of Health Cure Instruments



**06-8176**  
BARTH  
180 mm



**06-8177**  
VOLKMANN  
130 mm



**06-8178**  
VOLKMANN  
145 mm



**06-8179**  
VOLKMANN  
170 mm

# Bone Currettes



**06-8180**  
JANSEN  
160 mm



**06-8181**  
HEMINGWAY  
170 mm



**06-8182**  
HEMINGWAY  
175 mm



**06-8183**  
LUCAS  
180 mm



**06-8184**  
LUCAS  
185 mm

**AllWell instruments co.**

The name of Health Cure Instruments



**06-8185 - 06-8187**  
KERPEL  
145 mm



**06-8186 - 06-8188**  
KERPEL  
145 mm

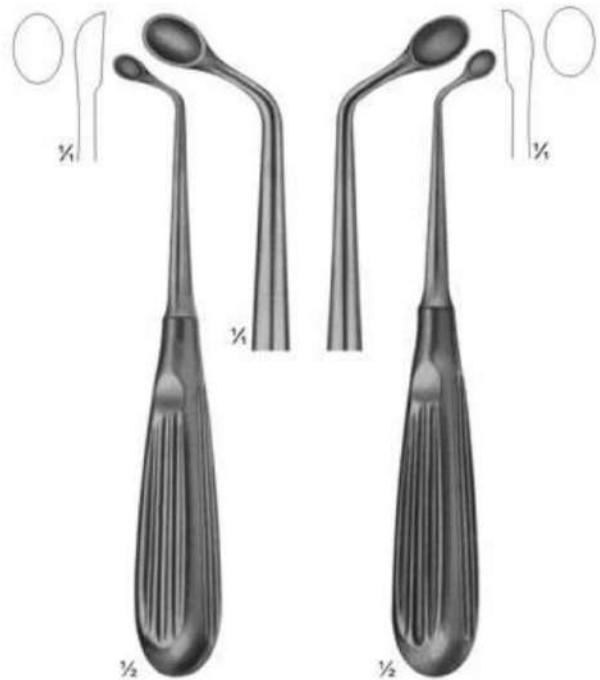

**06-8189**  
UFFENDORDE  
170 mm

**06-8190**  
UFFENDORDE  
170 mm

# Bone Currettes

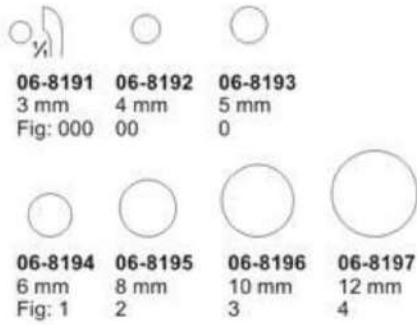

**06-8191 - 06-8197**  
BRUNS  
165 mm

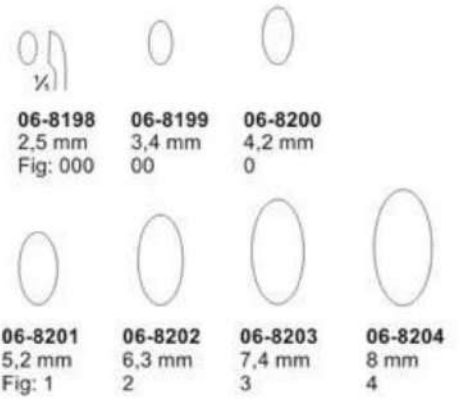

**06-8198 - 06-8204**  
SCHEDE  
170 mm

**AllWell Instruments co.**

The name of Health Cure Instruments

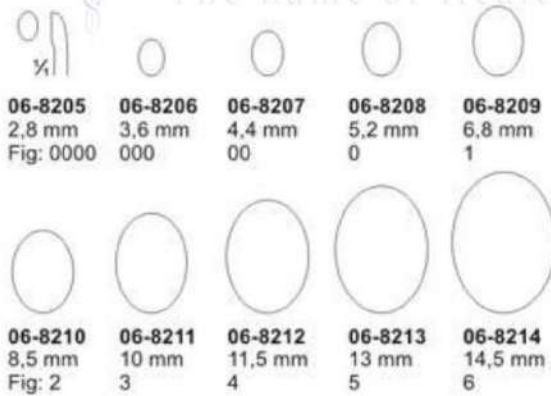

**06-8205 - 06-8214**  
VOLKMANN  
170 mm

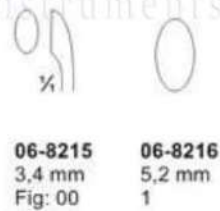





**06-8215 - 06-8216**  
WILLIGER  
170 mm





# Bone Currettes



-  06-8217  
1,8 mm
-  06-8218  
2,0 mm
-  06-8219  
2,4 mm
-  06-8220  
2,6 mm
-  06-8221  
2,8 mm

06-8217 - 06-8221  
LEMPERT  
215 mm



- malleable
-  06-8222  
4,4 mm  
Fig: 00
  -  06-8223  
5,2 mm  
Fig: 0
  -  06-8224  
6,8 mm  
Fig: 1

06-8222 - 06-8224  
HALLE  
215 mm



-  06-8225  
2,8 mm  
Fig: 0000
-  06-8226  
3,6 mm  
Fig: 000
-  06-8227  
4,4 mm  
Fig: 00
-  06-8228  
5,2 mm  
Fig: 0

06-8225 - 06-8228  
DAUBENSPECK  
200 mm



AllWell Instruments co.

The name of Health Cure Instruments



-  06-8229  
3,6 mm  
Fig: 000
-  06-8230  
4,4 mm  
Fig: 00
-  06-8231  
5,2 mm  
Fig: 0
-  06-8232  
6,8 mm  
Fig: 1

06-8229 - 06-8232  
250 mm



-  06-8233  
3,6 mm  
Fig: 000
-  06-8234  
4,4 mm  
Fig: 00
-  06-8235  
5,2 mm  
Fig: 0
-  06-8236  
6,8 mm  
Fig: 1

06-8233 - 06-8236  
250 mm



-  06-8237  
3 mm
-  06-8238  
4 mm
-  06-8239  
5 mm

06-8237 - 06-8239  
BUSHE 250 mm

# Bone Currettes



**06-8240**  
TESSIER  
220 mm



**06-8241 - 06-8243**  
SIMON  
235 mm



**06-8244 - 06-8249**  
SIMON  
240 mm



**06-8250 - 06-8252**  
CASPAR  
220 mm



**06-8253 - 06-8255**  
CASPAR  
220 mm



**06-8256 - 06-8258**  
CASPAR  
toothed  
220 mm



**AllWell Instruments co.**  
The name of Health Cure Instruments

# Bone Currettes With Hartpress Handle

can be sterilized in a steam sterilizer upto 3 bar over pressure (143 C).

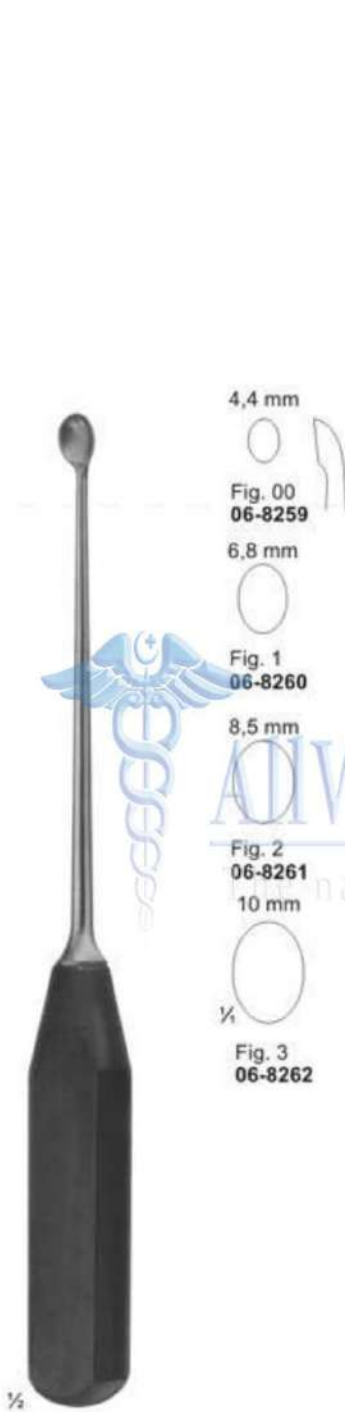

**06-8259 - 06-8262**  
270 mm



**06-8263 - 06-8270**  
SYPERT  
380 mm



## Mallets Weight Refer To The Heads Of The Mallets



**06-8271**  
MEAD  
185 g  
with interchangeable  
plastic disks  
190 mm  
**06-8272**  
pair of spare disks

**06-8273**  
140 g  
with interchangeable  
plastic disks  
185 mm  
**06-8274**  
pair of spare disks

**06-8275**  
COTTLE  
240 g  
1 Side flat  
1 Side convex  
185 mm

**06-8276**  
165 g  
lead filled head  
190 mm

## Mallets, Weights Refer To The Heads Of The



**06-8277**  
HAJEK  
140 g  
220 mm



**06-8278**  
215 g  
with interchangeable  
plastic disks  
245 mm  
**06-8279**  
pair of spare disks



**06-8280 - 06-8283**  
WAGNER  
complete with:  
1 pair of metal disks (**06-8281**) and  
1 pair of plastic disks (**06-8282**) and  
1 wrench (**06-8283**)  
235 mm

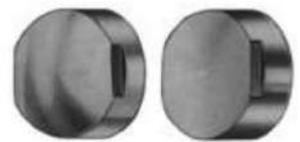

**06-8281** 230g  
1 metal disk, flat  
1 metal disk, convex

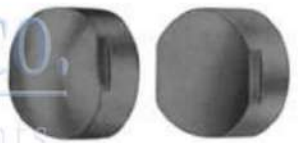

**06-8282** 32g  
1 plastic disk, flat  
1 plastic disk, convex



**06-8283**  
Wrench

## Mallets Weight Refer To The Heads Of The Mallets



06-8284 300g  
BERGMANN  
245 mm



06-8285 300g  
BERGMANN  
235 mm



06-8286 550g  
OMBREDANNE  
240 mm



06-8287  
HEATH  
copper filled head  
700 g  
185 mm



AllWell Instruments co.  
The name of Health Cure Instruments



# Tampers - Osteotomes, Chisels and Gouges



**06-8288**  
HAASE  
100 mm



**06-8289 - 06-8290**  
PASSOW  
120 mm



**06-8291 - 06-8293**  
CASPAR  
200 mm



**06-8294 - 06-8296**  
200 mm



AllWell Instruments co.

The name of Health Care Instruments



**06-8297** 4mm  
FREER  
Chisel  
160 mm



**06-8298** 4mm  
FREER  
Chisel, curved  
160 mm



**06-8299** 6mm  
FREER  
Gouge  
150 mm



**06-8300** 3.4mm  
Scaphoid gouge,  
downwards curved  
135 mm



**06-8301** 3.4mm  
Scaphoid gouge,  
upwards curved  
135 mm



**06-8302 - 06-8304**  
MANNERFELT modif  
Osteotomes  
**06-8302** 4 mm  
**06-8303** 6 mm  
**06-8304** 8 mm  
155 mm

# Osteotomes Chisels and Gouges



06-8305 3mm  
MANNERFELT modif.  
Gouge  
155 mm



06-8306 - 06-8310  
Osteotomes  
140 mm

- 06-8306 4 mm
- 06-8307 6 mm
- 06-8308 8 mm
- 06-8309 10 mm
- 06-8310 12 mm



06-8311 - 06-8315  
Chisels  
140 mm

- 06-8311 4 mm
- 06-8312 6 mm
- 06-8313 8 mm
- 06-8314 10 mm
- 06-8315 12 mm



06-8316 - 06-8320  
Gouges  
140 mm

- 06-8316 4 mm
- 06-8317 6 mm
- 06-8318 8 mm
- 06-8319 10 mm
- 06-8320 12 mm

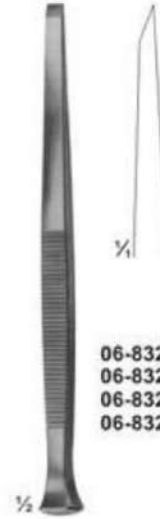

PARTSCH  
06-8321 - 06-8324  
Chisels  
140 mm

- 06-8321 3 mm
- 06-8322 4 mm
- 06-8323 5 mm
- 06-8324 6 mm



**AllWell Instruments co.**

The name of Health Cure Instruments



PARTSCH  
06-8325 - 06-8329  
Chisels  
170 mm

- 06-8325 3 mm
- 06-8326 4 mm
- 06-8327 5 mm
- 06-8328 6 mm
- 06-8329 7 mm



PARTSCH  
06-8330 - 06-8333  
Gouges  
140 mm

- 06-8330 3 mm
- 06-8331 4 mm
- 06-8332 5 mm
- 06-8333 6 mm



PARTSCH  
06-8334 - 06-8338  
Gouges  
170 mm

- 06-8334 3 mm
- 06-8335 4 mm
- 06-8336 5 mm
- 06-8337 6 mm
- 06-8338 7 mm



LUCAS  
06-8339 - 06-8340  
Chisels  
160 mm

- 06-8339 4 mm
- 06-8340 6 mm



LUCAS  
06-8341 - 06-8342  
Gouges  
160 mm

- 06-8341 3 mm
- 06-8342 5 mm

# Osteotomes Chisels and Gouges



06-8343 5 mm  
06-8344 7 mm  
06-8345 9 mm  
06-8346 11 mm

**ALEXANDER**  
06-8343 - 06-8346  
Gouges  
170 mm

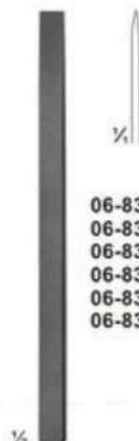

06-8347 4 mm  
06-8348 6 mm  
06-8349 8 mm  
06-8350 10 mm  
06-8351 12 mm  
06-8352 15 mm

**LAMBOTTE**  
06-8347 - 06-8352  
Osteotomes  
125 mm

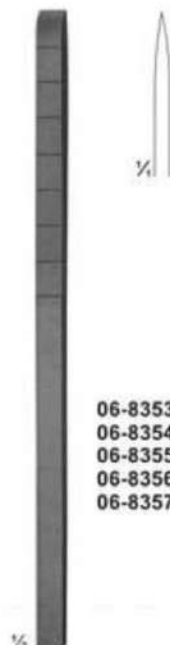

06-8353 4 mm  
06-8354 6 mm  
06-8355 8 mm  
06-8356 10 mm  
06-8357 12 mm

**COTTLE**  
06-8353 - 06-8357  
Osteotomes with depth  
markings  
180 mm

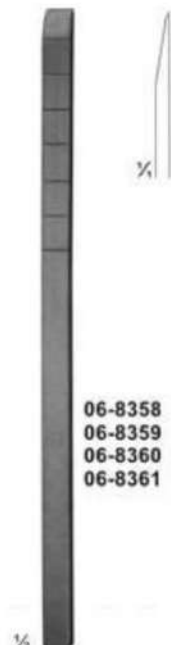

06-8358 4 mm  
06-8359 7 mm  
06-8360 9 mm  
06-8361 12 mm

**COTTLE**  
06-8358 - 06-8361  
Chisel-Osteotomes  
with depth markings  
180 mm



**COTTLE**  
06-8362 8mm  
Fishtail Chisel,  
with protected ends  
180 mm



06-8363 10 mm  
06-8364 12 mm  
06-8365 15 mm  
06-8366 20 mm  
06-8367 25 mm

**STILLE**  
06-8363 - 06-8367  
Chisels  
205 mm



06-8368 10 mm  
06-8369 12 mm  
06-8370 15 mm  
06-8371 20 mm  
06-8372 25 mm

**STILLE**  
06-8368 - 06-8372  
Gouges  
205 mm

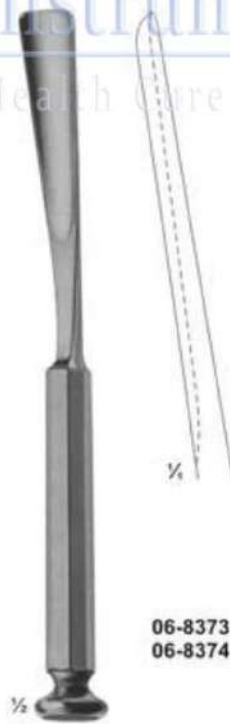

06-8373 10 mm  
06-8374 15 mm

**WALTER**  
06-8373 - 06-8374  
gouges for taking  
grafts from the ribs  
205 mm







06-8375 8mm  
06-8376 10 mm  
06-8377 12 mm  
06-8378 15 mm  
06-8379 20 mm  
06-8380 25 mm

**STILLE**  
06-8375 - 06-8380  
Osteotomes  
205 mm



# Osteotomes

	<b>06-8381</b> 10 mm		<b>06-8386</b> 10 mm		<b>06-8391</b> 4 mm		
	<b>06-8382</b> 12 mm		<b>06-8387</b> 12 mm		<b>06-8392</b> 8 mm		
	<b>06-8383</b> 15 mm		<b>06-8388</b> 15 mm		<b>06-8393</b> 10 mm		
	<b>06-8384</b> 20 mm		<b>06-8389</b> 20 mm		<b>06-8394</b> 13 mm		
	<b>06-8385</b> 25 mm		<b>06-8390</b> 25 mm		<b>06-8395</b> 15 mm		
					<b>06-8396</b> 18 mm		<b>06-8403</b> 8 mm
					<b>06-8397</b> 20 mm		<b>06-8404</b> 13 mm
					<b>06-8398</b> 25 mm		<b>06-8405</b> 18 mm
					<b>06-8399</b> 30 mm		<b>06-8406</b> 25 mm
					<b>06-8400</b> 38 mm		<b>06-8407</b> 30 mm
				<b>06-8401</b> 44 mm	<b>06-8408</b> 38 mm		
				<b>06-8402</b> 50 mm			

**STILLE**  
**06-8381 - 06-8385**  
Osteotomes  
205 mm

**STILLE**  
**06-8386 - 06-8390**  
Osteotomes, curved  
205 mm

**LAMBOTTE**  
**06-8391 - 06-8402**  
Osteotomes  
245 mm

**LAMBOTTE**  
**06-8403 - 06-8408**  
Osteotomes, curved  
245 mm

# Osteotomes, Chisels and Gouges with HARTPRESS -handle

	<p>06-8409 4 mm 06-8410 6 mm 06-8411 8 mm 06-8412 10 mm 06-8413 12 mm</p>		<p>06-8414 4 mm 06-8415 6 mm 06-8416 8 mm 06-8417 10 mm 06-8418 12 mm</p>		<p>06-8419 5 mm 06-8420 7 mm 06-8421 10 mm 06-8422 15 mm 06-8423 20 mm 06-8424 25 mm 06-8425 30 mm</p>
<p>LEXER-MINI 06-8409 - 06-8413 Osteotomes 180 mm</p>		<p>LEXER-MINI 06-8414 - 06-8418 Gouges 180 mm</p>	<p>LEXER 06-8419 - 06-8425 Gouges 220 mm</p>		
	<p>06-8426 5 mm 06-8427 7 mm 06-8428 10 mm 06-8429 15 mm 06-8430 20 mm 06-8431 25 mm 06-8432 30 mm</p>	<p>06-8433 9mm Gouge for removing broken screws 220 mm</p>		<p>06-8434 5,5 mm 06-8435 9,0 mm</p>	<p>ZIELKE 06-8434 - 06-8435 Gouges for scoliosis-operations 230 mm</p>

# Osteotomes ,Chisels and Gouges with HARTPRESS -handle

**AllWell Instruments co.**  
The name of Health Care Instruments

<p>1/2</p> <p><b>LEXER</b> <b>06-8436 - 06-8437</b> Osteotomes, angled 275 mm</p>	<p>1/4</p> <p><b>06-8436</b> 10 mm <b>06-8437</b> 15 mm</p>	<p>1/2</p> <p><b>LEXER</b> <b>06-8438 - 06-8439</b> Gouges, angled 275 mm</p>	<p>1/4</p> <p><b>06-8438</b> 10 mm <b>06-8439</b> 15 mm</p>	<p>1/2</p> <p><b>06-8440</b> 20mm Chisel 245 mm</p>	<p>1/4</p> <p><b>06-8441</b> 16mm Chisel, curved 265 mm</p>
---	---	---	---	---	---



## Reposition Forceps



**06-8442**  
Reposition forceps,  
for small fragments  
135 mm



**06-8443**  
**HAASE**  
Reposition forceps,  
for mandibular  
fractures  
165 mm



**06-8444**  
**REILL**  
Reposition forceps,  
170 mm



**06-8445**  
Reposition forceps  
205 mm



**06-8446**  
**MEYER**  
Reposition forceps  
for fingers, with drill  
guide for KIRSCHNER  
wires up to diam. 1.0 mm  
170 mm

**AllWell Instruments co.**

The name of Health Care Instruments

## Reposition Forceps, Bone Holding Forceps



**06-8447**  
Patella forceps  
185 mm



**06-8448**  
Forceps with  
ratchet fixation  
140 mm



**06-8449**  
Forceps with  
thread fixation  
170 mm



**06-8450**  
Forceps with  
thread fixation  
235 mm

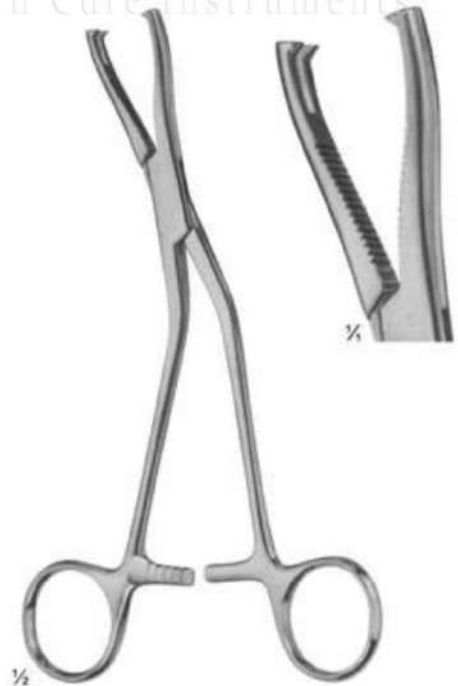

**06-8451**  
DINGMANN modif  
185 mm

# Bone Holding Forceps

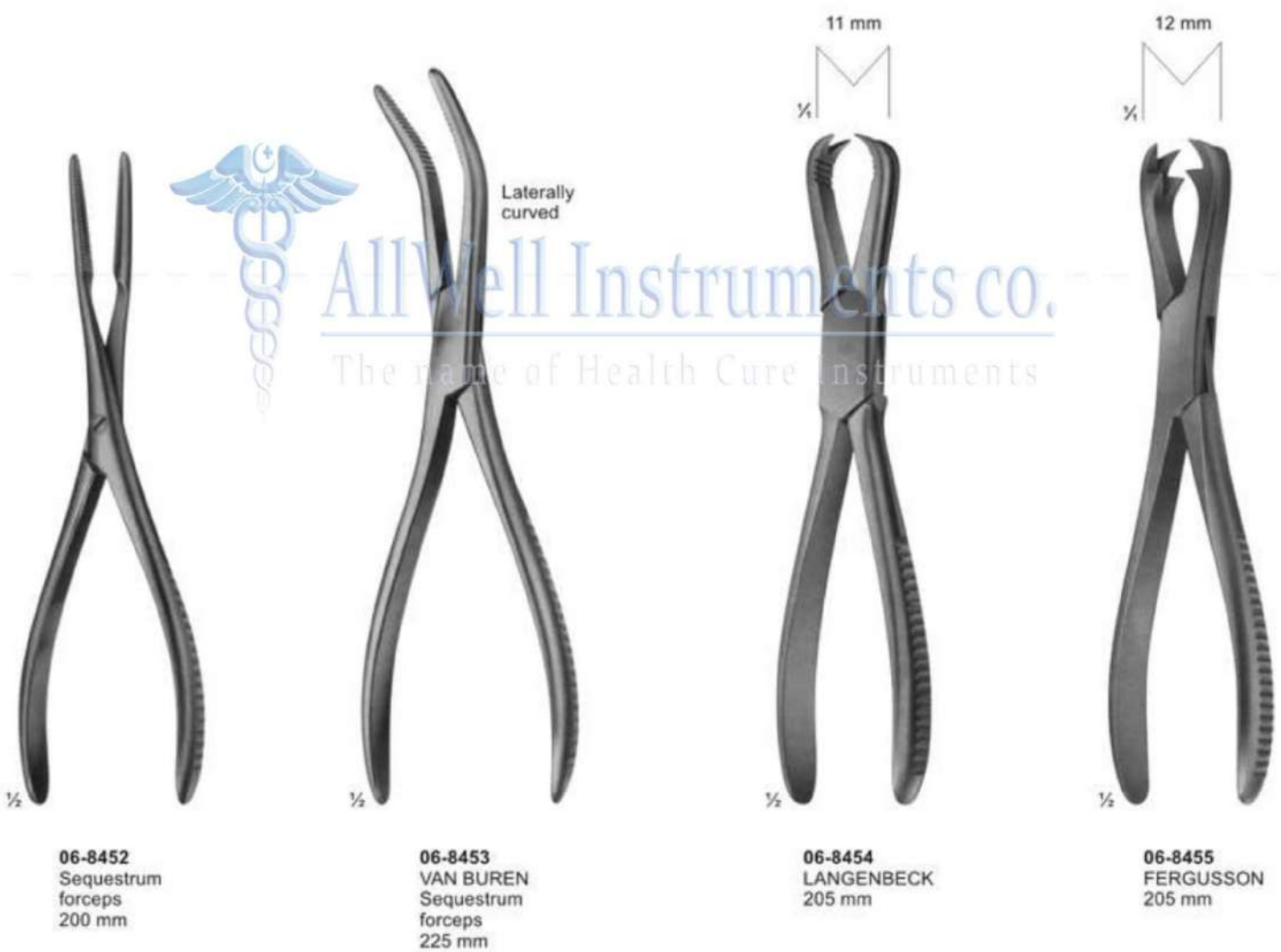



# Bone Holding Forceps

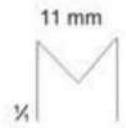
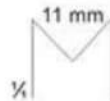
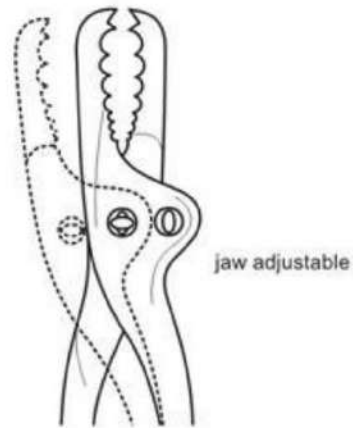

8 mm



**06-8456**  
SEMB  
190 mm



**06-8457**  
FARABEU  
230 mm



**06-8458**  
FARABEU  
255 mm



**06-8459**  
FARABEU-LAMBOTTE  
255 mm

## Bone Holding Forceps

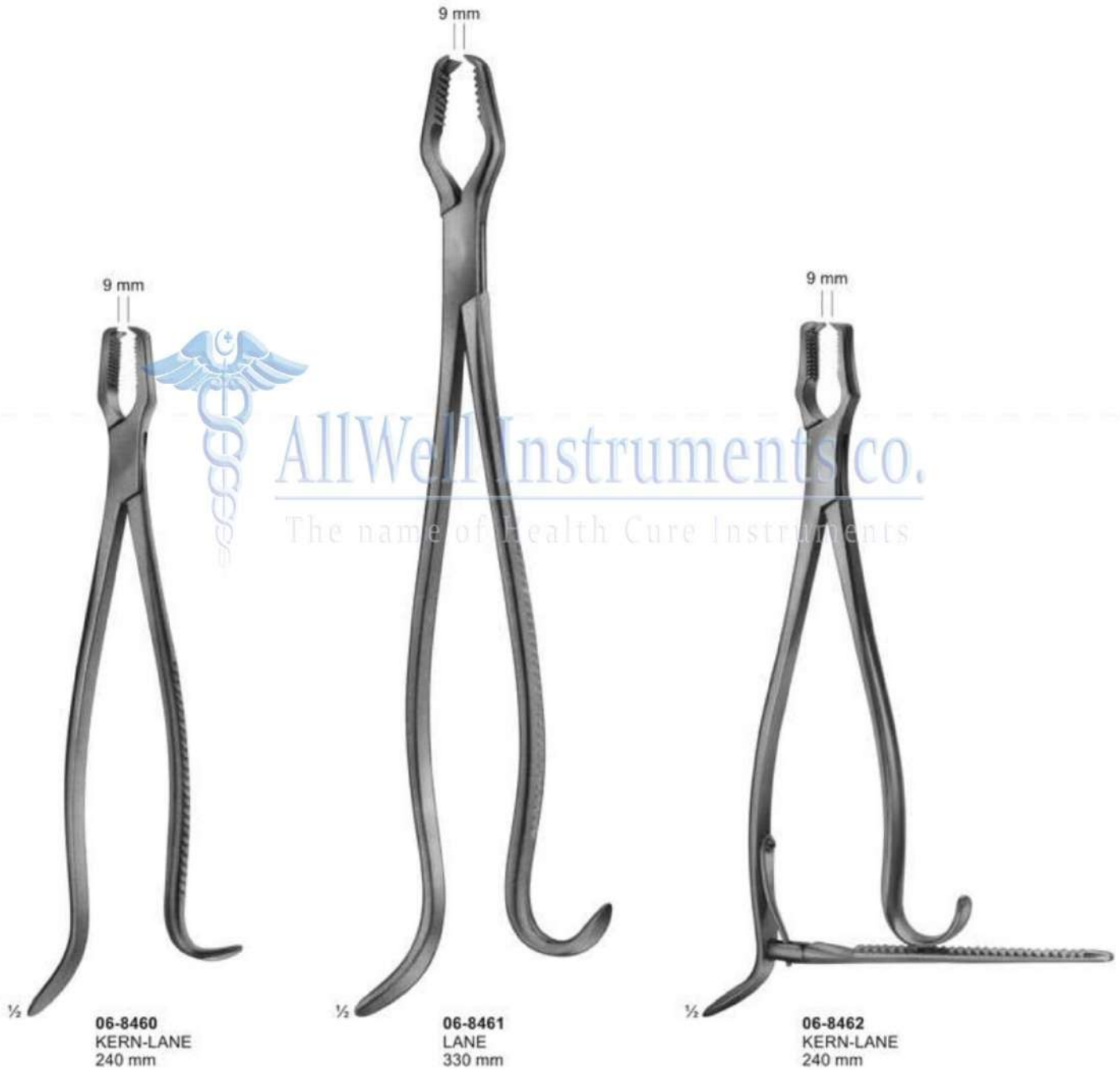

## Bone Holding Forceps



 AllWell Instruments co.  
The name of Health Care Instruments



# Bone Holding Forceps

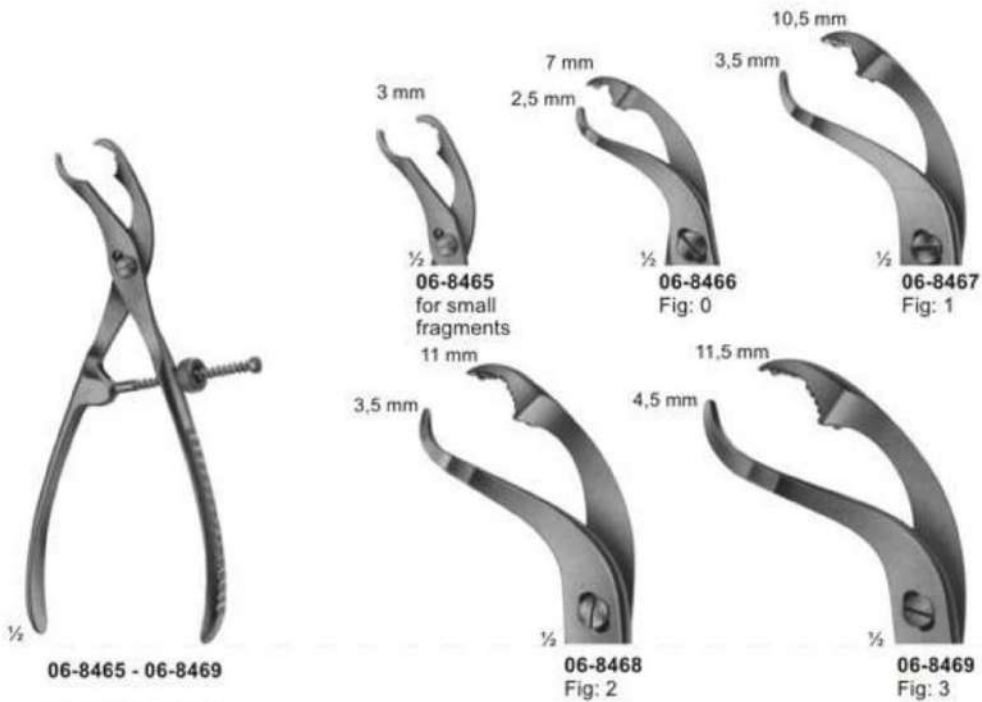

06-8465 - 06-8469

- 06-8465 145 mm
- 06-8466 190 mm
- 06-8467 240 mm
- 06-8468 260 mm
- 06-8469 280 mm

Self-centering forceps  
with thread fixation

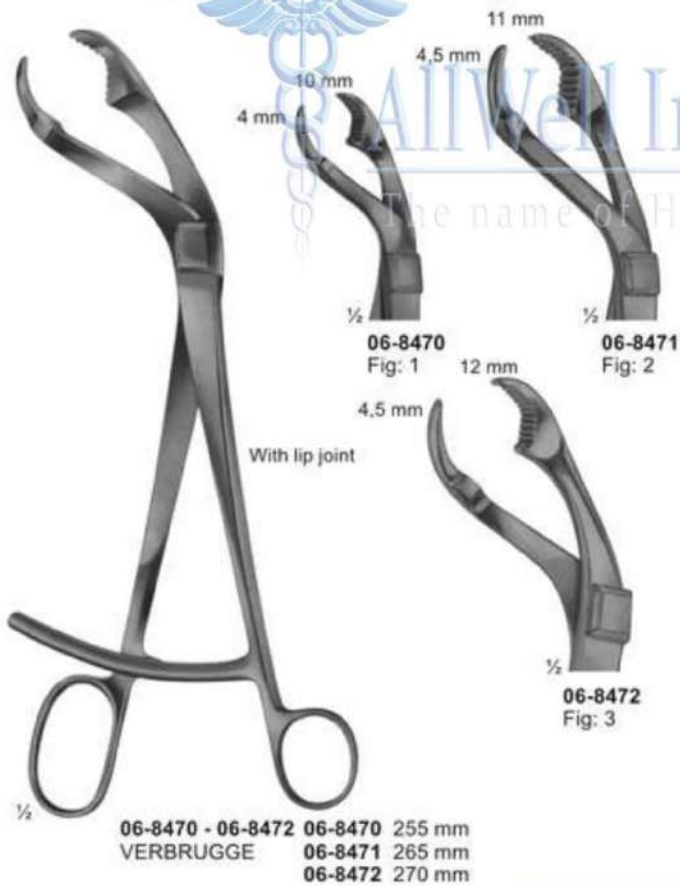

06-8470 - 06-8472  
VERBRUGGE

- 06-8470 255 mm
- 06-8471 265 mm
- 06-8472 270 mm

With lip joint



06-8473  
LAMBOTTE  
265 mm

## Bone Clamps



1/2

**06-8474 - 06-8475**  
**LOWMAN**  
**06-8474 170 mm**  
**06-8475 205 mm**



1/2

**06-8476**  
**LOWMAN-GERSTER**  
**210 mm**



1/2

**06-8477**  
**LOWMAN-HOGLUND**  
**175 mm**



**AllWell Instruments co.**  
The name of Health Cure Instruments

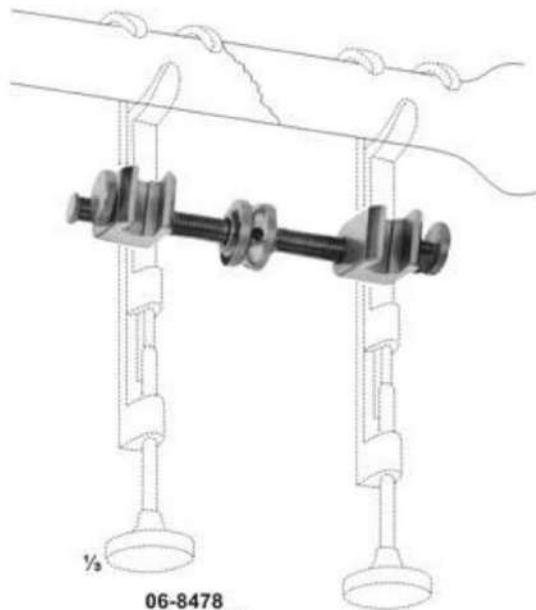

1/2

**06-8478**  
**GERSTER**  
Traction bar for **06-8474 - 06-8477**

# Synovectomy-Rongeurs, Bone Rongeurs



06-8479 06-8480

**06-8479 - 06-8480**  
Synovectomy rongeur  
width of jaws 1.2 mm  
130 mm



06-8481 06-8482

**06-8481 - 06-8482**  
Synovectomy rongeur  
width of jaws 2.0 mm  
130 mm



**06-8483**  
**STELLBRINK**  
Synovectomy rongeur  
175 mm



**AllWell Instruments co.**  
The name of Health Cure Instruments



**06-8484**  
**STELLBRINK**  
Synovectomy rongeur  
170 mm



**06-8485**  
**LUER-FRIEDMANN**  
145 mm



**06-8486**  
140 mm



# Bone Rongeurs



**06-8487**  
LUER  
150 mm



**06-8488**  
LUER  
155 mm



**06-8489**  
BLUMENTHAL  
155 mm



**AllWell Instruments co.**  
The name of Health Care Instruments



**06-8490**  
BLUMENTHAL  
150 mm



**06-8491 - 06-8492**  
JANSEN  
175 mm

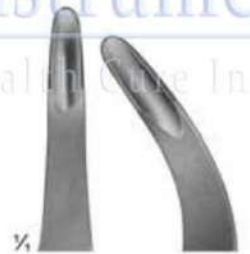

**06-8491**

**06-8492**



**06-8493**  
BANE-HARTMANN  
175 mm

# Bone Rongeurs



**06-8494**  
**ALEXANDER**  
140 mm



**06-8495**  
**JANSEN**  
190 mm

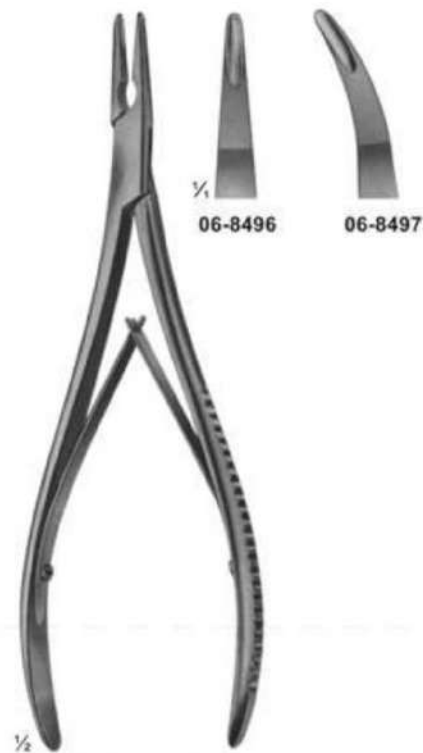

**06-8496 - 06-8497**  
**LEMPERT**  
200 mm



**AllWell Instruments co.**  
The name of Health Cure Instruments

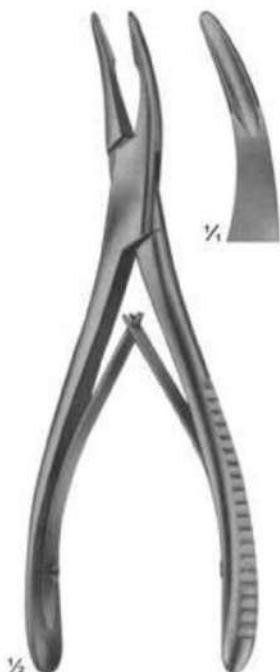

**06-8498**  
**BEYER**  
180 mm



**06-8499**  
**MEAD**  
165 mm



**06-8500**  
**MEAD**  
165 mm

# Bone Rongeurs

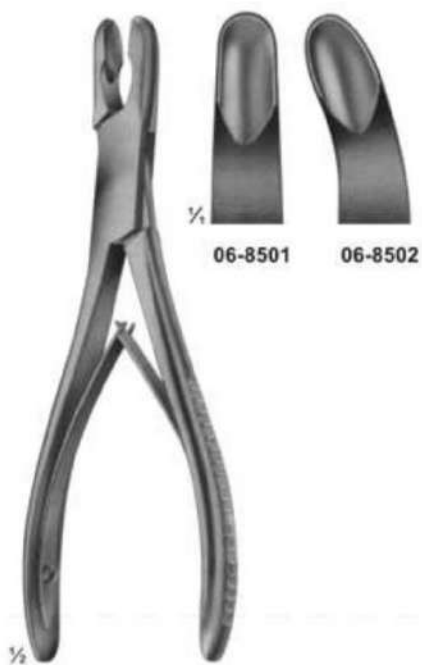

06-8501    06-8502

06-8501 - 06-8502  
LUER  
175 mm



06-8503  
LUER  
180 mm



06-8504  
LUER  
180 mm



**AllWell Instruments co.**

The name of Health Cure Instruments



06-8505  
OLIVECRONA  
205 mm



06-8506 - 06-8507  
BOHLER  
155 mm



06-8508  
MARQUARDT  
200 mm



# Bone Rongeurs

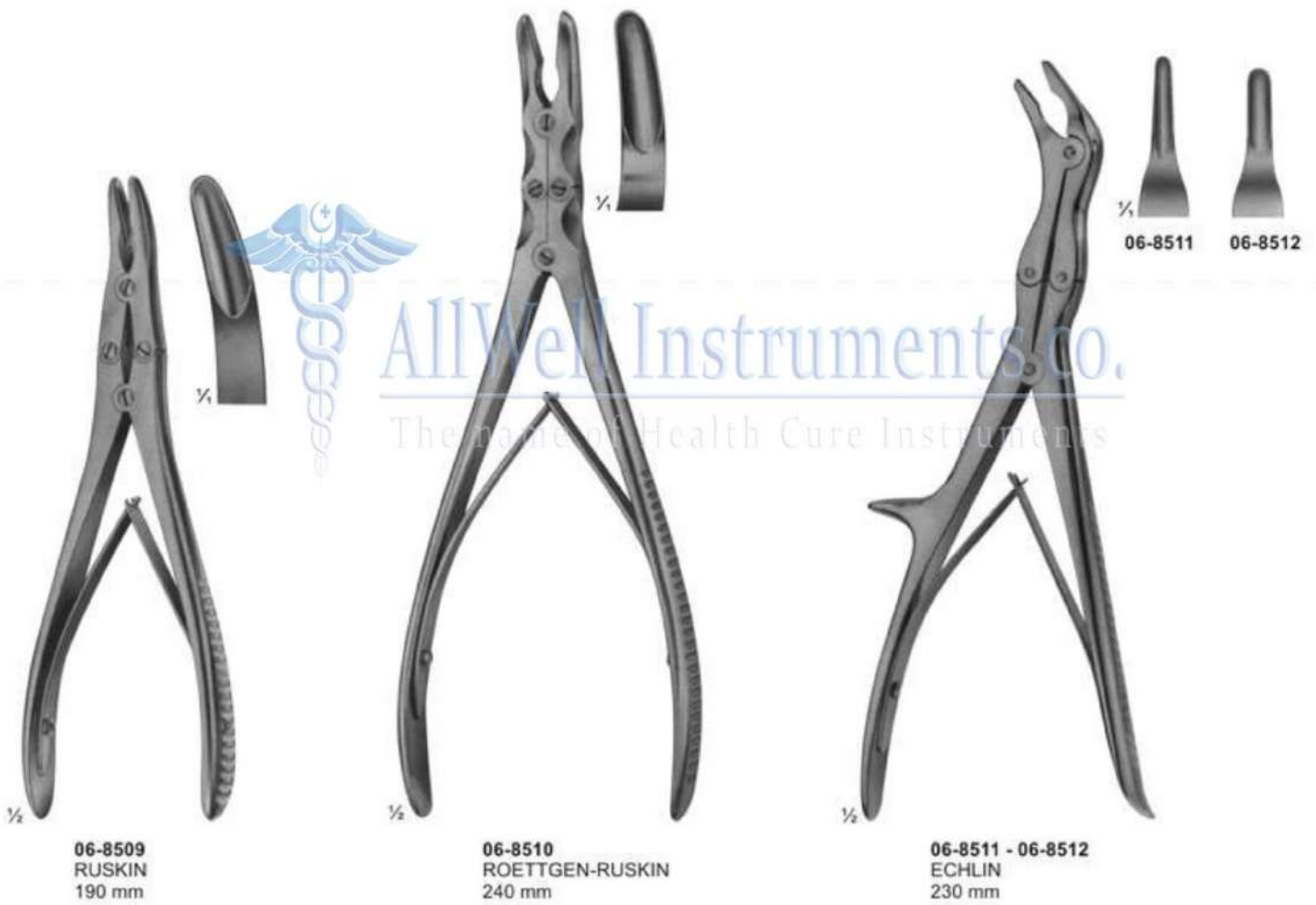

## Bone Rongeurs



06-8513  
STILLE  
235 mm



06-8514  
LEKSELL-STILLE  
240mm



06-8515  
STILLE-RUSKIN  
240mm

## Bone Rongeurs



**06-8516**  
LUER-STILLE  
225 mm



**06-8517**  
LUER-STILLE  
225 mm

AllWell Instruments co.  
The name of Health Care Instruments



## Bone Rongeurs



06-8518  
LUER-STILLE  
270 mm



06-8519  
SEMB  
240 mm

# Bone Cutting Forceps



**06-8520**  
STAMM  
150 mm



**06-8521**  
KAZANJIAN  
185 mm



**AllWell Instruments co.**

The name of Health Cure Instruments



**06-8522 - 06-8525**  
LISTON

**06-8522**  
140 mm

**06-8523**  
170 mm



**06-8524**  
200 mm



**06-8525**  
220 mm



**06-8526 - 06-8528**  
LISTON

**06-8526**  
170 mm

**06-8527**  
200 mm

**06-8528**  
220 mm

## Bone Cutting Forceps



**06-8529**  
BOEHLER  
145 mm



**06-8530**  
RUSKIN-LISTON  
190 mm



**06-8531**  
RUSKIN-LISTON  
190 mm





## Bone Cutting Forceps

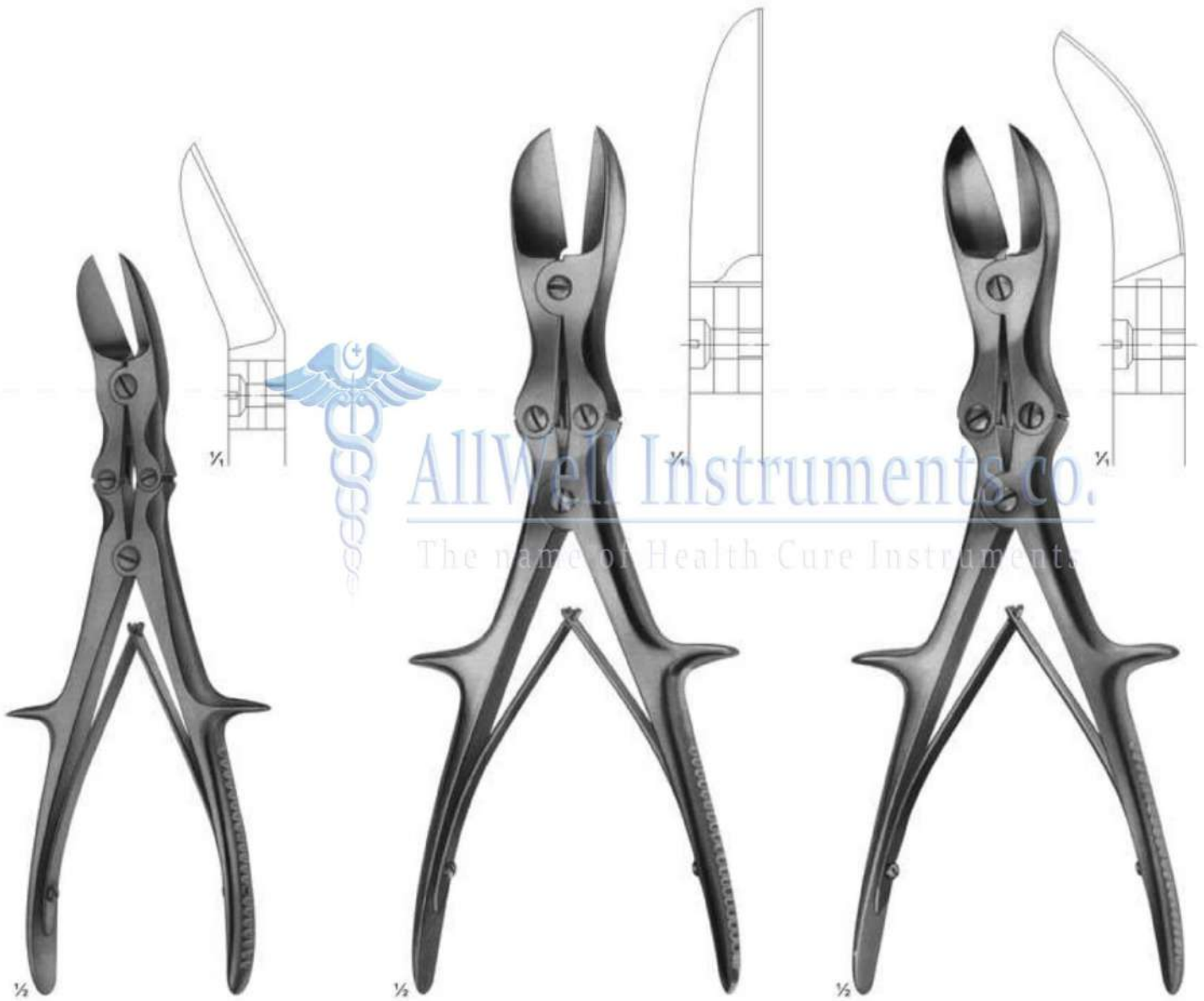

**06-8532**  
LISTON  
curved on flat  
240 mm

**06-8533**  
LISTON  
straight  
280 mm

**06-8534**  
LISTON  
curved on flat  
280 mm

## Bone Cutting Forceps

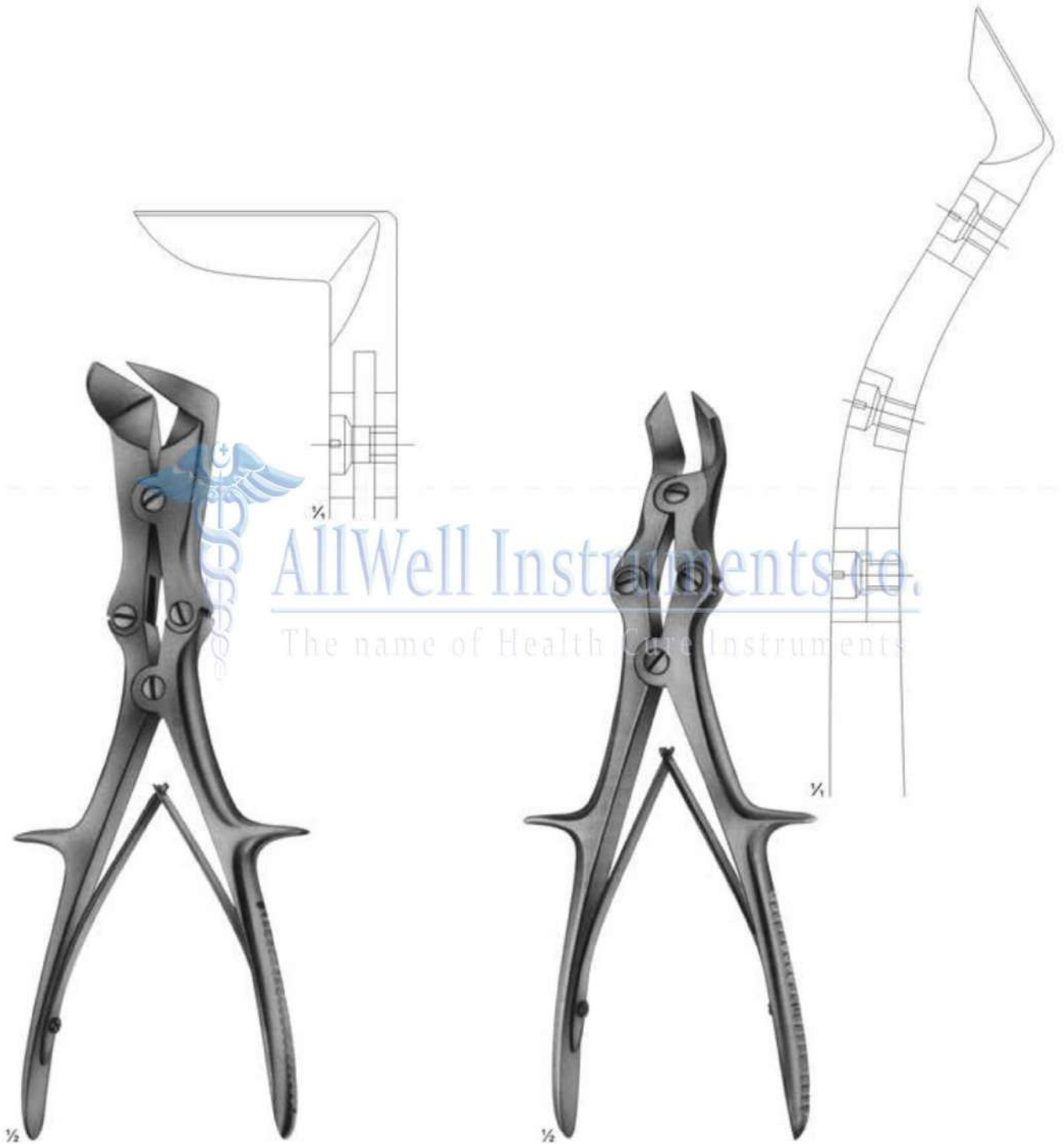

**06-8535**  
LISTON-STILLE  
265 mm

**06-8536**  
LISTON-KEY-HORSLEY  
(TUDOR EDWARDS)  
255 mm

## Meniscus-and Cartilage Forceps



06-8537  
BIRCHER  
200 mm



06-8538  
BIRCHER  
200 mm



06-8539  
WELLER  
200 mm

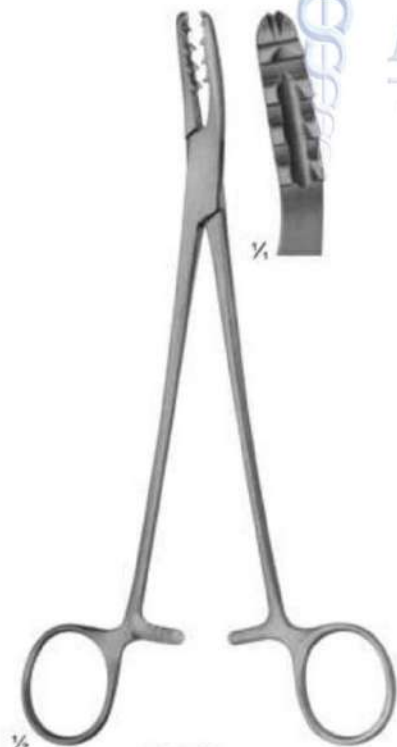

06-8540  
BIRCHER-GANSKE  
200 mm



06-8541  
BIRCHER-GANSKE  
200 mm



06-8542  
MARTIN  
205 mm

**AllWell Instruments co.**  
The name of Health Care Instruments



# Meniscus Knives



# Meniscus Knives

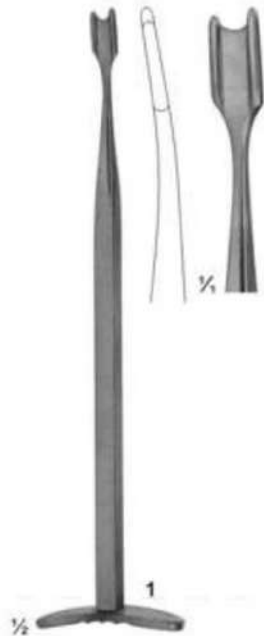

**06-8547**  
**SMILLIE**  
170 mm

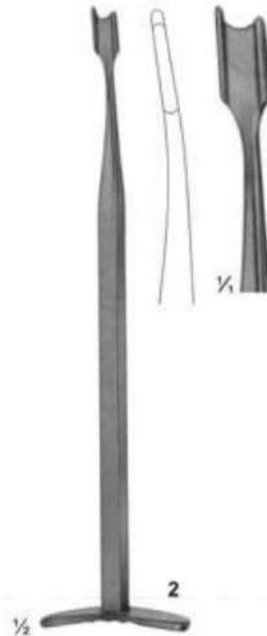

**06-8548**  
**SMILLIE**  
170 mm

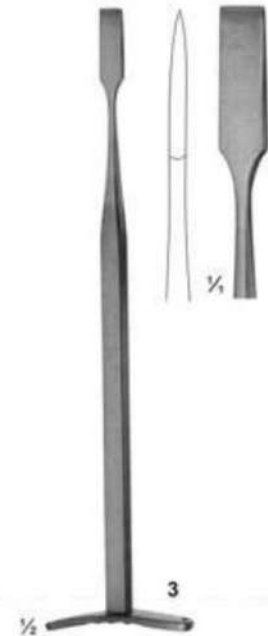

**06-8549**  
**SMILLIE**  
170 mm

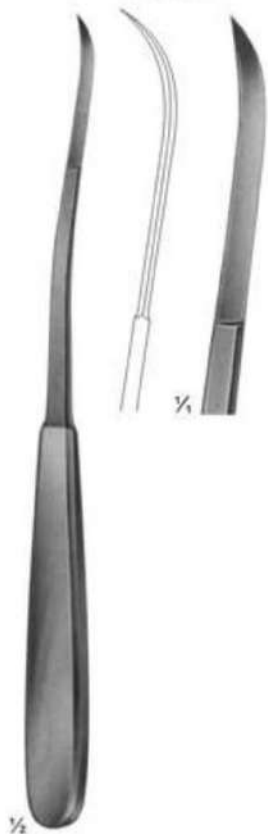

**06-8550**  
**SALENIUS**  
220 mm



**06-8551**  
**SALENIUS**  
220 mm



**06-8552**  
**CANAD. MODELL**  
200 mm

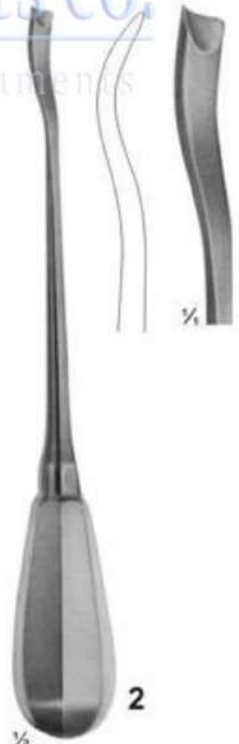

**06-8553**  
**CANAD. MODELL**  
200 mm

# Wire Extension

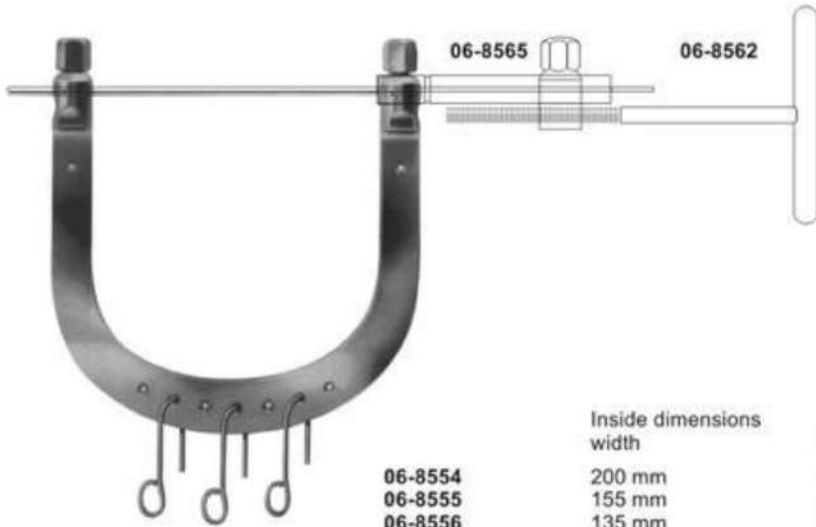

**06-8554 - 06-8560**  
**KIRSCHNER**  
Wire traction bows,  
to be used with  
KIRSCHNER-wires  
up to 2.5 mm diam.,  
With 3 hooks,  
stainless steel

	Inside dimensions width	depth	
<b>06-8554</b>	200 mm	155 mm	for the hip
<b>06-8555</b>	155 mm	155 mm	for the femur
<b>06-8556</b>	135 mm	130 mm	for the knee
<b>06-8557</b>	120 mm	120 mm	for the knee
<b>06-8558</b>	105 mm	100 mm	for the knee
<b>06-8559</b>	95 mm	110 mm	for the calcaneus
<b>06-8560</b>	95 mm	70 mm	for the arm and elbow



**06-8561**  
Wrench, double - ended,  
for wire traction bows

**AllWell Instruments co.**  
The name of Health Care Instruments



**06-8562**  
Wire tightener, with  
clamping jaws



**06-8563**  
Traction hook only,  
large size



**06-8564**  
Traction hook only,  
small size



**06-8565**  
Fixation clamp, to secure clamping  
jaws of **06-8562** stainless steel



# Wire Extension

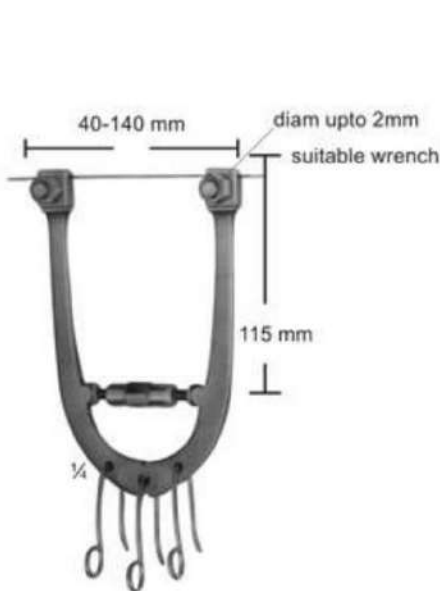

**06-8566**  
Wire traction bow, adjustable, with 3 hooks, small size

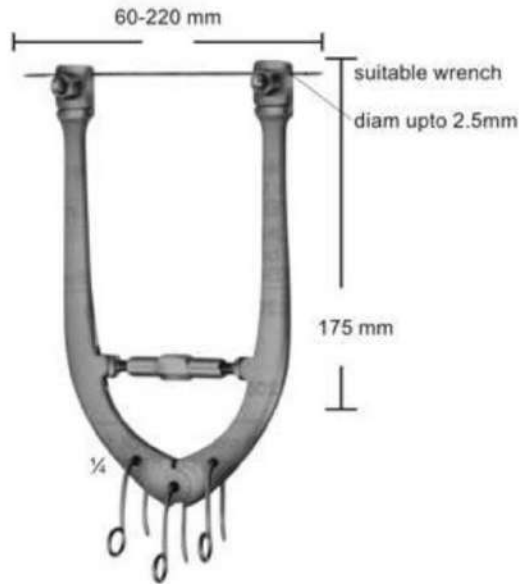

**06-8567**  
Wire traction bow, adjustable, with 3 hooks, large size

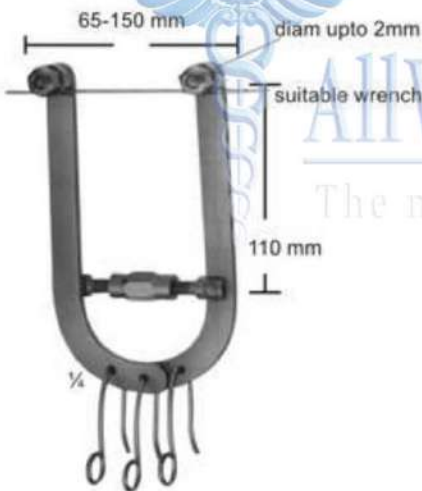

**06-8568**  
Wire traction bow, adjustable, with 3 hooks, small size for elbow and calcaneus, for adolescents



**American Type**

<b>06-8569</b>	max. 105 mm
<b>06-8570</b>	max. 160 mm
<b>06-8571</b>	max. 200 mm
<b>06-8569</b>	80-95 mm
<b>06-8570</b>	90-120 mm
<b>06-8571</b>	140-170 mm
diam upto	
<b>06-8569</b>	1,6 mm
<b>06-8570</b>	2,0 mm
<b>06-8571</b>	2,5 mm

**06-8569 - 06-8571**  
**KIRSCHNER**  
Wire traction bows, modified, adjustable in width, holds wire securely, with 1 hook



**06-8572**  
Fixation disc, slotted



**06-8574**  
Fixation disc, slotted



**06-8573**  
idem, aluminum, transparent to X-rays



**06-8575**  
Screw driver, for above fixations discs

## Traction Bows, Distractor



Boehler traction bows, to be used with STEINMANN pins, 4mm diam

Boehler traction bows, to be used with STEINMANN pins, 5mm diam

	Inside width	For
06-8576 with pin (09-8588)	16x9cm	Arm
06-8577 without pin		
06-8578 with pin (09-8590)	21x11cm	Femur and knee
06-8579 without pin		
06-8580 with pin (09-8592)	21x15cm	Femur and knee
06-8581 without pin		



**06-8584 - 06-8598**  
STEINMANN  
triangular shaft ended and trocar point

diam $\varnothing$	4,0 mm	5,0 mm
Length		
80 mm	<b>06-8584</b>	
100 mm	<b>06-8585</b>	
120 mm	<b>06-8586</b>	
140 mm	<b>06-8587</b>	
150 mm	<b>06-8588</b>	<b>06-8594</b>
160 mm	<b>06-8589</b>	
180 mm	<b>06-8590</b>	<b>06-8595</b>
200 mm	<b>06-8591</b>	<b>06-8596</b>
210 mm	<b>06-8592</b>	
250 mm	<b>06-8593</b>	<b>06-8597</b>
300 mm		<b>06-8598</b>



**06-8599**  
SCHWARZ  
Traction bow for fingers,  
to be used with KIRSCHNER-  
wire up to 1.6 mm diam.



**06-8600**  
Small distractor  
as a repositioning device for  
distraction and compression of small bones,  
for wires with 3.0 mm diam.



**06-8601**  
Protection cap  
for 4,0 mm STEINMANN Pins



**06-8602**  
Protection cap  
for 5,0 mm STEINMANN Pins

## Drilling Chucks and Cerclage Wire Tightener



**06-8603**  
REILL  
Drilling chuck, cannulated, for shanks from 2.0 - 2.5 mm diam 115 mm



**06-8604**  
Drilling chuck, cannulated, for shanks from 0.8 - 2.0 mm diam 150 mm



**06-8605**  
Drilling chuck, cannulated, for shanks up to 4.5 mm diam with key 140 mm



**06-8606**  
LOUTE  
Wire tightener, improved pattern, with movable tip, for wires up to 1.0 mm diam. 220 mm

Movable tip made of (material used for implants). While twisting the movable head remains stable, therefore the wire will not slip off.



AllWell Instruments Co.

The name of Health Care Instruments

Chuck jaws made of material used for implants



**06-8607**  
Drilling chuck, cannulated, for shanks up to 6.35 mm diam., To be tightened by hand 100 mm



**06-8608**  
Drilling chuck, cannulated, for shanks up to 4.5 mm diam., And for triangular shaft width across flats 4.7 mm (schanz screws, steinmann pins). with key **06-8609**



**06-8610**  
Drilling chuck, cannulated, for shanks up to 6.35 mm diam., With key **06-8611** 160 mm



# Cerclage Instruments

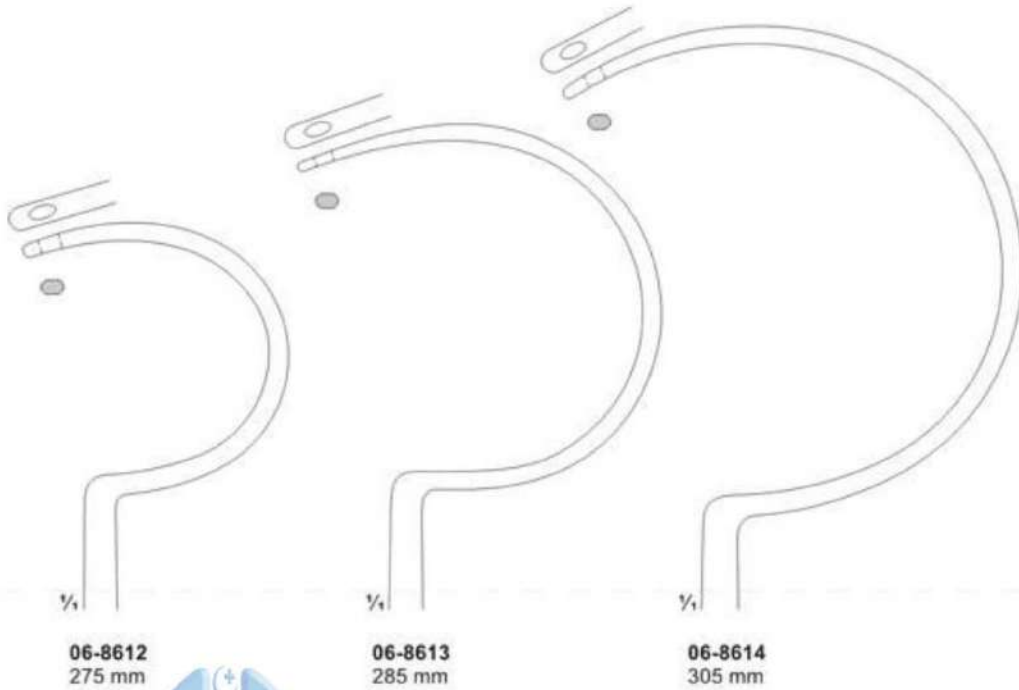

06-8612 - 06-8614  
DEMEL  
Wire guides

**AllWell Instruments co.**  
The name of Health Care Instruments



# JORDAN instruments for subcutaneous Tibia Cerclage

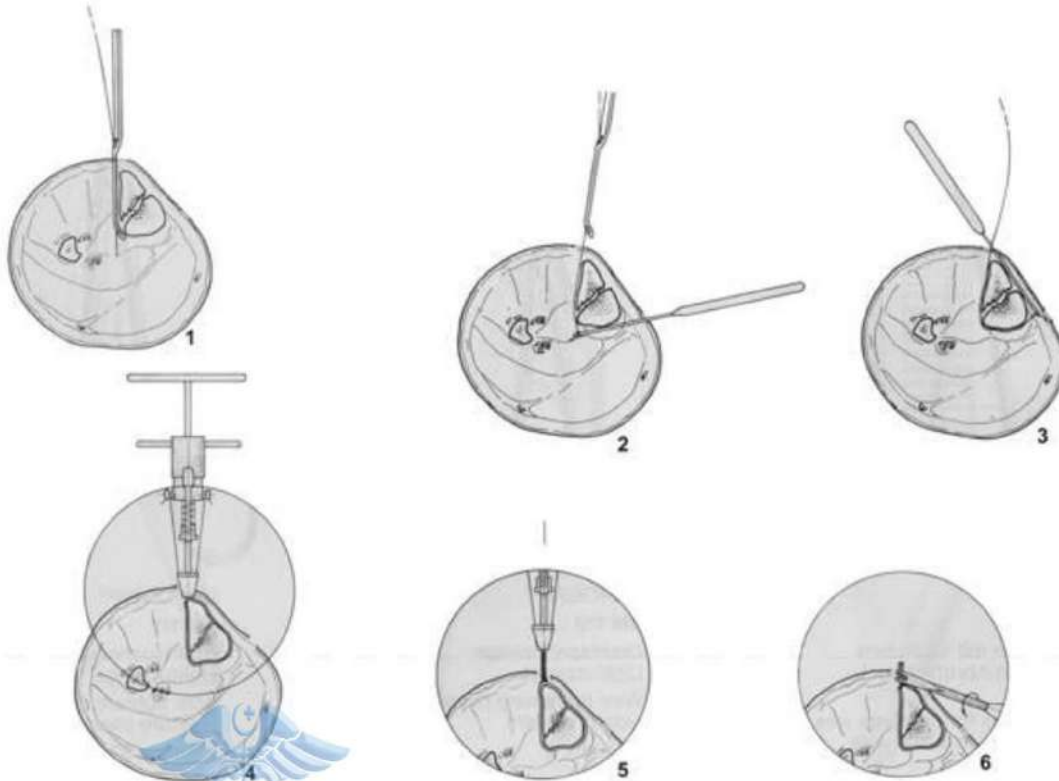

**AllWell Instruments co.**

The name of Health Cure Instrument



**06-8618**  
JORDAN  
Wire tightener



**06-8619**  
JORDAN  
Wire twister  
170 mm



**06-8620**  
JORDAN  
Wire catcher  
180 mm



**06-8621**  
JORDAN  
Probe, cannulated  
170 mm

# Wire Holding forceps, Wire Tightening Pliers, Flat-nosed Pliers DUROGRIP with Hard Metal Inserts



**06-8622**  
DUROGRIP  
Holding forceps for cerclage wire, with lateral jaws to avoid wire slipping off  
170 mm



**06-8623**  
DUROGRIP  
Wire, tightening pliers, Ligature pliers  
150 mm



**06-8624**  
DUROGRIP  
Wire, tightening pliers, Ligature pliers  
150 mm

**AllWell Instruments Co.**  
The name of Health Cure Instruments



**06-8625**  
with serrated jaws  
140 mm



**06-8626**  
one jaw smooth, one jaw serrated  
140 mm



**06-8627**  
with serrated jaws  
**06-8628**  
with longitudinal and transversal grooves  
170 mm



**06-8629**  
190 mm



# Wire Holding forceps, Flat-nosed Pliers, Pliers for bending and cutting wires



**06-8630**  
130 mm

**06-8631**  
180 mm



**06-8630 - 06-8631**  
Extraction pliers  
for boring wires

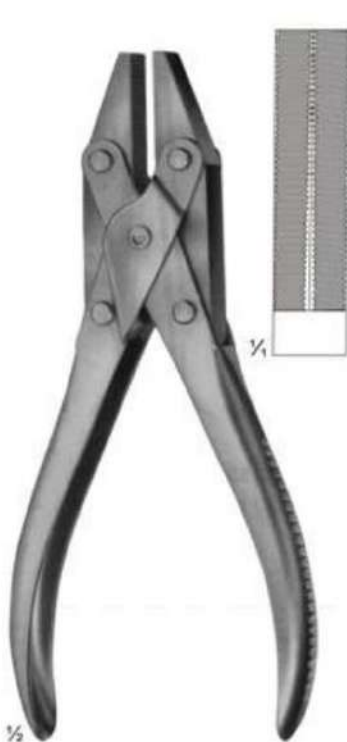

**06-8632**  
Flat-nosed pliers,  
parallel  
185 mm

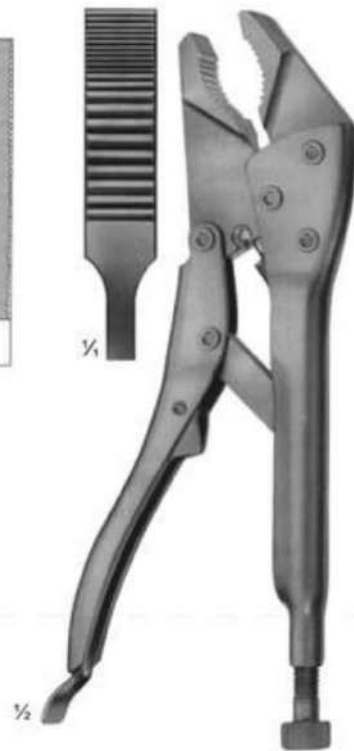

**06-8633**  
Vise grip  
200 mm

**AllWell Instruments co.**

The name of Health Cure Instruments



**06-8634**  
Round Pliers  
180mm



**06-8634**



**06-8634**



**06-8635**



**06-8636**



**06-8637**

**06-8635** 145 mm  
**06-8636** 180 mm  
**06-8637** 180 mm  
Extraction pliers for wires



**06-8638**  
Bending pliers  
for wires up to  
1.8 mm diam.

# Wire Cutters and wire Cutting Scissors DUROTIP with Carbide Cutting Edges



**06-8639**  
ANGLE  
130 mm

for soft wire  
up to diam.  
for hard wire  
up to diam.

0,5 mm  
0,3 mm

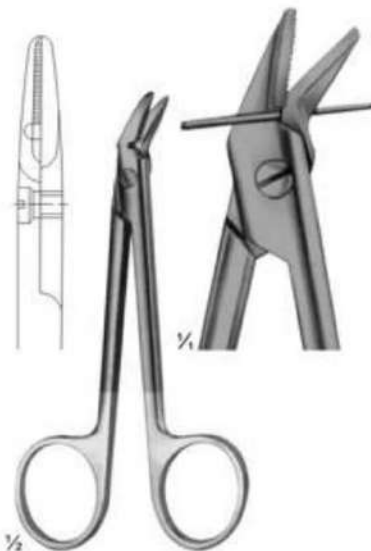

**06-8641**  
120 mm

for soft wire  
up to diam.  
for hard wire  
up to diam.

1,2 mm  
0,8 mm

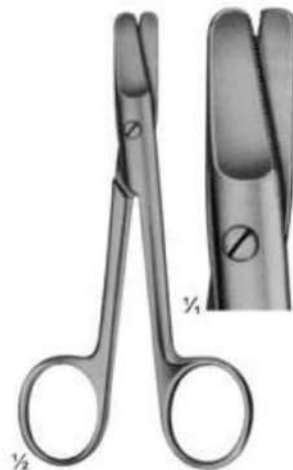

**06-8643**  
HARVEY  
125 mm

0,4 mm  
0,3 mm



**06-8644**  
150 mm

for soft wire  
up to diam  
for hard wire  
up to diam

1,5 mm  
1,0 mm



**06-8645**  
160 mm

1,5 mm  
1,2 mm



**06-8646**  
140 mm  
DUROTIP  
1,5 mm

1,0 mm

**AllWell Instruments co.**  
The name of Health Cure Instruments

## Wire Cutting Pliers, Lateral Cutting Action



1/2

**06-8647**  
180 mm

for soft wire  
up to diam. 2,0 mm  
For hard wire 1,5 mm  
up to diam  
specially hardened  
cutting edges, front  
and lateral cutting  
action



1/2

**06-8648**  
REILL  
175 mm

for soft wire  
up to diam. 2,0 mm  
For hard wire 1,6 mm  
up to diam  
specially hardened  
cutting edges, for  
cutting off wires close  
to the bone



1/2

**DUROTIP**  
**06-8649**  
235 mm

for soft wire  
up to diam. 3,0 mm  
For hard wire 2,2 mm  
up to diam



# Wire Cutting Pliers, Lateral and Front Cutting Action



specially hardened cutting edges

1/2

**06-8650**  
240 mm

for soft wire up to diam. 2,0 mm  
For hard wire up to diam 1,6 mm



1/4

Durotip

1/2

**06-8651**  
145 mm

for soft wire up to diam. 1,5 mm  
For hard wire up to diam 1,0 mm



1/4

Durotip

1/2

**06-8652**  
145 mm

for soft wire up to diam. 2,0 mm  
For hard wire up to diam 1,5 mm



1/4

Durotip

1/2

**06-8653**  
220 mm

for soft wire up to diam. 3,5 mm  
For hard wire up to diam 2,5 mm

## Wire Cutting Pliers



AllWell Instruments co.  
The name of Health Care Instruments



**06-8654**  
320 mm

for soft wire  
up to diam. 3,0 mm  
For hard wire  
up to diam 3,0 mm



Cutter for cutting off  
KIRSCHNER wires,  
Tibia head screws,  
bolts, pins, up to 3 mm diam.



**DUROTIP**

**06-8655**  
Cutter for cutting off  
KIRSCHNER wires,  
Tibia head screws,  
bolts, pins, up to 6 mm diam.  
470 mm

# Finger Nail Instruments

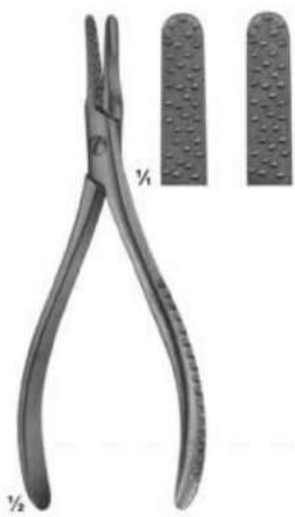

**06-8656**  
Nail extracting  
forceps  
135 mm



**06-8657**  
Nail extracting  
forceps  
145 mm



**06-8658**  
Finger nail drill  
with 3 drill points



**AllWell Instruments co.**  
The name of Health Care Instruments

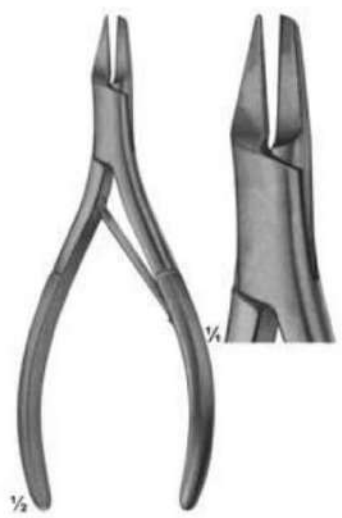

**06-8662**  
Nail splitting  
forceps  
135 mm



**06-8663**  
SYSTRUNK  
Scissors, for splitting  
finger nails  
130 mm



**06-8664**  
Finger ring saw  
150 mm



# Section - 07



AllWell Instruments Co.  
The name of Health Care Instruments



**Pages 393-432**

- ★ Plaster instruments
- ★ Suction instruments
- ★ Tungsten carbide Inserts
- ★ Hospital wares

# Plaster Instruments

## Plaster Knives



with ebony handle

07-9001  
HOPKINS  
200 mm



07-9002  
ESMARCH  
180 mm

## Plaster Saw



07-9003  
ENGEL  
160 mm



AllWell Instruments co.

The name of Health Cure Instruments

## Bandage and First-Aid scissors



1/2

07-9004 - 07-9012 145mm

07-9004	black	07-9008	yellow
07-9005	red	07-9009	white
07-9006	blue	07-9010	orange
07-9007	light green	07-9011	violet
		07-9012	bright pink



1/2

07-9013 - 07-9021 180mm

07-9013	black	07-9017	yellow
07-9014	red	07-9018	white
07-9015	blue	07-9019	orange
07-9016	light green	07-9020	violet
		07-9021	bright pink



# Plaster Scissors

For small plaster dressings



**07-9022**  
160 mm

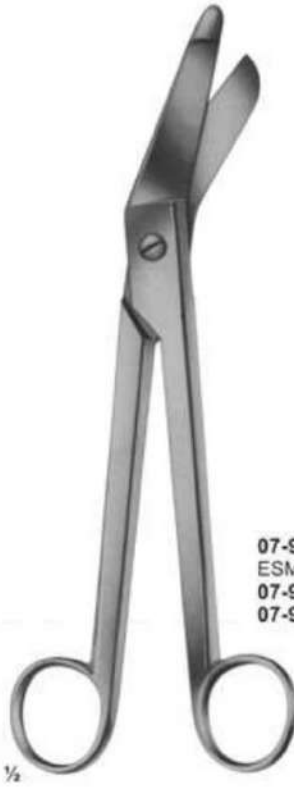

**07-9023 - 07-9024**  
ESMARCH  
07-9023 200mm  
07-9024 230mm



**07-9025**  
BERGMANN  
230 mm



**07-9026**  
BRUNS  
235 mm



**07-9027**  
235 mm



**07-9028**  
SEUTIN  
230 mm

also to be used as  
bandage scissors

also to be used as  
bandage scissors

 **AllWell Instruments co.**  
The name of Health Cure Instruments



# Plaster Shears

**Special features:**

The construction of the open jaws avoids tiresome clogging by plaster remnants and allows furthermore an easy cleaning.  
 The shears do not glide off the plaster owing to the deep teething on the jaws.  
 The knives with hollow grinding have a better cutting ability and therefore less force is required.  
 The knives are guided by ball bearings.

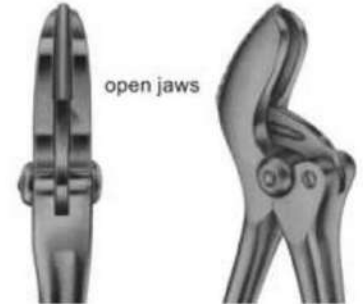

**07-9029A**  
 Spare blade

**07-9029**  
 STILLE  
 260 mm



**07-9031**  
 Spare blade

**07-9030**  
 STILLE  
 360 mm

AllWell Instruments co.  
 The name of Health Cure Instruments

## STILLE Plaster Shears

Blade with reinforced back



**07-9032**  
STILLE  
230 mm

**07-9033**  
Spare blade



**07-9034**  
STILLE  
370 mm

**07-9035**  
Spare blade



**07-9036**  
STILLE  
240 mm

**07-9037**  
Spare blade

# Plaster Spreader, Plaster Breakers



**07-9038**  
**HENNIG**  
 270 mm

**07-9039**  
**MOD.USA**  
 230 mm

**07-9040**  
 290 mm

**07-9041 - 07-9042**  
**WOLFF**  
**07-9041** 180 mm  
**07-9042** 240 mm  
 plaster breakers



# Vacuum Currettes for Aspiration Lipectomy, Suction Instuments

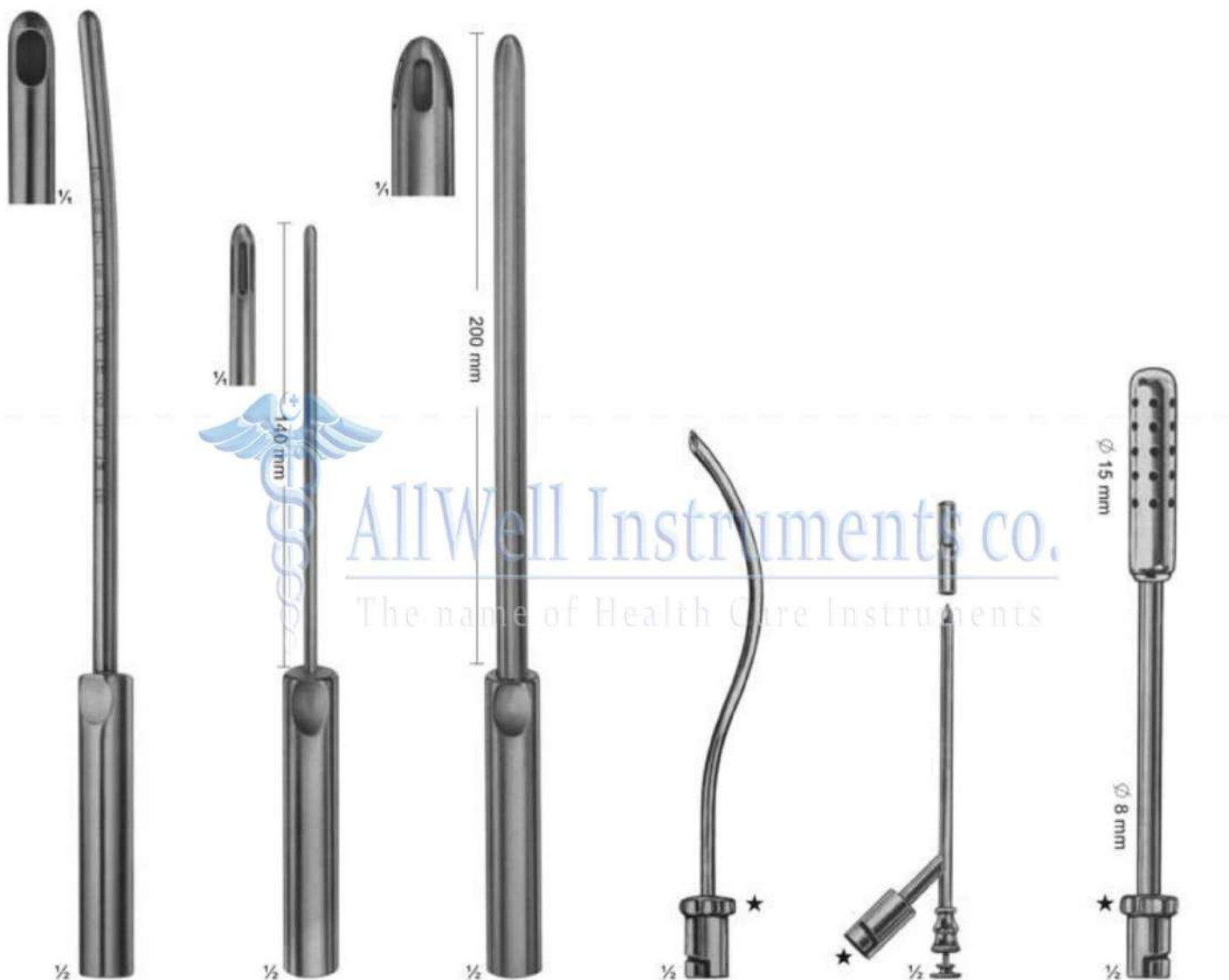

**07-9043 - 07-9048**  
BIEMER

- 07-9043 ∅ 4mm
- 07-9044 ∅ 6mm
- 07-9045 ∅ 8mm
- 07-9046 ∅ 10mm
- 07-9047 ∅ 12mm
- 07-9048 ∅ 14mm

Currettes for aspiration lipectomy, graduated, slightly curved

**07-9049 - 07-9050**  
BIEMER

- 07-9049 ∅ 4 mm
  - 07-9050 ∅ 6 mm
- Currettes for aspiration lipectomy, with three apertures, slightly curved malleable

**07-9051 - 07-9053**  
BIEMER

- 07-9051 ∅ 8 mm
  - 07-9052 ∅ 10 mm
  - 07-9053 ∅ 12 mm
- Currettes for aspiration lipectomy, with three apertures, slightly curved malleable

**07-9054**  
For aspirating fluid from the excretory ducts of large glands and for keeping the operating area clear 170 mm

**07-9055**  
Trocar  
For puncturing 150 mm

**07-9056**  
For clearing large quantities of fluid 190 mm

## Suction Instruments

**07-9057** 150mm  
Suction handle, with vacuum regulator and finger cut-off, brass, mirror-finish chromium-plated



olive  
Ø 9 mm

**07-9058** 170mm  
Suction handle, with hand regulation valve and quick-shutter, brass, mirror-finish chromium-plated



★ Both suction handles have bayonet fitting olive and can be used for the suction cannulae. Ø 9 mm



AllWell Instruments co.  
The name of Health Care Instruments



**07-9059**  
Trocar  
For puncturing  
170 mm



**07-9060**  
Hollow needle,  
sharp  
150 mm



**07-9061**  
double curved  
For general  
surgery  
230 mm



**07-9062**  
For tonsillectomy,  
oral and laryngeal  
operations  
190 mm



**07-9063**  
For tonsillectomy,  
oral and laryngeal  
operations  
220 mm

★ With bayonet fitting to be used with suction handles (07-9057 - 07-9058)

# Suction Instruments

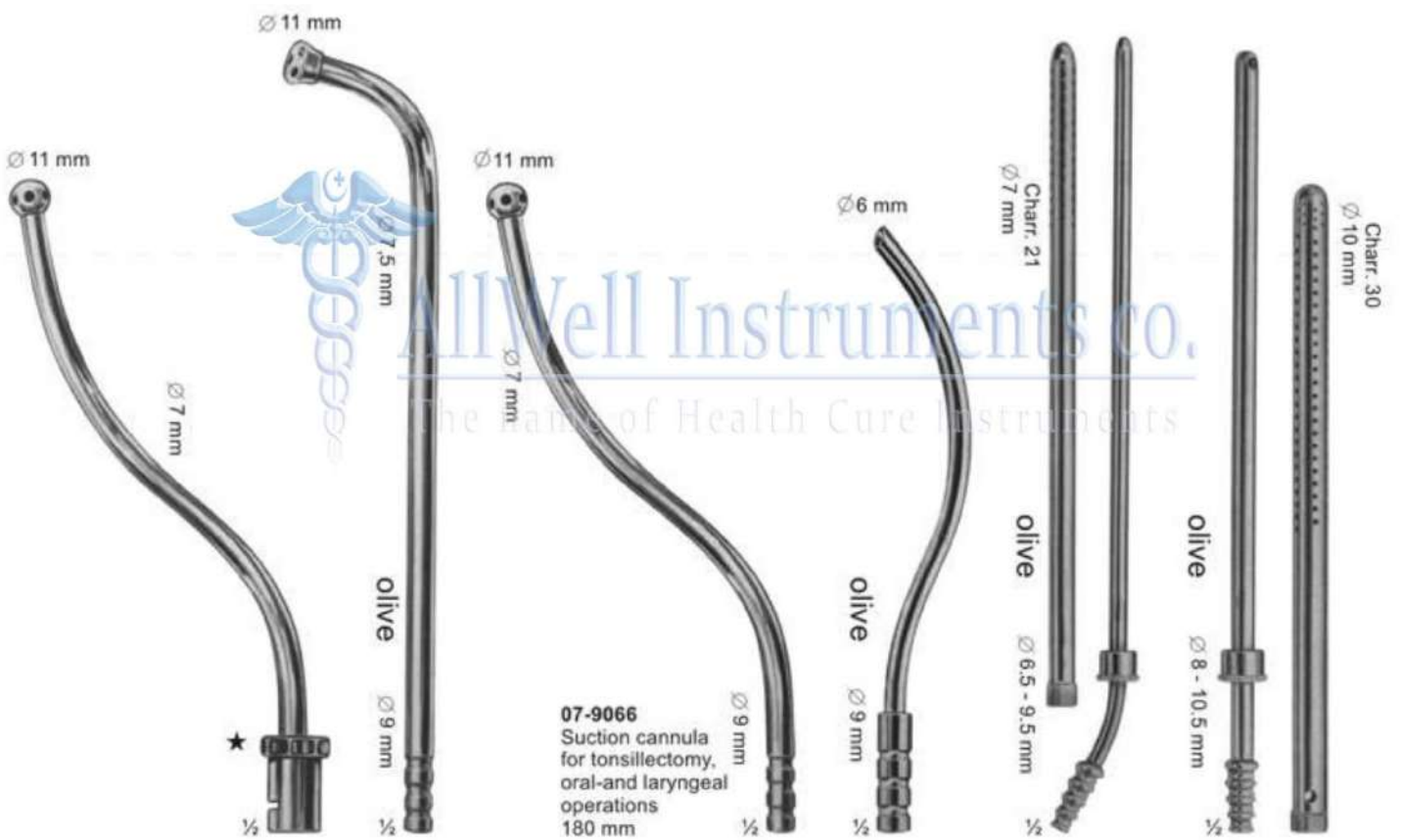

**07-9064**  
 For tonsillectomy, oral-and laryngeal operations  
 180 mm

**07-9065**  
 Suction cannula for tonsillectomy, oral-and laryngeal operations  
 220 mm

**07-9066**  
 Suction cannula for tonsillectomy, oral-and laryngeal operations  
 180 mm

**07-9067**  
 S-shaped blunt cannula for aspirating fluid from the excretory ducts of large glands and for keeping the operating area clear  
 170 mm

**07-9068**  
 POOL Suction cannula, with outer tube to be screwed of  
 225 mm

**07-9069**  
 POOL Suction cannula, with outer tube to be screwed off  
 225 mm



# Suction Instruments



# Suction Instruments

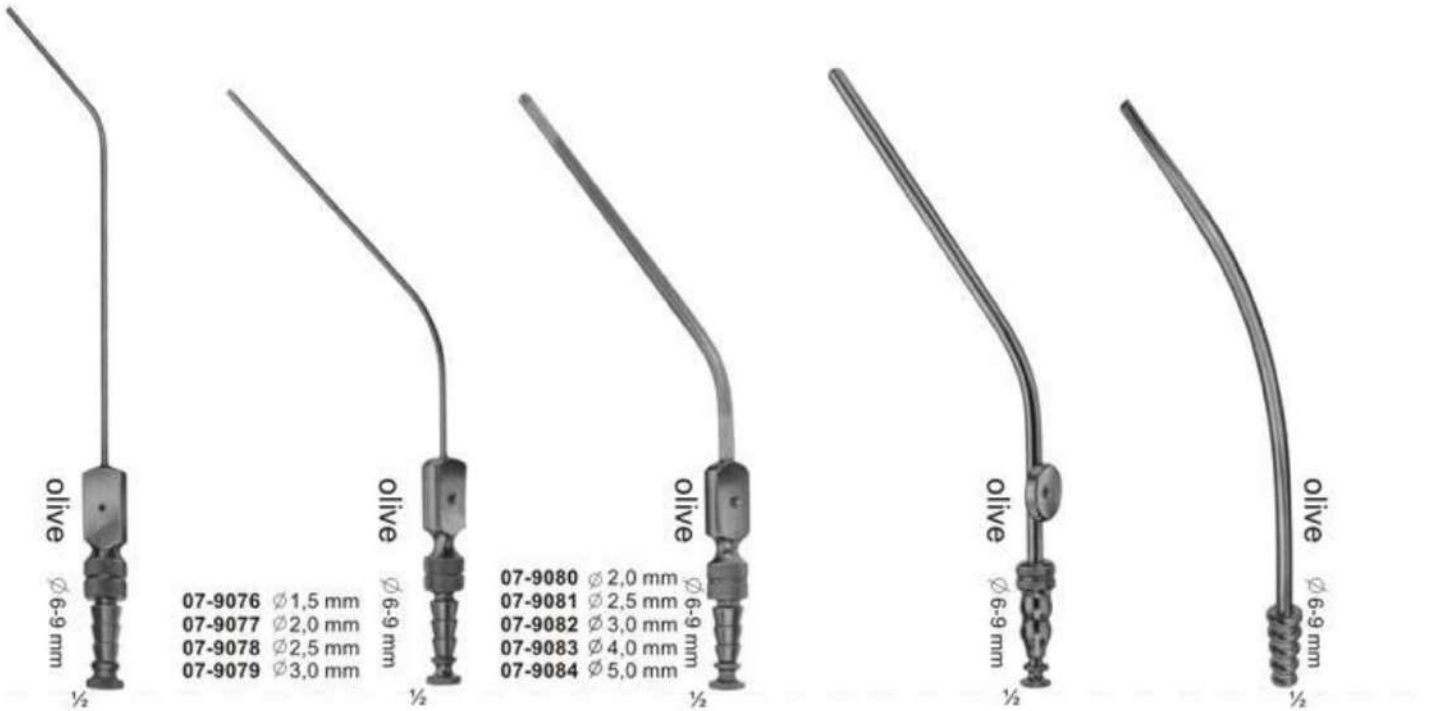

**07-9076**  $\varnothing$  1,5 mm  
**07-9077**  $\varnothing$  2,0 mm  
**07-9078**  $\varnothing$  2,5 mm  
**07-9079**  $\varnothing$  3,0 mm

**07-9080**  $\varnothing$  2,0 mm  
**07-9081**  $\varnothing$  2,5 mm  
**07-9082**  $\varnothing$  3,0 mm  
**07-9083**  $\varnothing$  4,0 mm  
**07-9084**  $\varnothing$  5,0 mm

**07-9076 - 07-9079**  
**PLESTER**  
with finger cut-off and stylet, thumb piece parallel to curve, with LUER hub  
195 mm

**07-9080 - 07-9084**  
**FERGUSSON**  
with finger cut-off and stylet, thumb piece 90° to curve, with LUER hub  
180 mm

**07-9085**  $\varnothing$  4mm  
**FERGUSSON**  
insulated, with finger cut-off and stylet, thumb piece 90° to curve, with LUER hub  
180 mm

**07-9086**  $\varnothing$  3mm  
**07-9087**  $\varnothing$  5mm  
**FRAZIER**  
with finger cut-off and stylet, thumb piece 90° to curve, with LUER hub  
180 mm

**07-9088**  
5,0 mm diam., Tip 6,5 mm wide, Nasal suction tube, with LUER hub  
180 mm

**AllWell Instruments co.**  
The name of Health Cure Instruments



**07-9089** 4,5 mm  
**07-9090** 5,5 mm  
Nasal suction tubes  
175 mm

**07-9091**  
**GORNEY**  
Suction dissector  
180 mm

**07-9092** 4 mm wide  
**07-9093** 5 mm wide  
Suction raspatories, sharp, bayonet-shaped, with stylet  
200 mm

**07-9094**  
**LOPEZ-REINKE**  
Tonsil dissector with suction device  
235 mm

# Suction Instruments

**07-9095**  
**WULLSTEIN**  
Suction tube, conical, silver, olive  
with LUER hub  
160 mm



**07-9096** 1,5 mm  
**07-9097** 2,0 mm  
**WULLSTEIN**  
Suction tube, cylindrical, silver, with  
stylet olive with LUER hub  
160 mm



Usable length

YASARGIL usable length diam.		YASARGIL usable length diam.	
<b>07-9098</b>	130 mm 1,5 mm	<b>07-9106</b>	130 mm 2,5 mm
<b>07-9099</b>	150 mm 1,5 mm	<b>07-9107</b>	150 mm 2,5 mm
<b>07-9100</b>	180 mm 1,5 mm	<b>07-9108</b>	180 mm 2,5 mm
<b>07-9101</b>	220 mm 1,5 mm	<b>07-9109</b>	220 mm 2,5 mm
<b>07-9102</b>	130 mm 2,0 mm	<b>07-9110</b>	130 mm 3,5 mm
<b>07-9103</b>	150 mm 2,0 mm	<b>07-9111</b>	150 mm 3,5 mm
<b>07-9104</b>	180 mm 2,0 mm	<b>07-9112</b>	180 mm 3,5 mm
<b>07-9105</b>	220 mm 2,0 mm	<b>07-9113</b>	220 mm 3,5 mm
		<b>07-9114</b>	180 mm 4,5 mm

olive  
Ø 6,5-9 mm  
with LUER hub



**AllWell Instruments co.**  
The name of Health Care Instruments

**07-9115 - 07-9117** **07-9115** 8 mm / curved  
**LANDOLT** **07-9116** 11mm / curved  
150 MM **07-9117** 15mm / curved  
diam Ø 3 mm



**07-9118** 500 mm  
**07-9119** 350 mm  
with rubber tip,  
with LUER hub

**07-9120** 2,0 mm diam  
**07-9121** 2,5 mm diam  
**07-9122** 3,0 mm diam  
with finger cut-off,  
thumb piece 90° to  
curve, with LUER hub  
250 mm





# Combined Suction and Irrigation Cannulae, Coagulation Suction Cannulae



## Scissors with Tungsten Carbide Inserts

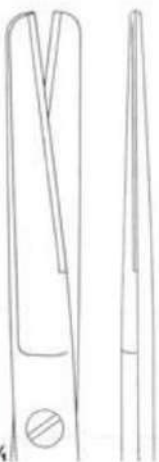

07-9131 - 07-9133  
STANDARD

07-9131 14,5cm  
07-9132 16,5cm  
07-9133 18,5cm

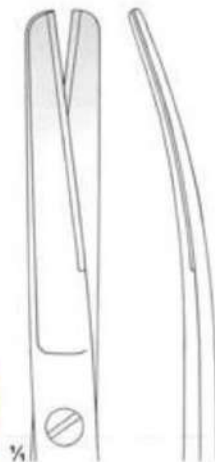

07-9134 - 07-9136  
STANDARD

07-9134 14,5cm  
07-9135 16,5cm  
07-9136 18,5cm

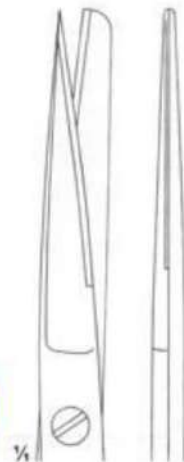

07-9137 - 07-9139  
STANDARD

07-9137 14,5cm  
07-9138 16,5cm  
07-9139 18,5cm

**AllWell Instruments co.**

The name of Health Care Instruments



07-9140 - 07-9142  
STANDARD

07-9140 14,5cm  
07-9141 16,5cm  
07-9142 18,5cm

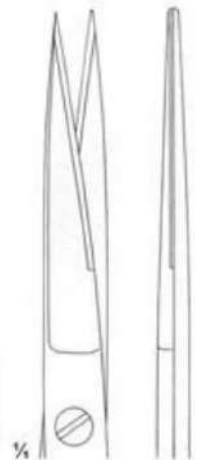

07-9143 - 07-9145  
STANDARD

07-9143 14,5cm  
07-9144 16,5cm  
07-9145 18,5cm



07-9146 - 07-9148  
STANDARD

07-9146 14,5cm  
07-9147 16,5cm  
07-9148 18,5cm

## Scissors with Tungsten Carbide Inserts

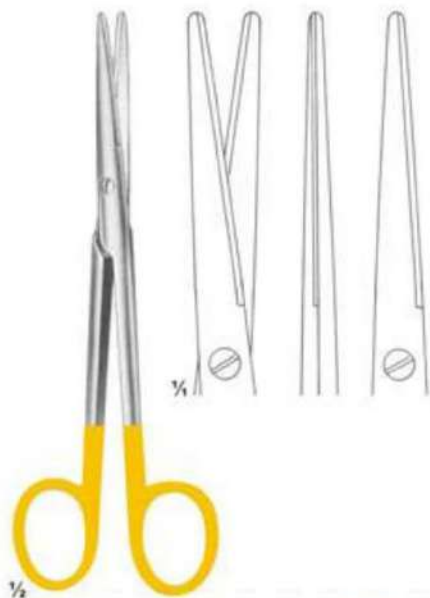

**07-9149**  
MAYO-LEXER  
16cm

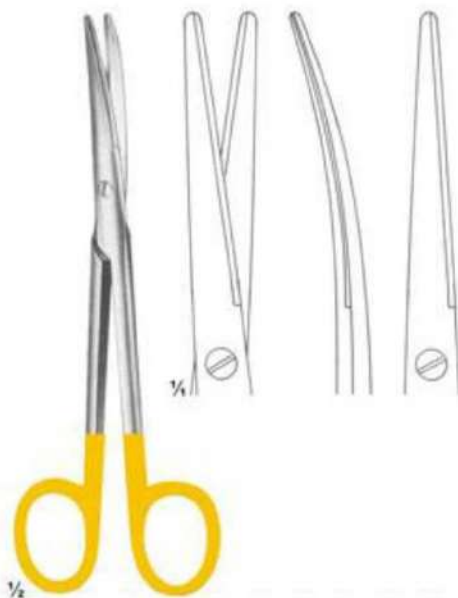

**07-9150**  
MAYO-LEXER  
16cm



**07-9151 - 07-9152**  
LEXER

**07-9151** 16cm  
**07-9152** 21cm



**AllWell Instruments co.**

The name of Health Care Instruments

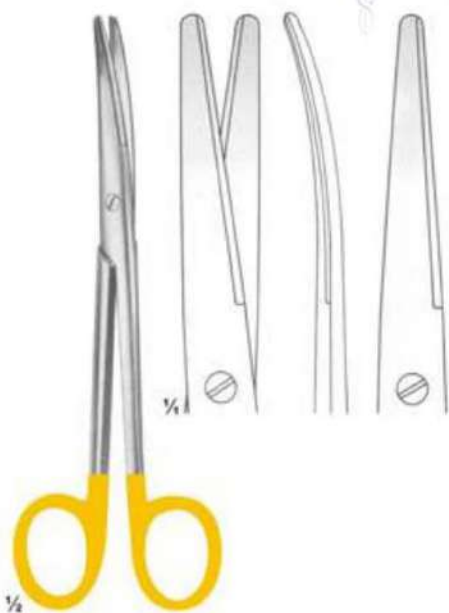

**07-9153 - 07-9154**  
LEXER

**07-9153** 16cm  
**07-9154** 21cm



**07-9155 - 07-9156**  
MAYO-STILLE

**07-9155** 15cm  
**07-9156** 17cm

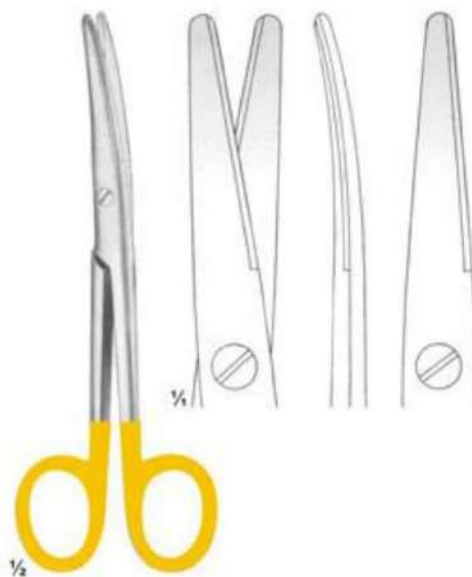

**07-9157 - 07-9158**  
MAYO-STILLE

**07-9157** 15cm  
**07-9158** 17cm



## Scissors with Tungsten Carbide Inserts



07-9159 - 07-9160  
METZENBAUM

07-9159 11.5cm  
07-9160 14.5cm



07-9161 - 07-9164  
METZENBAUM

07-9161 11.5cm  
07-9162 14.5cm  
07-9163 23cm  
07-9164 25cm



07-9165 - 07-9170  
METZENBAUM

07-9165 18cm  
07-9166 20cm  
07-9167 23.5cm  
07-9168 25.5cm  
07-9169 28cm  
07-9170 30cm

**AllWell Instruments co.**

The name of Health Cure Instruments



07-9171 - 07-9176  
METZENBAUM-FINO

07-9171 14cm  
07-9172 18cm  
07-9173 20cm  
07-9174 23cm  
07-9175 25cm  
07-9176 28cm



07-9177 - 07-9182  
METZENBAUM-FINO

07-9177 14cm  
07-9178 18cm  
07-9179 20cm  
07-9180 23cm  
07-9181 25cm  
07-9182 28cm

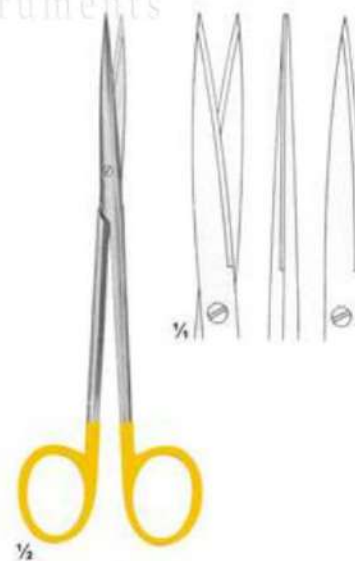

07-9183 - 07-9186  
METZENBAUM-FINO

07-9183 14cm  
07-9184 18cm  
07-9185 20cm  
07-9186 23cm

## Scissors with Tungsten Carbide Inserts

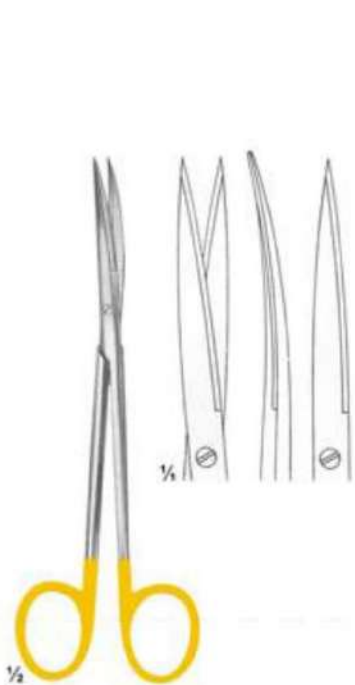

07-9187 - 07-9190  
METZENBAUM-FINO

07-9187 14cm  
07-9188 18cm  
07-9189 20cm  
07-9190 23cm

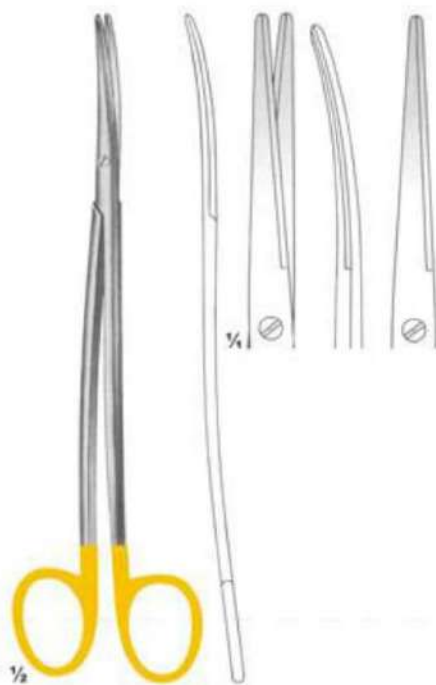

07-9191 - 07-9193  
METZENBAUM-FINO

07-9191 18cm  
07-9192 20cm  
07-9193 23cm

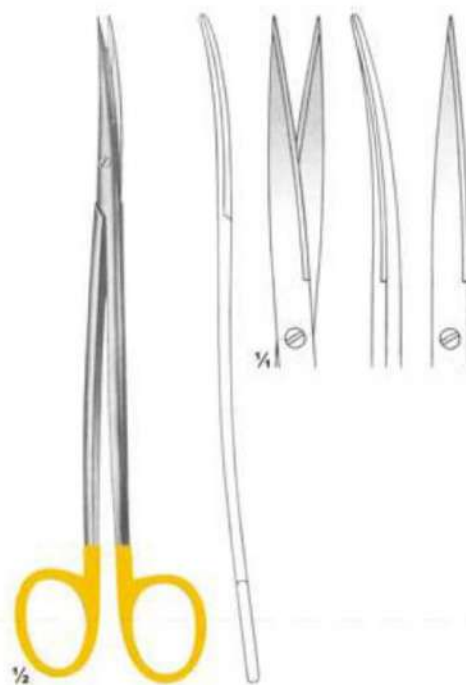

07-9194 - 07-9196  
METZENBAUM-FINO

07-9194 18cm  
07-9195 20cm  
07-9196 23cm

# AllWell Instruments co.

The name of Health Cure Instruments



07-9197 - 07-9198  
METZENBAUM

07-9197 20cm  
07-9198 23cm

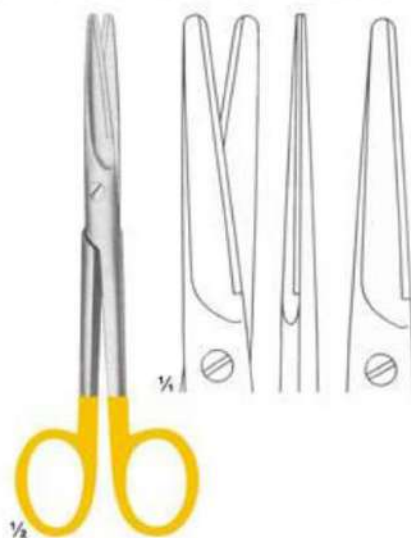

07-9199 - 07-9201  
MAYO

07-9199 14.5cm  
07-9200 17cm  
07-9201 23cm



07-9202 - 07-9204  
MAYO

07-9202 14.5cm  
07-9203 17cm  
07-9204 23cm

## Scissors with Tungsten Carbide Inserts





## Scissors with Tungsten Carbide Inserts



**07-9209 - 07-9211**  
DE-BAKEY  
(Potts-Smith)



**07-9209** 23cm 25  
**07-9210** 23cm 45  
**07-9211** 23cm 60

**07-9212 - 07-9214** **07-9212** 19cm 25  
**DE-BAKEY** **07-9213** 19cm 45  
(Potts-Smith) **07-9214** 19cm 60

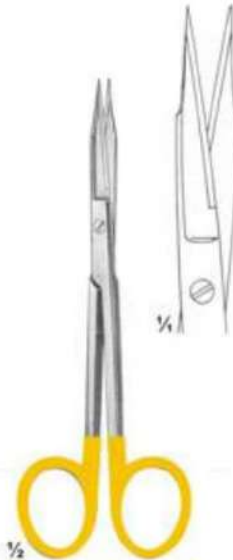

**07-9215**  
**GOLDMANN FOX**  
13cm

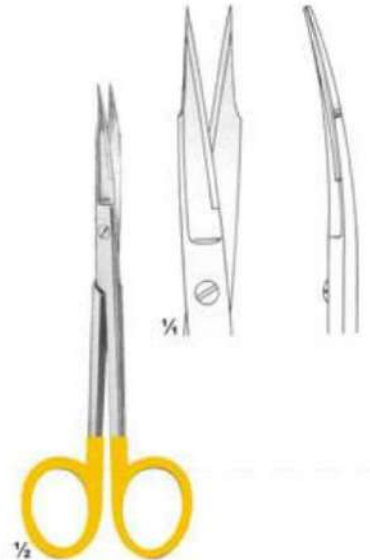

**07-9216**  
**GOLDMANN FOX**  
13cm



**AllWell Instruments co.**

The name of Health Cure Instruments

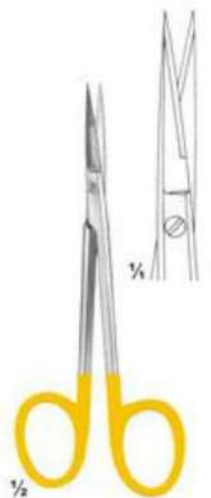

**07-9217**  
Fine Scissor  
11,5cm

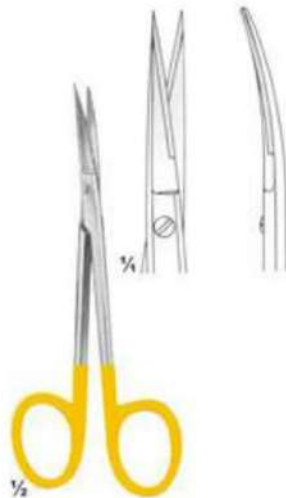

**07-9218**  
Fine Scissor  
11,5cm



**07-9219**  
11,5cm

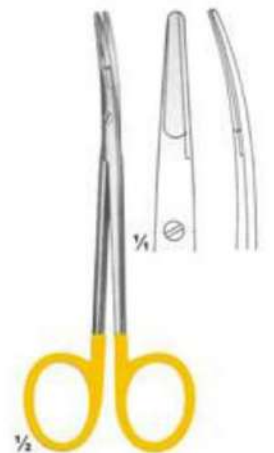

**07-9220**  
**RAGNELL (Kilner)**  
12cm

# Scissors & Dissecting Forceps with Tungsten Carbide Inserts

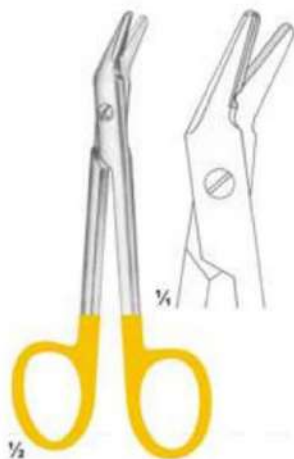

**07-9221**  
UNIVERSAL  
12cm



**07-9222 - 07-9224**  
SUTURE SCISSORS  
1 Black & 1 Gold Plated ring

**07-9222** 14cm  
**07-9223** 17cm  
**07-9224** 23cm

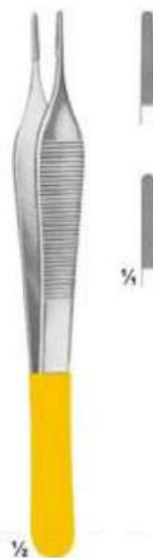

**07-9225 - 07-9226**  
ADSON

**07-9225** 12cm  
**07-9226** 15cm



**07-9227**  
CUSHING  
With dissector end  
17.5cm



**AllWell Instruments co.**  
The name of Health Cure Instruments



**07-9228**  
CUSHING  
With dissector end  
18cm



**07-9229**  
CUSHING-TAYLOR  
18cm



**07-9230**  
DISSECTING FORCEPS  
15cm



**07-9231**  
SEMKEN  
15cm

# Dissecting Forceps and Needle holders with Tungsten Carbide Inserts

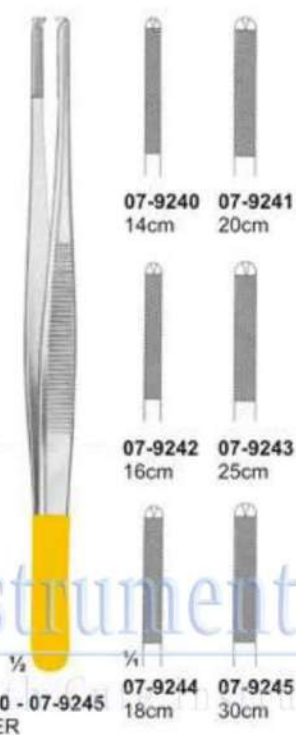
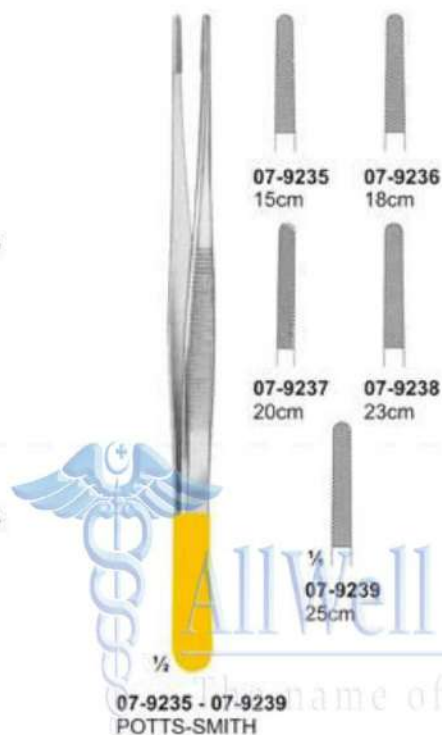
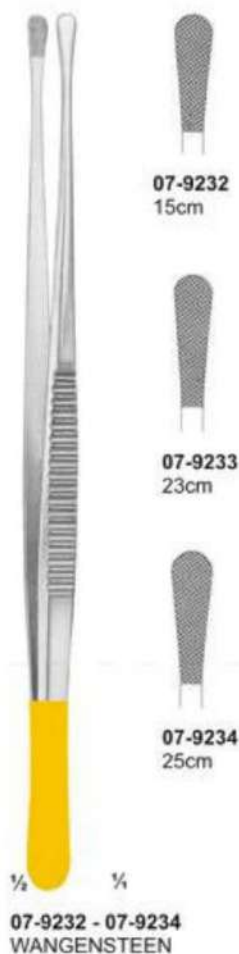



# Needle holders with Tungsten Carbide Inserts



**07-9251**  
ARRUGA  
16cm

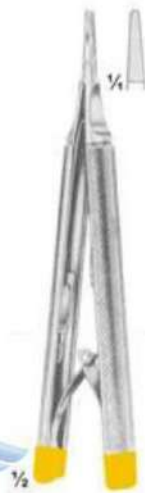

**07-9252**  
CASTROVIEJO  
13cm

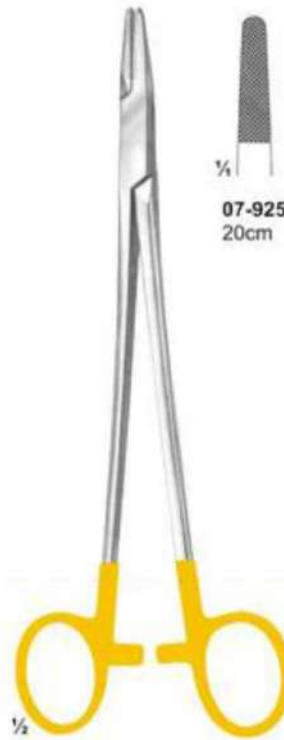

**07-9253 - 07-9254**  
HEGAR

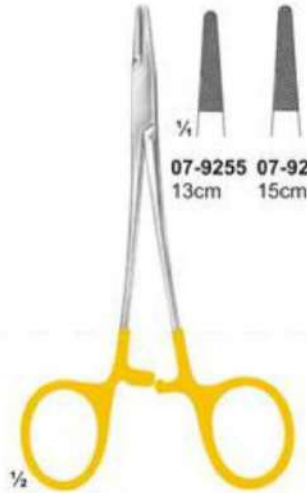

**07-9255 - 07-9256**  
HALSEY



**07-9257 - 07-9262**  
MAYO-HEGAR



**07-9263 - 07-9268**  
DE-BAKEY



**07-9269 - 07-9272**  
HEGAR-VASCULAR



**AllWell Instruments co.**

The name of Health Care Instruments

## Needle holders with Tungsten Carbide Inserts

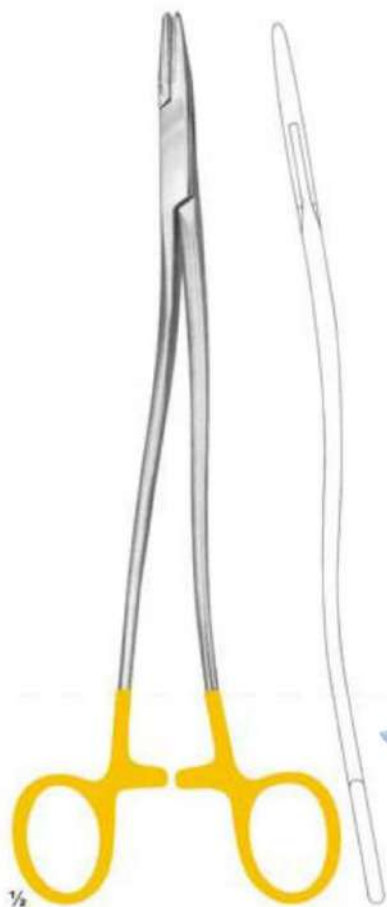

**07-9273 - 07-9275**  
**BOZEMANN**

**07-9273** 20cm  
**07-9274** 24cm  
**07-9275** 26cm



1/4

22cm 23cm



1/2

**07-9278 - 07-9283**  
**RYDER**

**07-9278** 13cm  
**07-9279** 15cm  
**07-9280** 18cm  
**07-9281** 20cm  
**07-9282** 23cm  
**07-9283** 26cm



AllWell Instruments Co.

The name of Health Care Instruments



1/4

**07-9284 - 07-9288**  
**RYDER-VASCULAR**

**07-9284** 13cm  
**07-9285** 15cm  
**07-9286** 20cm  
**07-9287** 23cm  
**07-9288** 26cm



1/4

**07-9289 - 07-9291**  
**MARTIN**

**07-9289** 15cm  
**07-9290** 17cm  
**07-9291** 20cm

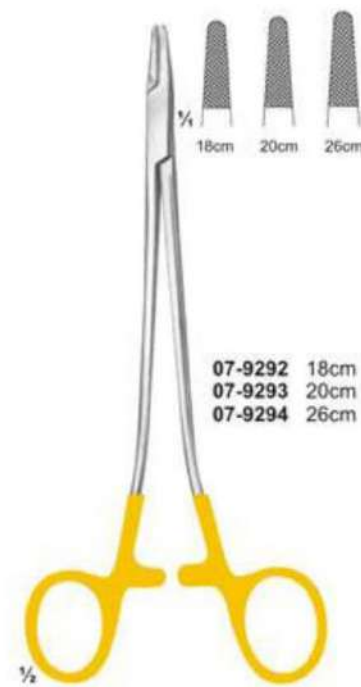

1/4

**07-9292 - 07-9294**  
**SAROT**

**07-9292** 18cm  
**07-9293** 20cm  
**07-9294** 26cm

## Needle holders with Tungsten Carbide Inserts

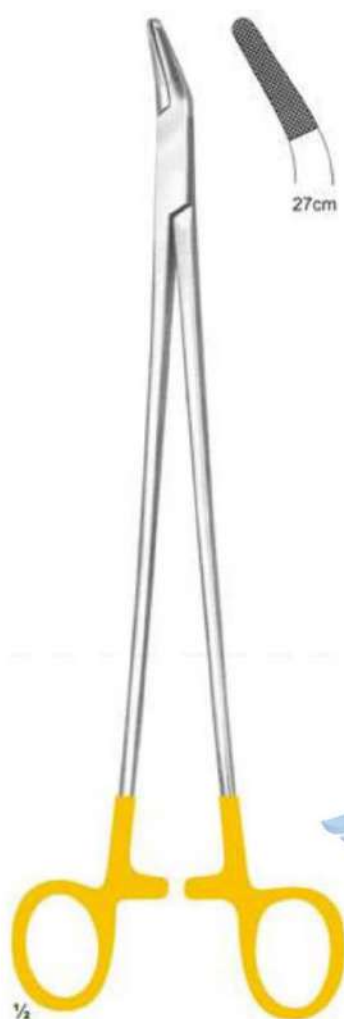

**07-9295**  
**FINOCHIETTO**  
27cm



**07-9296 - 07-9297A**  
**HEANEY**  
07-9296 20cm  
07-9297 24cm  
07-9297A 26cm

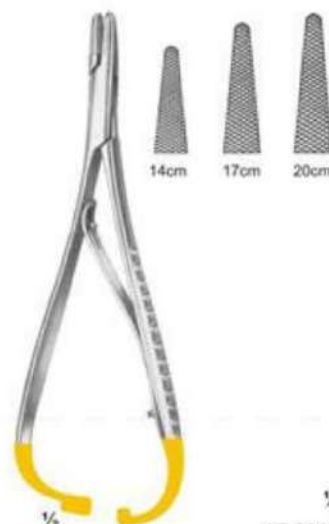
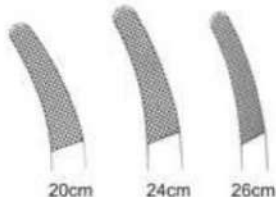

**07-9298 - 07-9300**  
**MATHIEU**  
07-9298 14cm  
07-9299 17cm  
07-9300 20cm

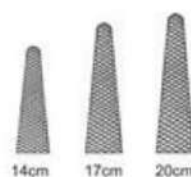

**07-9301 - 07-9303**  
**MATHIEU-KOCHER**  
07-9301 17cm  
07-9302 20cm  
07-9303 23cm



AllWell Instruments co.  
The name of Health Care Instruments



**07-9304 - 07-9307**  
**MATHIEU-KOCHER**  
07-9304 14cm  
07-9305 17cm  
07-9306 20cm  
07-9307 24cm



**07-9308 - 07-9310**  
**MATHIEU-VASCULAR**  
07-9308 17cm  
07-9309 20cm  
07-9310 24cm

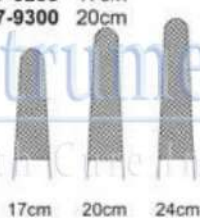

**07-9311 - 07-9313**  
**MATHIEU-VASCULAR**  
07-9311 17cm  
07-9312 20cm  
07-9313 24cm



## Needle holders with Tungsten Carbide Inserts

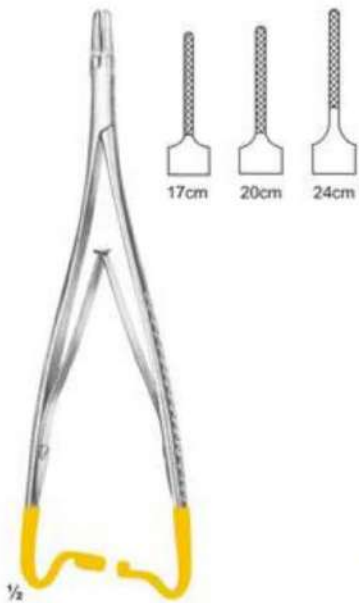

07-9314 - 07-9316  
MATHIEU-RYDER  
07-9314 17cm  
07-9315 20cm  
07-9316 24cm



07-9317  
LICHTENBERG  
20cm



07-9318 - 07-9319  
LANGHALS  
07-9318 20cm  
07-9319 25cm



07-9320 - 07-9321  
LICHTENBERG  
07-9320 20cm  
07-9321 25cm



07-9322 - 07-9323  
LUETHY-BECK  
07-9322 20cm  
07-9323 25cm

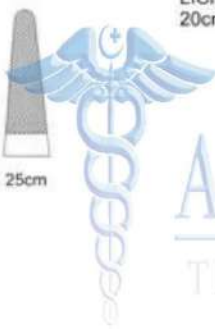

AllWell Instruments Co.  
The name of Health Cure Instruments



07-9324 - 07-9325  
LUETHY-BECK  
07-9324 20cm  
07-9325 25cm



07-9326 - 07-9328  
LANGENBECK  
07-9326 18cm  
07-9327 20cm  
07-9328 23cm



07-9329 - 07-9331  
LANGENBECK  
07-9329 18cm  
07-9330 20cm  
07-9331 23cm

## Needle holders with Tungsten Carbide Inserts and Without TC



**07-9332**  
**STEVENS**  
15 cm



**07-9333**  
**KALT**  
14 cm



**07-9334**  
**KALT "HM"**  
14 cm



**AllWell Instruments co.**

The name of Health Cure Instruments



with catch

**07-9335 - 07-9338**  
**CASTROVIEJO**  
**07-9335** 14 cm STR  
**07-9336** 17 cm STR  
**07-9337** 14 cm CVD  
**07-9338** 17 cm CVD



with catch

**07-9339 - 07-9340**  
**CASTROVIEJO**  
**07-9339** 14 cm  
**07-9340** 17 cm



with catch

**07-9341**  
**CASTROVIEJO "HM"**  
13 cm

# Needle holders with Tungsten Carbide Inserts and Without TC



**07-9342- 07-9345**  
CASTROVIEJO "HM"  
07-9342 14 cm smooth  
07-9343 17 cm smooth  
07-9344 14 cm serrated  
07-9345 17 cm serrated



**07-9346 - 07-9347**  
CASTROVIEJO-MICRO  
14, 5 cm  
07-9346 14.5 cm STR  
07-9347 14.5 cm CVD



**07-9348 - 07-9349**  
CASTROVIEJO-MICRO  
14, 5 cm  
07-9348 14.5 cm STR  
07-9349 14.5 cm CVD

Ultra Fine



**07-9350 - 07-9351**  
CASTROVIEJO  
(KOSHIMA)  
14, 5 cm  
07-9350 14.5 cm STR  
07-9351 14.5 cm CVD



**07-9352 - 07-9353**  
CASTROVIEJO  
(KOSHIMA)  
14, 5 cm  
07-9352 14.5 cm STR  
07-9353 14.5 cm CVD

**AllWell Instruments co.**

The name of Health Care Instruments



# Needle holders with Tungsten Carbide Inserts and Without TC



**07-9354 - 07-9355**  
BARRAQUER  
07-9354 11, 5 cm  
07-9355 14 cm



**07-9356 - 07-9357**  
BARRAQUER  
07-9356 11, 5 cm  
07-9357 14 cm



**07-9358 - 07-9359**  
JACOBSON "HM"  
07-9358 18, 5 cm  
07-9359 21 cm



**07-9360 - 07-9361**  
JACOBSON "HM"  
07-9360 18, 5 cm  
07-9361 21 cm



**07-9362 - 07-9363**  
JACOBSON  
07-9362 18, 5 cm  
07-9363 21 cm



**07-9364 - 07-9365**  
JACOBSON "HM"  
18 cm  
07-9364 18 cm STR  
07-9365 18 cm CVD



**07-9366 - 07-9367**  
JACOBSON "HM"  
18 cm  
07-9366 18 cm STR  
07-9367 18 cm CVD

**AllWell Instruments co.**  
The name of Health Cure Instruments

# Micro Needle Holders



**07-9368 - 07-9369**  
MICRO 2000  
12 cm  
**07-9368** 12 cm STR  
**07-9369** 12 cm CVD



**07-9370 - 07-9371**  
MICRO 2000  
12 cm  
**07-9370** 12 cm STR  
**07-9371** 12 cm CVD



**07-9372**  
MICRO 2000  
15 cm



**07-9373 - 07-9374**  
MICRO 2000  
15 cm  
**07-9373** 15 cm STR  
**07-9374** 15 cm CVD



**07-9375 - 07-9376**  
YASARGIL  
16 cm  
**07-9375** 16 cm STR  
**07-9376** 16 cm CVD



**AllWell Instruments co.**  
The name of Health Cure Instruments

# Wire Cutting Plier With T.C. Inserts



1/2  
**07-9377**  
**TOENNIS**  
Elastic pattern for  
dura-or intestinal suture  
180 mm



**07-9378**  
Cutting Plier  
12 cm



**AllWell Instruments co.**

The name of Health Care Instruments



**07-9379**  
**MULLAR CLAUS**  
22 cm



**07-9380**  
Plier  
17.5 cm



## Dressing Sterilizing Drums, Storing Cases and Needle Cases



**07-9381 - 07-9395**  
**SCHIMMELBUSCH**  
without filter laterally  
perforated lockable  
by sliding mechanism.

	Ø x H sizes in mm
07-9381	80 x 80
07-9382	105 x 120
07-9383	140 x 140
07-9384	160 x 120
07-9385	160 x 150
07-9386	190 x 150
07-9387	190 x 190
07-9388	240 x 160
07-9389	240 x 240
07-9390	290 x 160
07-9391	290 x 240
07-9392	340 x 160
07-9393	340 x 340
07-9394	390 x 190
07-9395	390 x 290



**07-9396**  
**BOX**  
120 x 65 x 13mm  
(without Bulldog clamps,  
without silicone tape)



**07-9397 - 07-9409**  
**KONRICH**

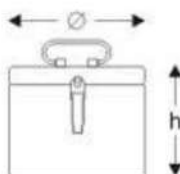

	Ø x H sizes in mm
07-9397	100 x 100
07-9398	150 x 150
07-9399	200 x 150
07-9400	200 x 190
07-9401	240 x 160
07-9402	240 x 230
07-9403	290 x 160
07-9404	290 x 240
07-9405	340 x 160
07-9406	340 x 240
07-9407	390 x 145
07-9408	390 x 240
07-9409	390 x 290



**07-9410**  
Box with support for  
needle electrodes,  
without instruments



**07-9411**  
50 x 25 x 4,5 mm  
**07-9412**  
65 x 42 x 8 mm  
**07-9413**  
75 x 25 x 4,5 mm



**07-9414**  
Box with support  
120 x 65 x 13 mm  
(with bulldog clamps)

**07-9415**  
Ø 62mmx13mm  
Interior box  
perforated lid  
and bottom.



**07-9416**  
complete with perforated  
interior box.  
Ø 65mm x 15mm

## Jars and Instrument boxes



Ø x H	Jar without lid	lid only	lid only with triangle hole
30x90mm	07-9417	07-9426	07-9435
50x100mm	07-9418	07-9427	07-9436
50x130mm	07-9419	07-9428	07-9437
50x175mm	07-9420	07-9429	07-9438
75x100mm	07-9421	07-9430	07-9439
75x130mm	07-9422	07-9431	07-9440
75x175mm	07-9423	07-9432	07-9441
100x175mm	07-9424	07-9433	07-9442
100x200mm	07-9425	07-9434	07-9443

07-9417 - 07-9443

**AllWell Instruments co.**

The name of Health Cure Instruments



07-9468  
205 x 105 x 35 mm

07-9444 - 07-9467

	L x B x H	Lid with knob	Lid without knob
07-9444	165 x 85 x 35 mm	07-9452	07-9460
07-9445	200 x 100 x 35 mm	07-9453	07-9461
07-9446	200 x 100 x 50 mm	07-9454	07-9462
07-9447	230 x 130 x 50 mm	07-9455	07-9463
07-9448	260 x 150 x 50 mm	07-9456	07-9464
07-9449	270 x 235 x 50 mm	07-9457	07-9465
07-9450	300 x 200 x 50 mm	07-9458	07-9466
07-9451	325 x 275 x 50 mm	07-9459	07-9467

## Dressing Forceps in Jar with Cap



**07-9469 - 07-9470**

- 07-9469** Sterilizing Forceps  
consisting of:  
1 Sterilizing Forceps, curved, 25 cm,  
without ratchet, with lid for jar  
1 jar with wide bottom plate (anti-tilt)
- 07-9470** ditto, with 32 cm long Sterilizing Forceps



# Round Metal Boxes, Medicine Cups and Kidney Dishes



Lid with knob

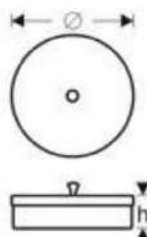

07-9471 - 07-9477

	Ø x H
07-9471	75 x 60 mm
07-9472	75 x 75 mm
07-9473	100 x 60 mm
07-9474	100 x 100 mm
07-9475	125 x 80 mm
07-9476	125 x 125 mm
07-9477	150 x 150 mm



07-9478  
25 cc  
graduated  
inside

07-9479  
50 cc  
graduated  
inside



07-9480  
20 cc  
Medicine Spoon  
graduated  
inside



07-9481  
Ø 75 x 12 mm  
Tablet Tray



07-9482  
Ø 90 x 90 mm  
Metal Cup



07-9483  
Ø 75 x 80 mm  
Sputum Cup



Kidney Dish



Lid for kidney dishes

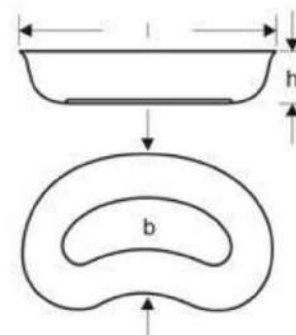

07-9484 - 07-9486

	L x B x H
07-9484	170 x 100 x 35 mm
07-9485	250 x 140 x 40 mm
07-9486	275 x 150 x 45 mm

## Round Bowls, Graduated Measures and Trays



**07-9487 - 07-9494**

	∅ x H		
07-9487	40 x 19 mm	0.05L	
07-9488	61 x 30 mm	0.07L	
07-9489	80 x 40 mm	0.14L	
07-9490	116 x 50 mm	0.35L	
07-9491	128 x 55 mm	0.45L	
07-9492	147 x 65 mm	0.70L	
07-9493	167 x 75 mm	1.10L	
07-9494	187 x 85 mm	1.60L	



**07-9495 - 07-9499**

	∅ x H		
07-9495	116 x 35 mm	0.30L	
07-9496	128 x 38 mm	0.40L	
07-9497	147 x 40 mm	0.50L	
07-9498	157 x 45 mm	0.75L	
07-9499	187 x 45 mm	1.00L	



**07-9500**  
∅ 110 x 28 mm 0.15L



**07-9501**  
100 cc = 0.1L  
graduated  
inside



**07-9502 - 07-9505**

07-9502	0,25L
07-9503	0,50L
07-9504	1,00L
07-9505	2,00L
	graduated inside



**07-9506**  
235 x 190 x 40 mm



**07-9507**  
∅ 220 x 70 mm

## Powder Strewer, Triangular Basins, Placenta and Bed Pans



**07-9508**  
∅ 50 x 100 mm  
Powder Pot



**07-9509**  
∅ 50 x 75 mm  
Methot With Lid



**07-9510**  
∅ 50 x 75 mm  
Methot Without Lid



**AllWell Instruments co.**  
The name of Health Care Instruments



graduated inside upto 600ml with handle

**07-9511**



graduated inside upto 600ml

**07-9512**



**07-9513**  
PLACENTA PAN



**07-9514 - 07-9515**  
BED PAN  
**07-9514** ∅ 235 mm  
**07-9515** ∅ 310 mm



## Needle Sterilizing Cases



**07-9516**  
Sauerbruch  
210 x 125 x 17 mm  
perforated lid and  
bottom



**07-9517**  
Sauerbruch  
210 x 125 x 17 mm  
perforated lid and  
bottom



**07-9518**  
150 x 95 x 13 mm



**07-9519**  
150 x 95 x 13 mm  
perforated lid and  
bottom



**07-9520**  
150 x 95 x 13 mm  
perforated bottom



**07-9521**  
150 x 95 x 13 mm  
perforated lid and  
bottom



**07-9522**  
150 x 95 x 13 mm



**07-9523**  
150 x 95 x 13 mm  
perforated lid and  
bottom



**07-9524**  
150 x 95 x 11 mm  
Needle tray perforated  
bottom

## Storing Cases Perforated Bottom with Textile Filter



**07-9525**  
Deponette  
245 x 135 x 35mm

Perforated bottom,  
with textile filter ref.



**07-9526**  
Deponette  
245 x 135 x 50mm

Perforated bottom,  
with textile filter ref.



AllWell Instruments co.

The name of Health Cure Instruments



**07-9527**  
Deponette  
245 x 135 x 60mm

Perforated bottom,  
with textile filter ref.



Perforated Bottom

## Universal Trays and Storing Cases



07-9528 - 07-9532

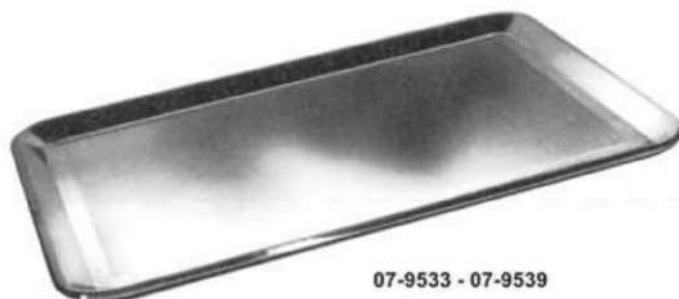
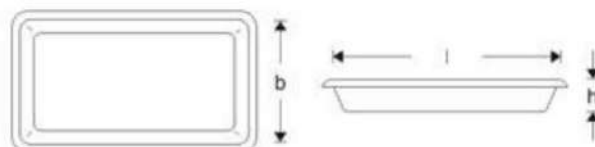

07-9533 - 07-9539

satin finish	size in mm l x b x h
07-9528	230 x 165 x 30
07-9529	300 x 155 x 30
07-9530	300 x 175 x 40
07-9531	350 x 240 x 36
07-9532	400 x 300 x 50

**AllWell Instruments co.**

satin finish	size in mm Ø x H
07-9533	210 x 160 x 10
07-9534	240 x 180 x 10
07-9535	310 x 150 x 10
07-9536	310 x 210 x 10
07-9537	350 x 240 x 10
07-9538	400 x 270 x 20
07-9539	420 x 280 x 10



07-9540 - 07-9550

	L x H x B	mm
07-9540	230 x 130 x 50	mm
07-9541	260 x 150 x 50	mm
07-9542	275 x 235 x 50	mm
07-9543	300 x 200 x 50	mm
07-9544	325 x 275 x 50	mm
07-9545	420 x 175 x 50	mm
07-9546	230 x 130 x 75	mm
07-9547	260 x 150 x 75	mm
07-9548	300 x 200 x 75	mm
07-9549	325 x 275 x 75	mm
07-9550	420 x 175 x 75	mm



## Sterilizing Baskets / Trays

Sterilizing tray of wire mesh  
for container 30cm long



**07-9553**  
250 x 250 x 50mm

**07-9551** 480 x 250 x 50 mm  
**07-9552** 520 x 250 x 75 mm  
**07-9553** 520 x 250 x 100 mm  
Sterilizing Trays of wire mesh  
for container 60cm long.

07-9551 - 07-9553

**AllWell Instruments co.**  
The name of Health Care Instruments



Sterilizing tray of perforated steel sheet **07-9554 - 07-9559**

**07-9554** 240 x 240 x 50 mm  
**07-9555** 240 x 240 x 80 mm  
**07-9556** 240 x 240 x 100 mm  
**07-9557** 480 x 260 x 50 mm  
**07-9558** 520 x 260 x 80 mm  
**07-9559** 520 x 260 x 100 mm

## Sterilizing Basket

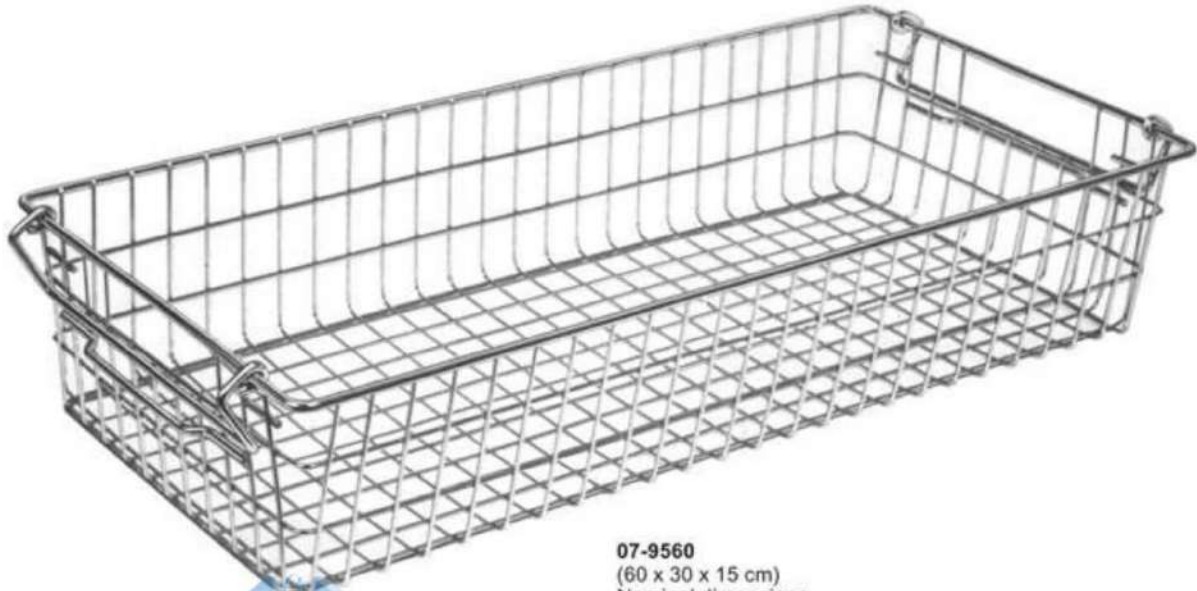

07-9560  
(60 x 30 x 15 cm)  
Nominal dimensions



AllWell Instruments co.

The name of Health Care Instruments

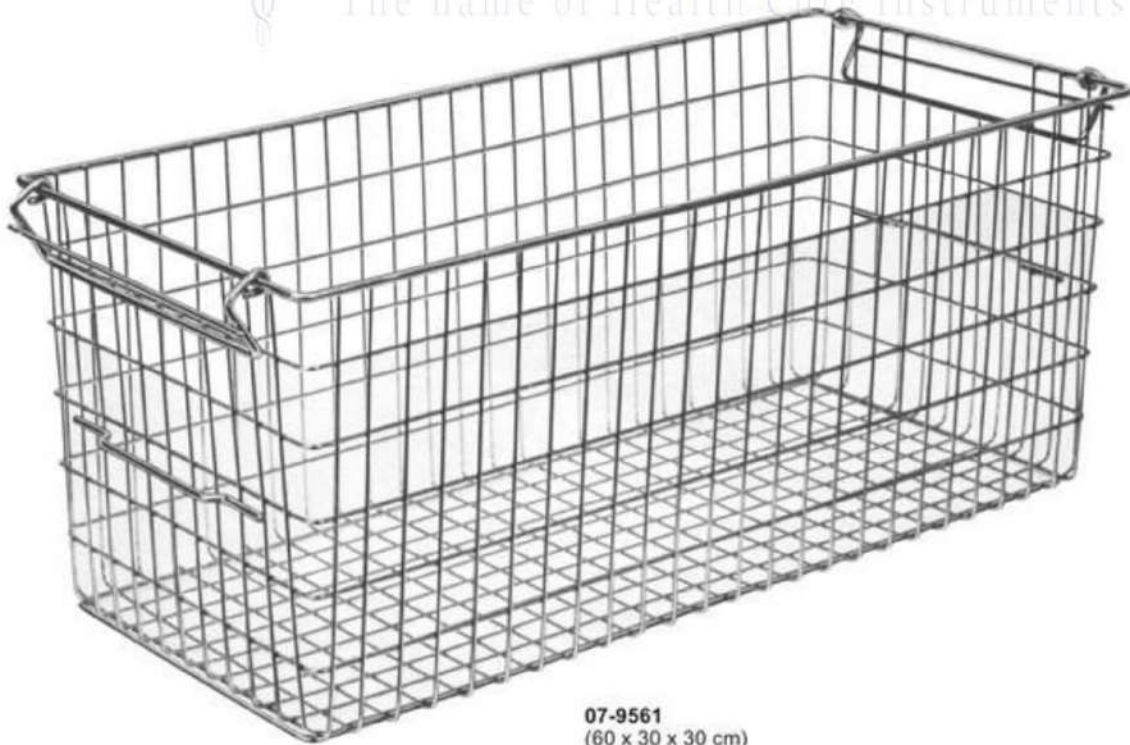

07-9561  
(60 x 30 x 30 cm)  
Nominal dimensions



# ALPHABETICAL INDEX

## A

<b>Abdominal Blades</b>	163
Retractors	144-147, 162-164-167
<b>Abraham Tonsil Knife</b>	17
<b>Adson Delicate Haemostatic Forceps</b>	80
Dissecting Forceps	55,62,411
Needle Holders	98
Raspatories	334
Retractors	155-156
<b>Adson-Baby Self-Retaining Retractors</b>	154
<b>Adson-Brown Tissue Forceps</b>	63
<b>Aesthesiometers</b>	1
<b>Alexander Bone Rongeurs</b>	367
Gouges	353
Rib Raspatories	299
Organ Grasping Forceps	74
Retractors	151
Sponge Forceps	68
<b>Allen Intestinal Clamps</b>	173
<b>Allis Artery Traction Forceps</b>	73
Intestinal Grasping Forceps	171
Lung Grasping Forceps	290
Tissue Grasping Forceps	168
<b>Allison Lung Spatulas</b>	138,309
<b>ALY Aesthesiometers</b>	1
<b>Amputation Knives</b>	16,319
Retractors	320
Saws	321-322
<b>Anastomosis Clamps</b>	184-186,265-266, 269-270,275-276, 285-286
	155
<b>Anderson-Adson Retractors</b>	155
<b>Andrew Tongue Depressors</b>	5
<b>Anestrophon Stethoscope</b>	2
<b>Angle Wire Cutters</b>	388
<b>Antrum Trocars</b>	208
<b>Anusscopes</b>	189
<b>Aorta Clamps</b>	280-281,288
<b>Aorta-Anastomosis Clamps</b>	282
<b>Aorta-Aneurysm Clamps</b>	278-279
<b>Aorta Cross Clamps</b>	276-277
<b>Aortic Dilators</b>	260
<b>Appendectomy Clamps</b>	182
<b>Apprex Elevating Forceps</b>	235
<b>Arruga Forceps</b>	62
Needle Holders	96,412,413
<b>Artery Traction Forceps</b>	73
<b>Asch Secretion Curette/Scoop</b>	237
<b>Aspiration Curettes</b>	398
<b>Ateriotomy Scissors</b>	34
<b>Aufricht Bone Rasps</b>	339
<b>Austin Micro Forceps</b>	52
<b>Autopsy Knives</b>	13,16
<b>Auricle Clamps</b>	294
<b>Auvard Vaginal Speculums</b>	218
<b>Ayre Cone Knife</b>	17

## B

<b>Babcock Intestinal Grasping Forceps</b>	169,171
Lung Grasping Forceps	290
<b>Baby-Adson Forceps</b>	87
<b>Baby-Allis Artery Traction Forceps</b>	73
<b>Baby-Allis Tissue Grasping Forceps</b>	168
<b>Baby-Collin Abdominal Retractors</b>	162
<b>Baby-Crile Delicate Haemostatic Forceps</b>	80
<b>Baby-Kocher Intestinal Clamps</b>	173
<b>Baby-Metzenbaum Scissors</b>	38
<b>Baby-Mikulicz Peritoneum Forceps</b>	91

<b>Baby-Mixer Forceps</b>	87
<b>Baby-Mosquito, Delicate Haemostatic Forceps</b>	79
<b>Baby-Nail Scissors</b>	49
<b>Baby-Overholt Forceps</b>	87
<b>Baby-Roux Retractors</b>	123
<b>Baby-Senn-Miller Retractors</b>	123
<b>Backhaus Towel Clamps</b>	75
<b>Backhaus-Kocher Towel Clamps</b>	75
<b>Bailey Rib Spreaders and Contractors</b>	307
<b>Bainbridge Intestinal Clamps</b>	173
<b>Bakes Common Bile Duct Dilators</b>	198
<b>Balfour Abdominal Retractors</b>	165
<b>Balfour-Baby Abdominal Retractors</b>	164
<b>Bandage Cutting Scissors</b>	49-51,393,394
<b>Bane-Hartmann Bone Rongeurs</b>	366
<b>Barraquer Micro Needle Holders</b>	97,419
Retractors	151
<b>Barth Bone Curettes</b>	342
<b>Bayonet Shaped Forceps</b>	53-54,61
<b>Bumgartner Needle Holders</b>	98
<b>Beckmann-Adson Retractors</b>	156
<b>Beckmann-Eaton Retractors</b>	156
<b>Beebe Wire and Plate Scissors</b>	48
<b>Beer Cilia Forceps</b>	66
<b>Bed Pans</b>	426
<b>Bending Pliers</b>	387
<b>Bengolea Delicate Haemostatic Forceps</b>	81
<b>Bennett Bone Levers</b>	330
<b>Berger Biopsy Forceps</b>	240
<b>Bergh Cilia Forceps</b>	66
<b>Bergmann Mallets</b>	350
Plaster Scissors	394
Trachea Retractors	118
<b>Berliner Percussion Hammer</b>	1
<b>Bertillon Caliper for Head</b>	11
<b>Bethune Rib Shears</b>	296
<b>Beyer Bone Rongeurs</b>	367
<b>Biemer Curettes for Aspiration Lipectomy</b>	398
Vein Scissors	24
<b>Bier Amputation Saws</b>	322
<b>Bircher Meniscus and Cartilage Forceps</b>	377
<b>Bircher-Ganske Meniscus &amp; Cartilage Forceps</b>	377
<b>Biopsy Curettes</b>	237
Forceps	238-240
Forceps For Rectum	190-191
<b>Biopsy Instruments</b>	237-240
Tips	240
<b>Bioptome</b>	260
<b>Bishop-Harmon Forceps</b>	62
<b>Blade Breakers</b>	19
<b>Bladder Retractors</b>	204
Spatula	204
<b>Blake Embolus Grasping Forceps</b>	257
Gall Duct Dilators	198
Gall Stone Forceps	199
Uterine Curettes	242
<b>Blood Lancet</b>	7
<b>Blumenthal Bone Rongeurs</b>	366
<b>Bohler Bone Cutting Forceps</b>	374
Bone Rongeurs	368
Traction Bows	382
<b>Bonaccolto Forceps</b>	55
<b>Bone Clamps</b>	364
Curettes	342-347
Cutting Forceps	297,373-376
Files	399-341
Holding Forceps	358-363
Levers	324-330
Rasps	339-341
Retractors	125
Rongeurs	365-372







# ALPHABETICAL INDEX

<b>Coronary Artery Scissors</b>	39	<b>De Bakey-Pean Atraumata Haemostatic Forceps</b>	268
<b>Cottle Bulldog Scissors</b>	33	<b>De Bakey-Satinsky Tengential Occlusion Clamps</b>	272
Chisels	353	<b>De Lee Pelvimeter</b>	246
Forceps	61	<b>Dean Tonsil Scissors</b>	41
Mallets	348	<b>Deaver Retractors</b>	139-143
Nasal Scissors	41	Surgical Scissors (Flat Lock)	32
Osteotomes	353	<b>Dejerine Percussion Hammer</b>	1
Raspatories	333,335	<b>Delicate Dissecting Forceps</b>	55-56
Retractors	122	Haemostatic Forceps	79-81
Wound Retractors	117	Scissors	26-29,33,41
<b>Cotton Applicators</b>	109,110,224	Tissue Forceps	62
<b>Crafoord Auricle Clamps</b>	294	<b>Demel Wire Guide</b>	384
Delicate Haemostatic Forceps	81	<b>Denhardt Mouth Gag</b>	6
<b>Crafoord-Sellors Auricle Clamps</b>	294	<b>Denis Browne Intestinal Forceps</b>	65,170
<b>Cranioclast</b>	254	<b>Derf Needle Holders</b>	98
<b>Crile Delicate Forceps</b>	80	<b>Dermotomes</b>	22
Needle Holders	100	<b>Derra Multi Purpose Clamps</b>	266
Nerve and Vessel Hook	115	<b>Derra-Cooley Anastomosis Clamps</b>	285
Retractors	123	<b>Deschamps Ligature Needles</b>	103,104
<b>Crile-Murray Needle Holders</b>	98	<b>Desjardins Forceps</b>	90,194
<b>Crile-Wood Needle Holders</b>	98	Gall Duct Probes	197
<b>Cusco Vaginal Speculums</b>	209,210	Gall Stone Forceps	199
<b>Cushing Dissecting Forceps</b>	56,411	Gall Stone Probes	198
Nerve and Vessel Hooks	115,116	<b>Desmarres Retractors</b>	122
Retractors	122	<b>Deponette Storing Cases</b>	429
Rongeurs	316	<b>Diagnostic Sets</b>	8
<b>Cushing-Kocher Retractors</b>	122	<b>Dick Anastomosis Clamps</b>	184,276
<b>Cushing -Taylor Forceps Bayonet</b>	411	Atraumata Compression Clamps	94
<b>Czerny Gall Stone Forceps</b>	199	<b>Dieffenbach Bulldog Clamps</b>	77
Retractors	124	Scalpels	14
Tenaculum Forceps	229	<b>Diethrich Aorta Clamps</b>	280
		Scissors	39
		<b>Dilators</b>	256,257
		<b>Dingmann Bone Holding Forceps</b>	358
		<b>Directors Probes</b>	107
		<b>Distractors</b>	382
		<b>Dissecting Forceps</b>	57,58,87-90, 263,269,291- 292,411
		Knives	12
		Scissors	33-38,409
		<b>Dittel Gall Duct Dilators</b>	198
		Urethral Bougies	206
		<b>Doyen Gall Bladder Forceps</b>	196
		Intestinal Clamps	174-176
		Myoma Screws	236
		Needle Holder	98
		Ovum Forceps	232
		Directors	107
		Raspatories	298,337
		Retractors	146-147
		Towel Clamps	75
		Vaginal Speculums	216,217
		<b>Doyen-Child Fixation Device</b>	147
		<b>Dressing Forceps</b>	67-71
		Sterilizing Drums	422
		<b>Drilling Chucks</b>	383
		<b>Duplay Sponge Forceps</b>	67
		Tenaculum Forceps	228
		<b>Durogrip Bone Rasps</b>	340
		Wire Holding Forceps	386
		<b>Durotip Angle Wire Cutters</b>	388
		Wire Cutting Pliers	389,391
		Wire Cutting Scissors	388
		<b>Dura Knives</b>	18
		Retractors	117
		Scissors	40
		<b>Duval Intestinal Forceps</b>	65,169
		Intestinal Grasping Forceps	170
		Lung Grasping Forceps	290
		<b>Duval-Collin Intestinal Grasping Forceps</b>	169
<b>Dandy Delicate Forceps</b>	79		
<b>Dardik Multi Purpose Clamps</b>	289		
<b>Dartigues Elevating Forceps</b>	233		
Kidney Elevating Forceps	202		
<b>Daubenspeck Bone Curettes</b>	345		
<b>Davidson Scapula Retractors</b>	139,308		
<b>Davis Vascular Spatulas</b>	258		
<b>De Bakey Anastomosis Forceps</b>	186		
Aorta Clamps	281		
Aorta-Aneurysm Clamps	278,279		
Ateriotomy Scissors	34		
Bulldog Clamps	78		
Clamps	264-283		
Coarctation Clamps	272,273		
Dissecting Forceps	263		
Forceps (Full range)	60,172,263		
Multi Purpose Clamps	266,283		
Needle Holders	413		
Offset Scissors	39		
Patent-Ductus Clamps	273		
Peripheral-Vascular Clamps	274,275		
Retractors	157		
Rib Spreaders	303		
Ring Handle Bulldog Clamps	264		
Scissors	410		
Suction Cannulae	309,401		
Tangential Occlusion Clamps	271,272		
Vascular Clamps	274,275		
Vascular Dilators	257		
Vessel Scissors	39		
<b>De Bakey-Beck Vena Cava Clamps</b>	270		
<b>De Bakey-Bainbridge Atraumata Haemostatic Forceps</b>	267		
<b>De Bakey-Harken Vena Cava Clamps</b>	271		
<b>De Bakey-Hess Bulldog Clamps</b>	77		
<b>De Bakey-Kelly Atraumata Haemostatic Forceps</b>	268		
<b>De Bakey-Mixer Dissecting &amp; Ligature Forceps</b>	269		



# ALPHABETICAL INDEX

## E

<b>Echlin</b> Bone Rongeurs	369
<b>Eiselsberg</b> Ligature Scissors	47
Needle Holders	100
<b>Eiselsberg-Mathieu</b> Needle Holder	101
<b>Elevators</b>	258,299,324, 331-336
<b>Elsching</b> Forceps	62
<b>Embolus</b> Grasping Forceps	257
<b>Emmet</b> Fistula Hooks	121
Sponge and Dressing Forceps	69
<b>Empyema</b> Trocars	208
<b>Endarterectomy</b> Strippers	259
<b>Endospecula For Cervix</b>	223
<b>Engel</b> Plaster Saw	393
<b>Engl. Mod.</b> Towel Clamps	75
<b>Enucleation</b> Scissors	35
<b>Episiotomy</b> Scissors	45,248
<b>Eppendorf</b> Biopsy Forceps	240
<b>Esmarch</b> Bandage & Plaster Scissors	51,394
Plaster Knife	393
<b>Ether</b> Mask	6
<b>Examination and Measuring Instruments</b>	11
<b>Exploration</b> Hooks	116
<b>Extension</b> Cannulae	240
Cord	4
<b>Extraction</b> Pliers	387
<b>Eye</b> Scissors	23

## F

<b>Farabeuf</b> Bone Holding Forceps	360
Raspatories	336
Retractors	123
<b>Farabeuf-Lambotte</b> Bone Holding Forceps	360
<b>Farrell</b> Cotton Applicators	109,110
<b>Faure</b> Biopsy Forceps	238
Peritoneum Forceps	91
<b>Favoloro</b> Artery Scissors	39
<b>Feilchenfeld</b> Splinter Forceps	66
<b>Female</b> Catheters Urinary Instruments	206
<b>Femur</b> Retractor	157
<b>Fergusson</b> Bone Holding Forceps	359
Haemorrhoidal Forceps	193
Suction Tube	402
<b>Fergusson-Ackland</b> Mouth Gag	6
<b>Ferris-Smith-Kerrison</b> Punches	312
<b>Fiber Optic</b> Batery Handle	10
<b>Fine</b> Scissors	33,34,410
<b>Finger</b> Nail Drill	392
Nail Instruments	392
Ring Saw	392
<b>Finochietto</b> Dissecting & Ligature Forceps	89,291
Needle Holders	415
Rib Spreaders	300,301
<b>Finochietto-Burford</b> Rib Spreaders	302
<b>Finsen</b> Self-Retaining Retractors	151
<b>Finsterer</b> Combined Cannulae	404
<b>Fishtail</b> Chisel	353
<b>Fistula</b> Hooks	121
<b>Fixation</b> Clamp	380
Discs	381
<b>Flap Knives</b>	16
<b>Flat Nosed</b> Pliers	386,387
<b>Foerster-Ballenger</b> Sponge Holding Forceps	70
<b>Fomon</b> Dissecting Scissors	35
Forceps	60-61
Nasal Scissors	41
Rasps/Bone File	340
Retractors	120

<b>Forceps</b>	52-66
With Tungsten Carbide Inserts	411-412
<b>Ford-Bowles</b> Stethoscopes	2
<b>Foregger</b> Laryngoscopes	10
<b>Fowler</b> Tonsil Knife	17
<b>Francke</b> Blood Lancet	7
<b>Frazier</b> Fine Wound Retractors	117
Suction Tube	402
<b>Freer</b> Chisels	351
Fine Wound Retractors	117
Gouges	351
Raspatories	332,333
Vascular Spatulas	258
<b>Freer-Yasargil</b> Raspatories	333
<b>Frenzel</b> Tongue Depressors	5
<b>Fricke</b> Artery Forceps	58,82
<b>Fritsch</b> Retractors	146

## G

<b>Gall Bladder</b> Forceps	196
Trocars	208
<b>Gall Duct</b> Dilators	198
Forceps	194-195
Probes	197
Scissors	196
<b>Gall Stone</b> Forceps	199
Scoops	198
<b>Gallaher</b> Bone File	339
<b>Gastro-Intestinal</b> Forceps	181
<b>Gauss</b> Scalp Flap Forceps	251
<b>Gelpi</b> Retractors	157
Vaginal Retractors	220
<b>Genito-Urinary</b> Instruments	205-207
<b>Gerald</b> Dissecting Forceps	56
Tissue Forceps	64
<b>Gerster</b> Bone Clamps	364
<b>Gieritz- Stille</b> Rib Shears	296
<b>Gigli</b> Wire Saws and Handle	323
<b>Gill</b> Forceps	62
<b>Gill-Hess</b> Forceps	62
<b>Gillies</b> Fine Wound Retractors	117
Needle Holders	100
Tissue Forceps	64
<b>Glass</b> Rods	236
<b>Glover</b> Anastomosis Clamps	269,270
Bulldog Clamps	78
Vena Cava Clamps	270
<b>Gluck</b> Rib Shears	296
<b>Goldmann-Fox</b> Scissors	410
<b>Good</b> Tonsil Scissors	41
<b>Gorney</b> Suction Dissector	402
<b>Gosset</b> Abdominal Retractors	164
<b>Gouges</b>	351-353,355-356
<b>Graduated inside</b>	425
<b>Graefe</b> Fine Wound Retractors	117
Knives	14
Nerve and Vessel Hooks	115
Tissue Forceps	63
<b>Grave</b> Vaginal Speculums	211
<b>Gray</b> Forceps	90,195
<b>Green-Armytage</b> Obstetrics Forceps	251
<b>Gross</b> Sponge Forceps	67
<b>Gruenwald</b> Forceps	61
<b>Guedel-Negus</b> Laryngoscopes	9
<b>Guide</b>	259
<b>Guiding</b> Probes	105,106
<b>Guthrie</b> Fine Wound Retractors	117
<b>Guyon</b> Catheter Guide	206



# ALPHABETICAL INDEX

Kidney Clamps	200
Urethral Bougies	206-207
<b>Gynaecological Instruments</b>	245
Scissors	43-44

## H

<b>Haase Tamper</b>	351
Reposition Forceps	357
<b>Haberer Intestinal Spatulas</b>	150
<b>Haemostatic ATRAUMATA Forceps</b>	267,268
<b>Haemostatic Forceps</b>	70,79-86,92
<b>Haemorrhoidal Forceps</b>	192-193
<b>Hajek Irrigation Cannula</b>	197
Mallets	349
<b>Hajek-Kofler Punches</b>	311
<b>Halogen Replacement Lamp</b>	10
<b>Halle Bone Curettes</b>	345
Raspatories	332
Vascular Spatulas	258
<b>Halsey Needle Holder</b>	98,413
<b>Halsted Delicate Forceps</b>	80,81
<b>Halsted-Mosquito Delicate Forceps</b>	79,81
<b>Handles</b>	7,20,21,137,215, 219,240,259,261, 323,399
<b>Harken Vena Cava Clamps</b>	293
<b>Hartmann Intestinal Clamps</b>	174
<b>Harvey Wire Cutting Scissors</b>	48,388
<b>Harrington Retractors</b>	138
<b>Harrington-Pemberton Retractors</b>	308
<b>Head Bands</b>	3
Lights	4
Mirrors	3
<b>Heaney Hysterectomy Forceps</b>	92,93
Needle Holders	415
<b>Heaney (Hegar) Needle Holders</b>	99
<b>Heath Clip Removing Forceps</b>	111
Mallet	350
<b>Hebra Comedone Extractors</b>	18
<b>Hegar Needle Holders</b>	99,413
Uterine Dilators	221-222
<b>Hegar-Olsen Needle Holders</b>	100
<b>Hegar-Vascular Needle Holders</b>	413
<b>Hegenbarth Clip Applying Forceps</b>	111
<b>Heiss Delicate Haemostatic Forceps</b>	81
Ligature Forceps	89
<b>Heister Mouth Gag</b>	6
<b>Hemingway Bone Curettes</b>	343
<b>Hennig Plaster Spreader</b>	397
<b>Hepp-Scheidle Needle Holders</b>	412
<b>Herberhold Pocket-Accu</b>	4
<b>Herff Membrane Puncturing Forceps</b>	247
<b>Herget Biopsy Forceps</b>	190
<b>Herrick Kidney Pedicle Clamps</b>	201
<b>Hertzler Retractors</b>	164
Rib Spreaders	300
<b>Herz Tendon Seizing Forceps</b>	72
<b>Hess Forceps</b>	62
<b>Hey Groves Bone Holding Forceps</b>	362
<b>Heymann-Knight Nasal Scissors</b>	41
<b>Heywood-Smith Gall Bladder Forceps</b>	196
Haemorrhoidal Forceps	192
Ovum Forceps	231
Sponge Holding Forceps	71
Tongue Forceps	6
<b>Hoepfner Vessel Clamps</b>	292
<b>Hohmann-Aldinger Bone Levers</b>	329
<b>Holzbach Abdominal Retractor</b>	162
<b>Hopkins Plaster Instruments</b>	393
<b>Hose Connection</b>	244

<b>Hosel Retractors</b>	131
<b>Hosemann Choledochus Forceps</b>	195
<b>Hospital Wares</b>	422-432
<b>House Irrigation Cannulae</b>	404
<b>Howarth Raspatories</b>	333
<b>Huber Handle</b>	240
<b>Hunt Tumor &amp; Vessel Forceps</b>	54
<b>Hunter Splinter Forceps</b>	66
<b>Hurd Ligature Needles</b>	104
<b>Hysterectomy Forceps</b>	92-94

## I

<b>Incision Surgical Scissors</b>	32
<b>Inge Lamina Spreaders</b>	161
<b>Instrument Boxes</b>	422,423
<b>Instruments for Micro Tubal Operation</b>	236
<b>Interosseous Knife</b>	16,319
<b>Intestinal Clamps</b>	173-180
Forceps	65,168-171
Spatulas	149-150
<b>Intestinal And Pylorus Clamps</b>	183
<b>Iowa Membrane Puncturing Forceps</b>	247
<b>Irrigation Cannulae</b>	257,404
<b>Israel Retractors</b>	127
<b>Ives-Fansler Anusscopes</b>	189

## J

<b>Jackson Tendon Seizing Forceps</b>	72
Tracheal Tubes	255
Vaginal Speculums	214
<b>Jackson Burrows Retractors</b>	157
<b>Jacobs Tenaculum Forceps</b>	230
<b>Jacobson Bone Curettes</b>	342
Needle Holder	96,419
<b>Jaeger Fine Wound Retractors</b>	117
<b>Jager Tendon Seizing Forceps</b>	72
<b>Jameson Dissecting Scissors</b>	34
Needle Holder	99
<b>Jansen Bone Curettes</b>	342,343
Bone Rongeurs	366,367
Forceps	61
Head Light with Plastic Band	4
Raspatories	336
Retractors	151
<b>Jars</b>	423,424
<b>Jenkner Instrument set for Tunnelling and Pulling-through Vascular Grafts</b>	261
<b>Jeweler Forceps</b>	52
<b>Bulldog Clamps</b>	77
<b>Joll (Friedman) Retractors</b>	157,220
<b>Jones Towel Clamps</b>	75
<b>Jonesco Ligature Needles</b>	104
<b>Jordan Instruments</b>	385
<b>Joseph Bone File</b>	339
Delicate Scissors	29
Fine Wound Retractors	117
Nasal Knives	18
Raspatories	331
<b>Judd-Allis Tissue Grasping Forceps</b>	168
<b>Judd-Masson Bladder Retractors</b>	204

## K

<b>Kader Intestinal Spatula</b>	149
<b>Kalt Needle Holders</b>	96,417



# ALPHABETICAL INDEX

<b>Kazanjian</b> Bone Cutting Forceps	373	<b>Lahey (Sweet)</b> Dissecting and Ligature Forceps	90
<b>Kelly</b> Delicate Forceps	79	Gall Duct Forceps	194
Delicate Scissors	29	<b>Lambotte</b> Bone Holding Forceps	363
Obstetrical Forceps	254	Osteotomes	353,354
Ovum Forceps	231	Rib Raspatories	299
Proctoscopes	189	<b>Lamina</b> Spreaders	161
Retractors	133,145	<b>Laminectomy</b> Retractors	155,156,158
Sphincteroscopes	189	<b>Landolt</b> Coagulation Suction Cannulae	404
Sponge Holding Forceps	71	Enucleation Scissors	35
<b>Kern-Lane</b> Bone Holding Forceps	361	Raspatories	335
<b>Kerpel</b> Bone Curettes	343	Suction Cannulae	403
<b>Kerrison</b> Punches	311	<b>Lane</b> Bone Holding Forceps	361,362
<b>Kerrison-Jacoby</b> Punches	312	Bone Levers	326
<b>Kersting</b> Anastomosis Forceps	186	Intestinal Forceps Twin	181
<b>Kidney</b> Clamps	200-201	Intestinal Grasping Forceps	170
Dishes	425	Tissue Forceps	65
Elevating Forceps	202	Towel Clamps	75
Stone Forceps	203	<b>Lane Trethowan</b> Bone Levers	326
<b>Killian</b> Bone Shears	42	<b>Lange</b> Fistula Hooks	121
Probes	109	<b>Lange-Hohmann</b> Bone Levers	326
Raspatories	333	<b>Langenbeck</b> Amputation Saws	322
Rectal Specula	187	Bone Holding Forceps	359
<b>Kilner</b> Dissecting Scissors	34,410	Bone Levers	324
Fine Wound Retractors	117	Elevators	324
Needle Holder	98	Flap Knife	16
<b>Kirschner</b> Guiding Probes	106	Head Light	4
Retractors	167	Needle Holders	416
Wire Traction	380,381	Raspatories	336
<b>Kirschner-Balfour</b> Blade	167	Resection Knives	14,319
<b>Klapp</b> Tendon Hooks	121	Retractors	128
<b>Kleinschmidt</b> Spur Crusher	182	Rib Raspatories	299
<b>Klima Rosegger</b> Sternal Puncture Needle	208	<b>Langenbeck-Green</b> Retractors	120
<b>Knives</b>	12-14,16-18,	<b>Langenbeck-Mannerfelt</b> Retractors	119
	319	<b>Langhals</b> Needle Holders	416
<b>Knot tier and Ligature Adjuster</b>	106	<b>Laryngeal</b> Mirrors	7
<b>Knowles</b> Bandage Scissors	49	<b>Laryngoscopes</b>	9,10
<b>Kocher</b> Bladder Spatulas	204	<b>Lathbury-Farrell</b> Cotton Applicators	109,110
Bone Retractors	125,126	<b>Lawrence</b> Forceps	89
Guiding Probes	106	<b>Lazar</b> Micro Forceps	52
Haemostatic Forceps	84	<b>Lebsche</b> Conductor for Wire Saws	323
Intestinal Clamps	175,177,178	Sternum Chisels	296
Retractors	122,125,126,	<b>Lees</b> Bronchus Clamps	277
	129,130	<b>Legueu</b> Bladder Retractors	204
Suture Needles	104	Bladder Spatula	204
<b>Kocher-Langenbeck</b> Retractors	128	<b>Leksell-Stille</b> Bone Rongeurs	370
<b>Kocher-Ochsner</b> Haemostatic Forceps	85	<b>Leland-Jones</b> Peripheral-Vascular Clamps	274,275
<b>Koenig</b> Guiding Probes	106	<b>Lempert</b> Bone Curettes	345
Elevators	324	Bone Rongeurs	367
Raspatories	331	<b>Leriche</b> Intestinal Spatula	149
Retractors	122	<b>Lewis</b> Bone Rasps	339
<b>Koerte</b> Retractors	127	<b>Lewkowitz</b> Ovum Forceps	253
<b>Kogan</b> Endospecula	223	<b>Lexer</b> Gouges	355,356
<b>Kolle</b> Micro Needle Holders	7	Osteotomes	355,356
<b>Konrich</b> Sterilizing Drums	422	Scissors	37,406
<b>Krause</b> Biopsy Tips	240	<b>Lexer-Mini</b> Gouges	355
<b>Krayenbuhl</b> Nerve and Vessel Hooks	116	Osteotomes	355
<b>Kristeller</b> Vaginal Speculums	211-214	<b>Lichtenberg</b> Needle Holders	416
<b>Kronecker</b> Ligature Needles	103	<b>Ligature</b> Adjuster	106
<b>Kronlein</b> Haemostatic Forceps	82	Forceps	53,58,87-90,
<b>Krypton</b> Replacement Lamp	10		269,291-292
<b>Kuhne</b> Cover Glass Forceps	55	Needles	103-105
<b>Kummel</b> Intestinal Spatula	149	Pliers	386
<b>Kustner</b> Tenaculum Forceps	229	Scissors	47
		<b>Lister</b> Bandage Scissors	50
		Sinus Forceps	67
		<b>Liston</b> Bone Cutting Forceps	373,375
		Knife	16
		<b>Liston-Key-Horsley</b> Bone Cutting Forceps	297,376
		<b>Liston-Stille</b> Bone Cutting Forceps	297,376
		<b>Littauer</b> Ligature Scissors	47
		<b>Littler</b> Dissecting Scissors	33

## L

<b>Laborde</b> Tracheal Dilators	256
<b>Lahey</b> Artery Traction Forceps	73
Gall Duct Forceps	194
Tenaculum Forceps	228



# ALPHABETICAL INDEX

<b>Littlewood</b> Tenaculum Forceps	230	<b>Mayo-Adams</b> Retractors	154
<b>Liver</b> Retractor	145	<b>Mayo-Harrington</b> Scissors	36,409
<b>Lloyd-Davis</b> Sigmoid Anastomosis Forceps	185	<b>Mayo-Hegar</b> Needle Holders	99,413
<b>Lloyd-Davies</b> Rectal Scissors (Goligher's)	46	<b>Mayo-Lexer</b> Scissors	37,406
<b>Lockhart-Mummery</b> Probes	107	<b>Mayo-Noble</b> Scissors	36
<b>Locklin</b> Scissors	41	<b>Mayo-Robson</b> Intestinal Clamps	180
<b>Lockwood</b> Intestinal Grasping Forceps	169	<b>Mayo-Stille</b> Scissors	35,36,406
<b>Logan modif. Reill</b> Self-Retaining Retractors	151	<b>Mc Indoe</b> Forceps	56
<b>Lopez-Reinke</b> Tonsil Dissector	402	Tissue Forceps	64
<b>Lorna</b> Towel Clamps	76	<b>Mc Kenty</b> Raspatories	331
<b>Loute</b> Wire Tightener	383	<b>Mcintosh</b> Laryngoscopes	10
<b>Love-Gruenwald</b> Rongeurs	314,316,317	<b>Mead</b> Bone Rongeurs	367
<b>Lower</b> Forceps	90,194	Mallets	348
<b>Lowman</b> Bone Clamps	364	Raspatories	333
<b>Lowman-Gerster</b> Bone Clamps	364	<b>Measuring</b> Instruments	11
<b>Lowman-Hoglund</b> Bone Clamps	364	<b>Medicine</b> Cups	424
<b>Lucae</b> Forceps	61	Spoons	424
<b>Lucas</b> Bone Curettes	343	<b>Membrane</b> Puncturing Forceps	247
Chisels	352	<b>Meniscus</b> Knives	378,379
Gouges	352	Forceps	377
<b>Luethy-Beck</b> Needle Holders	416	<b>Mercedes</b> Retractor	306
<b>Luer</b> Bone Rongeurs	366,368	<b>Metacarpal</b> Saw	322
Haemorrhoidal Forceps	192	<b>Metal</b> Cups	424
Retractors	123	Round Boxes	424
Tracheal Tubes	255	<b>Method</b> Pot	426
<b>Luer-Friedmann</b> Bone Rongeurs	365	<b>Metzenbaum</b> Dissecting Scissors	26,38,407,408
<b>Luer-Koerte</b> Gall Stone Scoops	198	<b>Metzenbaum-Fino</b> Dissecting Scissors	407,408
<b>Luer-Stille</b> Bone Rongeurs	371,372	<b>Meyer</b> Reposition Forceps	357
<b>Lung</b> Dissecting Forceps	65	<b>Meyering</b> Retractors	120,134
Grasping Forceps	290	<b>Michel</b> Clip Applying and Removing Forceps	111
Spatulas, Retractors	138-143,308-309	Rhinoscopic Mirrors	7
<b>Luxation</b> Lever	330	<b>Micro</b> Dissecting Scissors	23-25
		Dissecting Scissors Bayonet	25
		Forceps	52,53
		Jeweller Types Forceps	52
		Ligature Forceps Bayonet	53-54,87
		Needle Holders	96-97,420
		Suture Tying Forceps	52
		<b>Micro-2000</b> Needle Holders	420
		<b>Micro-Adson</b> Forceps	55,62,87
		<b>Micro-Halsted</b> Delicate Forceps	79
		<b>Microscopic</b> Forceps	55
		<b>Middeldorpf</b> Retractors	130
		<b>Mikulicz</b> Forceps	86
		Intestinal Spatula	149
		Peritoneum Forceps	91
		Retractors	144,145
		<b>Milium</b> Knives	18
		<b>Miller</b> Laryngoscopes	9
		Rasps	340
		<b>Millin</b> Bladder Neck Spreader	205
		Bladder Retractors	204
		Center Blade for Retractors	204
		Ligature Holding Forceps	101
		Lobe Grasping Forceps	205
		<b>Mills</b> Gall Duct Scissors	196
		<b>Mirror</b> Handles	7
		<b>Mirrors</b> for Head light	4
		<b>Mixer</b> Dissecting and Ligature Forceps	89,90,292
		Gall Duct Forceps	195
		<b>Mixer-O'Shaughnessy</b> Forceps	89
		<b>Modell Piccolo</b> Cotton Applicators	109
		<b>Mod. USA</b> Plaster Spreader	397
		<b>Modell Tubingen</b> Retractors	135
		<b>Mollison</b> Self-Retaining Retractors	154
		<b>Molt</b> Raspatories	333
		<b>Moeltgen</b> Goniometer	11
		<b>Moncorps</b> Milium Knives	18
		<b>Mosquito</b> Atraumata Forceps	267
		<b>Morris</b> Anastomosis Clamps	186
		Ascending Aorta Cross Clamps	276

## M

<b>Mac Donald</b> Raspatories	333
<b>Magill</b> Forceps	8
<b>Maier</b> Sponge Forceps	68
<b>Maltz</b> Bone Rasps	339
<b>Mallets</b>	348-350
<b>Mannerfelt</b> Osteotomes	351,352
Raspatories	334
Retractors	119
<b>Markwalder</b> Rib Rongeurs	297
<b>Marquardt</b> Bone Rongeurs	368
<b>Martin</b> Meniscus and Cartilage Forceps	377
Needle Holders	414
Pelvimeters	246
Retractors	135
Tenaculum Forceps	228
Uterine Probes	224
Vaginal Speculums	218
<b>Martini</b> Bone Curettes	342
<b>Masing</b> Retractors	122
<b>Masson</b> Needle Holders	99
<b>Masson-Luethy</b> Needle Holders	99
<b>Mathieu</b> Foreign Body Forceps	205
Needle Holders	101,415
Rectal Specula	188
Retractors	124
Vaginal Speculums	215
<b>Mathieu-Kocher</b> Needle Holders	415
<b>Mathieu-Ryder</b> Needle Holders	416
<b>Mathieu-Stille</b> Needle Holders	101
<b>Mathieu-Vascular</b> Needle Holders	415
<b>Mayo</b> Gall Duct Probes	197
Safety Pin	76
Scissors	35-37,408
Uterine Probes	224





# ALPHABETICAL INDEX

Retractors	133
<b>Morse</b> Sternotomy Spreaders	304
<b>Mouth</b> Gags	6
<b>Moynihan</b> Forceps	86
Gall Stone Probes	197
Intestinal Clamps	179
<b>Muehling</b> Raspatories	335
<b>Mueller</b> Retractors	151
<b>Muller claus</b> Wire cutting Plier with T.C	421
<b>Multi-Purpose</b> Clamps	283,286-287,289
<b>Muller</b> Fine Wound Retractors	117
Ligature Forceps	77
Micro Forceps	53
Micro Needle Holders	97
Vessel Clips	77
<b>Murphy</b> Head band	3
<b>Murphy-Lane</b> Luxation Levers	330
<b>Museux</b> Artery Traction Forceps	73
Tenaculum Forceps	230
<b>Myoma</b> Instruments	236
Screws	236
<b>Myomatome</b>	17,236
<b>Myrtle</b> Leaf Probes	108

## N

<b>Naegele</b> Obstetrical Forceps	249
<b>Nagel</b> Micro Scissors	25
<b>Nail</b> Extraction Forceps	392
Scissors	49
Splitting Forceps	32,392
<b>Nasal</b> Scissors	41
Suction Tubes	402
<b>Naujoks</b> Wire Scissors	48
<b>Needle Cases</b>	422,428
<b>Needle Holders</b>	7,96-101
<b>Needle Holders</b> With Tungsten Carbide Inserts	412-416
<b>Needle</b> Sterilizing Cases	427
<b>Neff</b> Meniscus Knives	378
<b>Negus</b> Tonsil Forceps	86
<b>Nelaton</b> Directors	107
<b>Nelson</b> Lung Dissecting Forceps	65
Lung Grasping Forceps	290
Trocars	208
<b>Nelson-Metzenbaum</b> Dissecting Scissors	38
<b>Nerve and Vessel</b> Hooks	115-116
<b>Neubuser</b> Tubal Seizing Forceps	236
<b>Neuro-Surgery</b> Scissors	40
<b>Nissen</b> Dissecting and Ligature Forceps	87
Gall Duct Forceps	194
<b>Non-Traumatic</b> Haemostatic Forceps	267,268
<b>Norfolk and Norwich</b> Retractors	155
<b>Noto</b> Ovum Forceps	231
Sponge Holding Forceps	71
<b>Novak-Schoeckaert</b> Endometrial Biopsy Curettes	237
<b>Noyes</b> Micro Spring Scissors	23
<b>Nurse's</b> Scissors	50
<b>Nussbaum</b> Intestinal Clamps	179

## O

<b>Obstetrical</b> Forceps	247,249,250-254
Pelvimeters	246
Scissors	45,248
<b>Obstetric</b> Instruments	246-254
<b>Ochsner</b> Aorta Clamps	281
Gall Duct Probes	197
Ligature Forceps	58
Trocars	208
<b>Oehler</b> Dissecting Forceps	412

<b>Oldberg</b> Rongeurs	317
<b>Olivecrona</b> Bone Rongeurs	368
Dura Scissors	40
Trigeminal Knife	17
Wire Saws	323
<b>Ombredanne</b> Mallets	350
<b>Operating</b> Scissors	43,44,405
<b>Organ and Grasping</b> Forceps	70,71,74,170,171
<b>Osteotomes</b>	351-356
<b>Osteophyte</b> Rongeurs	318
<b>Otoscope</b> Complete Set	8
Battery Handle	8
<b>Overholt</b> Dissecting and Ligature Forceps	88
<b>Overholt-Geissendoerfer</b> Dissecting and Ligature Forceps	88
<b>Overholt-Mixer</b> Dissecting and Ligature Forceps	87
<b>Ovum</b> Curettes	243
<b>Ovum</b> Forceps	231,232

## P

<b>Parker</b> Retractors	123
<b>Parker-Kerr</b> Anastomosis Clamps	184
<b>Parry-Cooley</b> Aorta Clamps	288
<b>Partsch</b> Chisels	352
Gouges	352
Raspatories	331
<b>Partsch Mod.Lange</b> Raspatories	331
<b>Passow</b> Tamper	351
<b>Patent-Ductus</b> Clamps	273,288
<b>Patella</b> Forceps	358
<b>Paulsen</b> Raspatories	332
<b>Payr</b> Guiding Probes	106
Intestinal and Pylorus Clamps	183
<b>Pean</b> Haemostatic Forceps	82-84,86
Haemostatic Forceps Atraumata	268
Kidney Clamps	86,200
<b>Pederson</b> Vaginal Speculums	211
<b>Pedicle</b> Clamps	201
<b>Peet</b> Splinter Forceps	66
<b>Pelkmann</b> Uterine Dressing Forceps	225
<b>Pelvimeters</b>	246
<b>Pelvis</b> Retractors	148
<b>Pennington</b> Forceps	70
<b>Percy</b> Amputation Retractors	320
<b>Perforator</b>	254
<b>Perkins</b> Retractors	153
<b>Peripheral-Vascular</b> Clamps	274-275
<b>Percussion</b> Hammers	1
<b>Periosteum</b> Knife	319
<b>Peritoneum</b> Forceps	91
<b>Pertuiset</b> Carotid Clamps	294
<b>Phalangeal</b> Knife	319
<b>Phaneuf</b> Hysterectomy Forceps	92
<b>Piccolo</b> Cotton Applicators	109
<b>Pierce</b> Antrum Trocars	208
<b>Pinard</b> Stethoscopes	2
<b>Placenta and Ovum</b> Curettes	243,252-254
<b>Placenta</b> Pan	427
<b>Plaster</b> Breakers	397
Instruments	393
Knives	393
Saw	393
Scissors	51,394
Shears	395,396
Spreaders	397
<b>Plester</b> Retractors	153
Suction Tube	402
<b>Pliers</b> For Bending and Cutting Wires	387
<b>Pocket</b> Instrument Set	112-113

# ALPHABETICAL INDEX

<b>Polyaethylen Splint Material</b>	236
<b>Polypus and Ovum Forceps</b>	231,232
<b>Pool Suction Tube</b>	400
<b>Post Mortem Knives</b>	13
<b>Potts-De Martel Gall Bladder Scissors</b>	196
<b>Potts-Smith Forceps</b>	412
Needle Holders	412
Scissors	39,40,410
<b>Powder Pot</b>	427
Strewer	427
<b>Pozzi Tenaculum Forceps</b>	227
<b>Pratt Organ Grasping Forceps</b>	74
Rectal Specula	188
<b>Pressure Clamps</b>	94,184,193,276
<b>Price Thomas Bronchus Forceps</b>	295
<b>Probes</b>	106-109,385
<b>Proctoscopes</b>	189
<b>Protection Caps (Steinmann Pins)</b>	382
<b>Providence-Hospital Delicate Forceps</b>	79
<b>Punches</b>	310-312
<b>Putti Bone File</b>	341

## Q

<b>Quervain Bone Levers</b>	324
<b>Quinby Delicate Scissors</b>	29

## R

<b>Rabiner Percussion Hammer</b>	1
<b>Ragnell Scissors Flat Point</b>	26,410
<b>Ramley Sponge Holding Forceps</b>	70
<b>Randall Endometrial Biopsy Curettes</b>	237
Kidney Stone Forceps	203
<b>Rankin Delicate Forceps</b>	80
<b>Raspatories</b>	331-338
<b>Rasps</b>	339-341
<b>Razors</b>	22
Blade Holders	19
<b>Recamier Ovum Curettes</b>	243
Uterine Scoops	241
<b>Rectal Scissors</b>	46
Speculas	187-188
<b>Reill Cutting Pliers</b>	389
Drilling Chucks	383
Reposition Forceps	357
<b>Replacement Lamps</b>	10
<b>Reposition Forceps</b>	357,358
<b>Resection Knives</b>	14,319
<b>Retractors</b>	5,117,148,151-160, 164-167,308
For Cervical Spine	159,164,167
For Cervical Vertebral Column	160
For Deep Surgery	134-135,144-145
With Treangle Handles	119
<b>Reverdin Intestinal Spatula</b>	150
Needles	102
<b>Reynolds Dissecting Scissors</b>	34
<b>Rib Holding Forceps</b>	297
Raspatories	298-299
Rongeurs	297
Shears	296
Spreaders	300-303,307
<b>Ricard Abdominal Retractors</b>	162
<b>Richardson Retractors</b>	132
<b>Richardson-Eastman Retractors</b>	132
<b>Richter Vaginal Retractors</b>	220
<b>Ring Handle Bulldog Clamps</b>	264,284
<b>Robin Towel Clamps</b>	76

<b>Rochard Retractors</b>	147
<b>Rochester-Carmalt Haemostatic Forceps</b>	86
<b>Rochester-Ochsner Haemostatic Forceps</b>	84
<b>Rochester-Pean Haemostatic Forceps</b>	83
<b>Roeder Towel Clamps</b>	75
<b>Rohrschneider Needle Holder</b>	96
<b>Rollet Fine Wound Retractors</b>	117
<b>Rongeurs</b>	313-318
<b>Rose Retractors</b>	123
<b>Roser-Koenig Mouth Gag</b>	6
<b>Roettgen-Ruskin Bone Rongeurs</b>	369
<b>Round Bowls</b>	426
Handle Needle Holders	97
Metal Boxes	425
Pliers	387
<b>Roux Retractors</b>	124
<b>Rudd Haemorrhoidal Ligators</b>	193
<b>Rulers</b>	11
<b>Rumel Forceps</b>	89
<b>Rumel-Belmon Tourniquets</b>	259
<b>Ruskin Bone Rongeurs</b>	369
<b>Ruskin-Liston Bone Cutting Forceps</b>	374
<b>Russ-Modell Tissue Forceps</b>	65
<b>Rust Amputation Saws</b>	321
<b>Ryder Needle Holders</b>	414
<b>Ryder-Vascular Needle Holders</b>	414

## S

<b>Saalfeld Knife</b>	18
<b>Saddle Hooks</b>	119
<b>Saenger Ovum Forceps</b>	252,253
<b>Safety Pins</b>	76
<b>Salenius Meniscus Knives</b>	379
<b>Salpingograph</b>	260
<b>Samii Tissue Grasping, Tumors Forceps</b>	54
<b>Sarot Needle Holders</b>	414
<b>Satinsky Anastomosis Clamps</b>	293
Scissors	40
<b>Satterlee Amputation Saws</b>	322
<b>Sauerbruch Retractors</b>	129
Sterilizing Cases	428
<b>Sauerbruch-Coryllos Rib Rongeurs</b>	297
<b>Saupe Cilia Forceps</b>	66
<b>Scalp Flap Forceps</b>	251
<b>Scalpel Handles</b>	20,21
Knives	14,15,18
<b>Scaphoid Gouges</b>	351
<b>Scapula Retractors</b>	139,308
<b>Schaaf Cilia Forceps</b>	66
<b>Schaedel Towel Clamps</b>	75
<b>Schede Bone Curettes</b>	344
<b>Scheinmann Biopsy Tip</b>	240
<b>Scherback Vaginal Speculums</b>	219
<b>Schimmelbusch Ether Mask</b>	6
Sterilizing Drum	422
<b>Schink Dermatomes</b>	22
<b>Schmid Irrigation Cannulae</b>	257
Vascular Spatula	258
<b>Schmieden Guiding Probes</b>	106
<b>Schmieden-Dick Ligature Needles</b>	105
<b>Schneider Pelvimeters</b>	246
Raspatories	336
<b>Schoemaker-Loth Needle Holder</b>	100
Ligature Scissors	47
<b>Schoenborn Retractors</b>	122
<b>Schroeder Organ Grasping Forceps</b>	74
Tenaculum Forceps	227-229
Uterine Scoops	241
<b>Schubert Biopsy Forceps</b>	238





# ALPHABETICAL INDEX

<b>Schulz</b> Bioptome	260	<b>Spurling</b> Rongeurs	314,316,317
<b>Schulze</b> Salpingograph	245	<b>Sputum Cup</b>	425
<b>Schumacher</b> Biopsy Forceps	239	<b>St. Marks</b> Retractors	148
Biopsy Tips	240	<b>St. Martin</b> Forceps	62
Bone Levers	329	<b>Stacke</b> Probes	109
Sternum Shears	296	<b>Stamm</b> Bone Cutting Forceps	373
Umbilical Cord Scissors	45,248	<b>Standard</b> Dissecting Forceps	57
<b>Schumacher mod. Wagner</b> Bone Levers	329	Scissors	30,31,405
<b>Schwarz</b> Traction Bows	382	Tissue Forceps	63
<b>Scissors</b>	23-51	<b>Steinmann Pins</b>	382
With Tungsten Carbide Inserts	405-411	<b>Stellbrink</b> Bone Rongeurs	365
<b>Scoville-Richter</b> Self-Retaining Retractors	158	<b>Stelzner</b> Rectal Scissors	46
<b>Screw Driver</b>	381	<b>Sterilizing</b> Baskets/Trays	431,432
<b>Scudder</b> Stomach Clamps	182	Cases	430
<b>Sedillot</b> Raspatories	336	Drums	422
<b>Segond</b> Myomatome	17,236	Forceps	55,424
<b>Seidl</b> DBP Biopsy Forceps	239	<b>Sternal</b> Puncture Needle	208
Vaginal Specula	211	<b>Sternberg</b> Cheek and Lip Retractor	5
<b>Seiffert</b> Probes	109	Retractors	123
<b>Self Centering</b> Forceps	363	<b>Sternum Instruments</b>	296
<b>Self Retaining</b> Retractors	151-156,158	<b>Sternotomy</b> Spreaders	304-305
Laminectomy Retractors	155-156	<b>Stethoscopes</b>	2
<b>Sellers</b> Rib Spreader and Contractor	307	<b>Stevens</b> Dissecting Scissors	26,33
<b>Semb</b> Bone Holding Forceps	297,360	Needle Holders	417
Bone Rongeurs	372	<b>Stieglitz</b> Splinter Forceps	66
Dissecting and Ligature Forceps	291	<b>Stille</b> Bone Rongeurs	370
Rib Raspatories	299,337	Chisels	353
Rib Rongeurs	297	Dissecting Scissors	37
<b>Semken</b> Delicate Forceps	56,62,411	Gouges	353
<b>Semm</b> Abdominal Retractors	166	Kidney Clamps	201
Vaginal Specula	210	Osteotomes	353,354
<b>Senn-Miller</b> Retractors	123	Plaster Shears	395,396
<b>Sequestrum</b> Forceps	359	<b>Stille-Barraya</b> Dissecting Forceps	170
<b>Seutin</b> Plaster Scissors	51,394	<b>Stille-Ruskin</b> Bone Rongeurs	370
<b>Sewall</b> Raspatories	332	<b>Stomach</b> Clamps	182
<b>Seyffert</b> Vaginal Specula	210	<b>Storing Cases</b>	422,429,430
<b>Siebold</b> Uterine Scissors	44	<b>Strack</b> Scissors	48
<b>Sigmoid</b> Anastomosis Forceps	185-186	<b>Strainer</b> for Tissues	244
<b>Silicone</b> Operating Pad	236	<b>Stratte</b> Needle Holders	414
<b>Silver</b> Dermatomes	22	<b>Strassburger</b> Tissue Forceps	65
<b>Simon</b> Bone Curettes/Scoops	241,346	<b>Strassmann</b> Elevating Forceps	234
Fistula Hooks	121	<b>Strully</b> Scissors	40
Retractors	121,135	<b>Subrammanian</b> Aorta Clamps	280
Uterine Scoops	241	<b>Suction</b> Cannula	309,400,401,404
Wound Retractors	218	Curettes	244
<b>Simplex</b> Cheek and Lip Retractor	5	Handles	399
<b>Simpson</b> Obstetrics Forceps	250	Hose Connection	244
Uterine Probes	224	Instruments	309,398-404
<b>Simpson-Braun</b> Obstetrics Forceps	249,250	Raspatories	402
<b>Sims</b> Gynaecological Scissors	43,409	Tubes	309,400-404
Rectal Specula	187,188	<b>Surgical</b> Scissors	30-32,405
Uterine Curettes	242	<b>Suture</b> Hook	106
Uterine Probes	224	Instruments	102-104
Vaginal Specula	211	Scissors	411
<b>Sims-Maier</b> Sponge Forceps	69	<b>Suture Instrument Sets</b>	112
<b>Sims-Siebold</b> Uterine Scissors	44	<b>Swab Holder</b>	191
<b>Skin</b> Retractors	117	<b>Swedish Pattern</b> Forceps	58
<b>Smellie</b> Perforator	254	<b>Syme</b> Suture Needle	104
<b>Smillie</b> Meniscus Knives	379	<b>Synovectomy</b> Rongeurs	365
<b>Smith</b> Bandage Scissors	49	<b>Sypert</b> Bone Curettes With Hartpress Handle	347
<b>Somer</b> Elevating Forceps	234	<b>Systrunk</b> Nail Splitting Scissors	32,392
<b>Spatulas</b>	109		
<b>Special</b> Bone Levers	330		
Retractors	157		
<b>Spencer</b> Ligature Scissors	47		
<b>Spencer-Wells</b> Haemostatic Forceps	83		
<b>Sphincteroscopes</b>	189		
<b>Splint</b> Guide	236		
<b>Splinter</b> Forceps	66		
<b>Sponge</b> Forceps	67-71		
Holding Forceps	70-71		

## T

<b>Tablet Tray</b>	425
<b>Tager</b> Special Bone Levers	330
<b>Takahashi</b> Rongeurs	313
<b>Tampers</b>	351
<b>Tangential Occlusion</b> Clamps	271-272
<b>Taylor</b> Percussion Hammer	1



# ALPHABETICAL INDEX

<b>Teale</b> Tenaculum Forceps	229	<b>Unna</b> Extractor	18
<b>Tendon</b> Hooks	121	<b>Ureter</b> Forceps	205
Interlacing Forceps	72	<b>Urethral</b> Bougies Urinary Instruments	206
Seizing Forceps	72	<b>Uterine</b> Curettes	241,242
<b>Tenotomes</b>	14-15	Depressor	224
<b>Tessier</b> Bone Curettes	346	Dilators	221,222
<b>Thole</b> Pelvimeter	246	Dressing Forceps	225,226
<b>Thoms-Gaylor</b> Biopsy Forceps	238	Elevating Forceps	233-235
<b>Thoracic</b> Retractors	306	Flushing Tube	245
<b>Thorek</b> Scissors	40	Probes	224
<b>Thorpe</b> Corneal Forceps	55	Scissors	43,44,409
<b>Thyroid</b> and Vaginal Retractors	157,220	Scoops	241
<b>Tiemann</b> Organ Grasping Forceps	74	Secretion Scoop	237
<b>Tissue</b> Forceps	62-65	Tenaculum Forceps	227-230
Grasping Forceps	54,70,71,73,74, 168,170,171	<b>US-Army</b> Retractors	124
<b>Tobold</b> Tongue Depressor	5		
<b>Toennis</b> Dissecting Scissors	34	<b>V</b>	
Fine Wound Retractors	117	<b>Vacuum</b> Curettes	244,398
Needle Holders	100	<b>Vaginal</b> Clamps	93-94
Vascular Spatulas	258	Retractors	157,217,218,220
<b>Toennis</b> Wire cutting Plier with T.C	421	Speculas	209-219
<b>Toennis-Adson</b> Dissecting Scissors	34	Vaginal and Wound Retractors	218
<b>Tongue</b> Depressors	5	<b>Van Buren</b> Bone Holding Forceps	359
Forceps	6	<b>Vannas</b> Micro Spring Scissors	23,24
<b>Tourniquets</b>	259	<b>Vario</b> Retractors	136,137,215
<b>Tonsil</b> Dissector	402	<b>Vascular</b> Dilators	257
Forceps	86	Spatulas	258
Knives	17	<b>Vein</b> Retractors	122
Scissors	41	<b>Vena Cava</b> Clamps	270,271,293
<b>Towel Clamps</b>	75,76	<b>Venae Sectio</b> Set	113-114
<b>Townley</b> Caliper	11	<b>Verbrugge</b> Bone Holding Forceps	363
<b>Trachea</b> Retractors	118	<b>Verbrugge-Muller</b> Bone Levers	328
<b>Tracheal</b> Dilators	256	<b>Vernier</b> Caliper	11
Hooks	256	<b>Vessel</b> Clamps	292
Tubes	255	Hooks	115,116
<b>Traction</b> Bows	382	Irrigation Cannulae	257
Hooks	380	Scissors	39
<b>Transformer</b>	4	<b>Vidal</b> Lupus Scraper	18
<b>Transparent</b> Suction Hose	244	<b>Virchow</b> Knife	13
<b>Trays</b>	426,430	<b>Vise</b> Grip Pliers	387
<b>Trelat</b> Raspatories	331	Micro Forceps	52
<b>Triangular</b> Basins	427	<b>Volkmann</b> Bone Curettes	342,344
<b>Trigeminal</b> Knife	17	Bone Retractors	125,126
<b>Trocars</b>	208,398,399		
<b>Troeltsch</b> Forceps	61	<b>W</b>	
<b>Troemner</b> Percussion Hammer	1	<b>Wachenfeldt</b> Clip Applying Forceps	111
<b>Trousseau</b> Tracheal Dilators	256	<b>Wagner</b> Vessel Hooks	115
<b>Troutman-Chris</b> Blade Holder	19	<b>Wagner</b> Bone Levers	327
<b>Tubal</b> Seizing Forceps	236	Mallets	349
<b>Tubbs</b> Aortic Dilators	260	Meniscus Knives	378
<b>Tuffier</b> Intestinal Spatula	150	Raspatories With Hartpress Handle	338
Rib Spreaders	300	Rongeurs	318
Tissue Grasping Forceps	168	<b>Walb</b> Knife	13
<b>Tungsten Carbide Instruments</b>	405-419	<b>Walter</b> Gouges	353
<b>Tunnelling</b> Instruments	261	<b>Wangenstein</b> Forceps	412
<b>Turnable</b> Biopsy Forceps	190	Intestinal Grasping Forceps	170
<b>Tuttle</b> Lung Dissecting Forceps	65	Needle Holders	99
Lung Grasping Forceps	290	Pinwheel	1
<b>U</b>		<b>Wartberg</b> Tissue Forceps	64
<b>Ueckermann-Denker</b> Cryothyrotomy Trocar	255	<b>Weber</b> Aorta-Anastomosis Clamps	282
<b>Uffenorde</b> Bone Curettes	343	<b>Webster</b> Needle Holders	98
<b>Ultra-Light</b> Forceps	59,172,262	<b>Wecker</b> Eye Scissors	23
<b>Umbilical</b> Cord Scissors	45,248	<b>Weil-Blakesley</b> Rongeurs	313
<b>Universal</b> Bandage Scissors	50	<b>Weissbarth</b> Vaginal Speculum	217
Handle	240	<b>Weitianer</b> Self-Retaining Retractors	152-153
Trays	430	<b>Weiler</b> Meniscus and Cartilage Forceps	377
Trocars	208	<b>Wertheim</b> Anastomosis Clamps	275
Wire Cutting Scissors	48,388,411		

# ALPHABETICAL INDEX

Clamps and Forceps	92-95,201
Gynaecological Scissors	43
Hysterectomy Forceps	92
Parametrium Clamps	93
<b>Wertheim-Cullen</b> Clamps and Forceps	95
<b>Wieder</b> Tongue Depressor	5
<b>Wiener Modell</b> Suture Hooks	106
<b>Wikstroem</b> Dissecting and Ligature Forceps	291
<b>Wilde</b> Forceps	61
<b>Willett</b> Scalp Flap Forceps	251
<b>Williams</b> Intestinal Grasping Forceps	170
Lung Grasping Forceps	290
<b>Williger</b> Bone Curettes	342,344
Elevators	324
Raspatories	331
Retractors	120
<b>Winter</b> Ovum Forceps	252
<b>Wire</b> Catcher	385
Cutters	388
Cutting Pliers	387,389,391,421
Cutting Scissors	48,388,411
Extensions	380,381
Guides	384
Holding Forceps	386,387
Saws	323
Tightener	380,383,385
Tightening Pliers	386
Traction Bow	380,381
Twister	385
<b>Winkelmann</b> Circumcision Clamps	207
<b>Wolff</b> Plaster Breakers	397
<b>Wound</b> Retractors	117-118,122
<b>Wound and Tracheal</b> Hooks	256
<b>Wrenches</b>	380
<b>Wrigley</b> Obstetrics Forceps	250
<b>Wulstein</b> Self-Retaining Retractors	153
Suction Tube	403

## Y

<b>Yankauer</b> Suction Cannulae	309,401
<b>Yasargil</b> Ligature Forceps	53,87
Micro Forceps	53
Micro Needle Holders	96,97,420
Micro Scissors Bayonet Shape	25
Rongeurs	317
Suction Cannulae	309,403,404
Tumor & Vessel Forceps	54

## Z

<b>Zenker</b> Forceps	89
Retractor	139
<b>Ziegler</b> Head band	3
Head Mirror	3
Milium Knives	18
<b>Zielke</b> Gouges	335



**AllWell Instruments co.**

The name of Health Cure Instruments

Surgical Instruments Manufacturer, Wholesaler & Exporter

Email : [Info@allwellinst.com](mailto:Info@allwellinst.com)  
[Imranasghar65@gmail.com](mailto:Imranasghar65@gmail.com)

Tel : +92-52-3242356  
+92-321-6121965

Fax : +92-52-3550433

Address : Sardar Pura, Defence road, Muzafar Pur  
S.I.E 51340, Sialkot, Pakistan